

TRAMONTINA

# NEW INOX BASIC 60 F4



# FORNO ELÉTRICO NEW INOX BASIC 60 F4

Ref.: 94864/320

TRAMONTINA



USO EXCLUSIVAMENTE DOMÉSTICO

CAPACIDADE

— 71 L

LÂMPADA PARA ILUMINAÇÃO INTERNA

(melhor visualização do alimento)

5 POSIÇÕES PARA GRELHA E BANDEJA

PORTA COM 3 VIDROS TEMPERADOS

AÇO INOX COM TRATAMENTO ANTI-DIGITAIS

TIMER COM DESLIGAMENTO AUTOMÁTICO

TENSÃO

— 220 V

FREQUÊNCIA

— 50 - 60 Hz

4 FUNÇÕES

- Assar - potência 2100 W
- Aquecimento Superior - potência 2000 W
- Aquecimento Inferior - potência 1100 W
- Grill - potência 1000 W

POTÊNCIA TOTAL

— 2100 W

TEMPERATURA MÁXIMA

—270°C



Até **24 meses**

de garantia contados a partir da data de emissão da Nfe de compra

**3 meses + 9 meses + 6 meses + 6 meses**  
garantia legal      garantia contratual      registrando o produto      instalando com o serviço autorizado Tramontina\*

Garantia Adicional Grátis

Válido somente para o Brasil. O cadastro deve ser realizado dentro do período da garantia contratual.

Caso o produto não for instalado com o serviço autorizado Tramontina, a Garantia poderá ser de até 18 meses.  
\*Instalação não gratuita.

Registre o produto em:  
[www.tramontina.net/cadastrogarantia](http://www.tramontina.net/cadastrogarantia)



Produtos certificados cfe. OCP-0029, UL, Segurança, Compulsório, Immetro

ACESSÓRIOS INCLUSOS



Bandeja coletora  
funda



Grelha

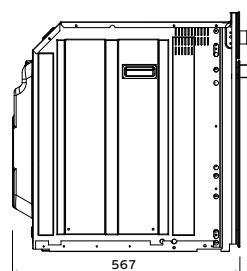
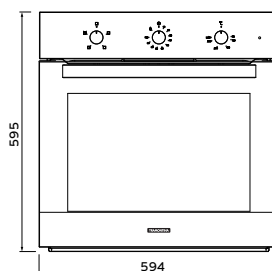

# FORNO ELÉTRICO

## NEW INOX BASIC 60 F4

Ref.: 94864/320

### Instalação modo convencional

Forno	
Modelo / Ref.:	
	94864/320

Micro-ondas	
Modelo / Ref.:	
	94880/006

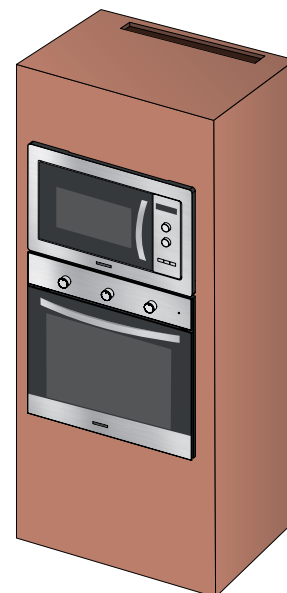
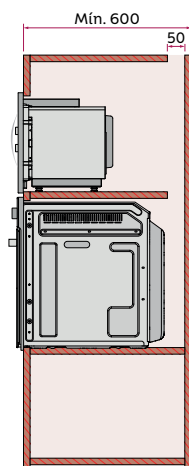
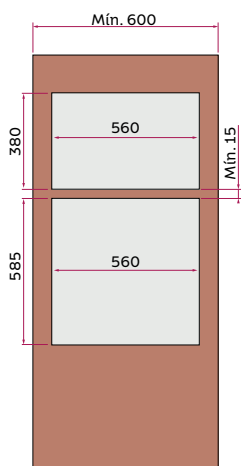
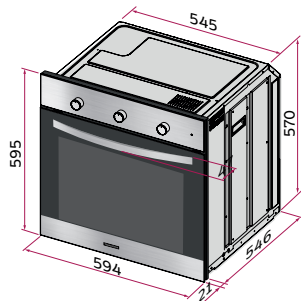
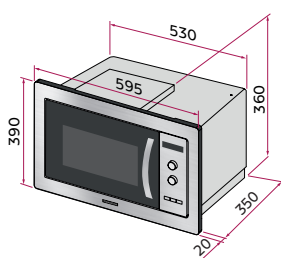

# Instalação modo Flush

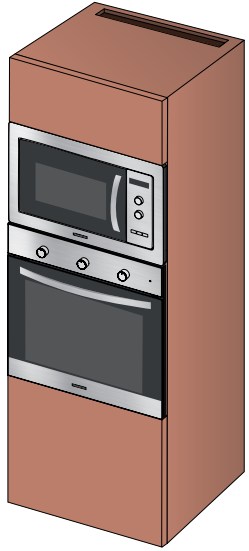
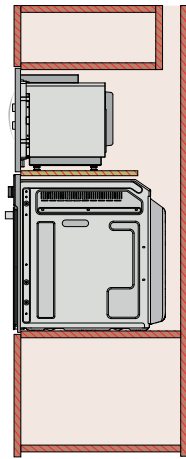
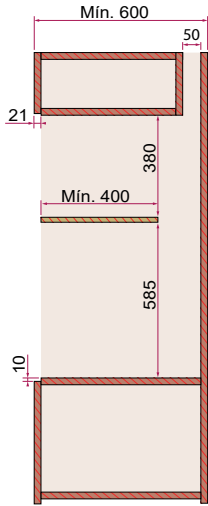
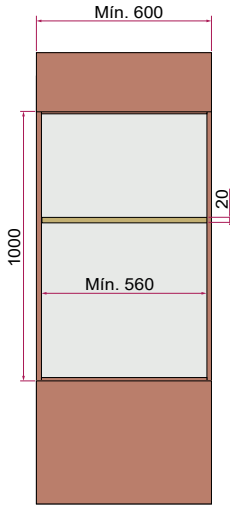
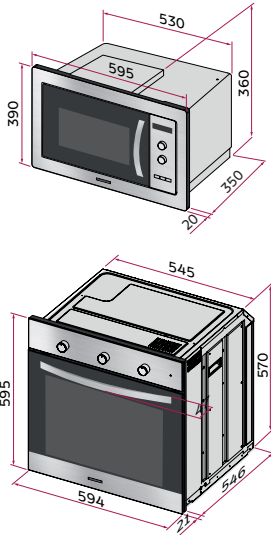

\*Somente compartilhe esse material com pessoas físicas se tiver a evidência do consentimento.  
Produto para uso interno | Arquivos BIM disponíveis em: [tramontina.com.br/biblioteca](http://tramontina.com.br/biblioteca)

A Tramontina reserva-se o direito de modificar as informações da ficha técnica do produto sem aviso prévio. Todas as imagens são meramente ilustrativas.  
Para mais informações acesse: [tramontina.com.br](http://tramontina.com.br)