

**TRAMONTINA**

**Cookware and Cutlery**  
Utilidades y Cuchillería









# THE COMPANY



Watch the video:

# LA EMPRESA



Vea el video:

More than just numbers, what truly defines Tramontina is the constant effort to make people's lives better. The small iron mill founded by Valentin and Elisa Tramontina in 1911 in southern Brazil was the beginning of a group that now encompasses 10 manufacturing units and has kept the century-old tradition of delighting people with simple gestures.

The secret for maintaining this essence is believing in people. Tramontina values each one of its over 10,000 employees so they can deliver functional, stylish products to the market, bringing inspiration to people's daily living and creating experiences to generate value and satisfy clients, consumers and communities.

All this is apparent in the more than 22,000 items that carry the values of a unique brand. Kitchen utensils and equipment, appliances, tools for agriculture, gardening, industrial and automotive maintenance, construction, electrical hardware, wood and plastic furniture, and a wide range of ride-on equipment is manufactured for the domestic market and exported to over 120 countries.

It is by doing beautiful things well that Tramontina and people are brought together. A global player, the company finds the necessary support to deliver solutions that can meet contemporary demands, combining productivity and going over and beyond targets for sustainable development through the environmental management program.

**Pleased to meet you, Tramontina!**

Más que números, lo que define a Tramontina es el esfuerzo permanente para mejorar cada vez más la vida de la gente. La pequeña herrería fundada por Valentin y Elisa Tramontina en 1911, em el sur de Brasil, originó un grupo que hoy cuenta con 10 unidades fabriles y mantiene la vocación centenaria de encantar con gestos sencillos.

El secreto para mantener la esencia es creer em las personas. Tramontina valora a cada uno de los más de 10 mil empleados para que le entreguen al mercado productos funcionales y con estilo, que inspiran el día a día y estimulan experiencias para generar valor y satisfacción a clientes, consumidores y comunidades.

Todo eso se traduce en los más de 22 mil artículos que llevan los valores de una marca única. Utensilios y equipos de cocina, electrodomésticos, herramientas para agricultura, jardinería, mantenimiento industrial y automovilístico, construcción civil, materiales eléctricos, muebles de madera o de plástico, además de la amplia línea de equipos dirigibles, que se fabrican para el mercado nacional y de exportación para más de 120 países.

Es en el hacer bien las cosas que se encuentran Tramontina y las personas. Actuando de forma global, la marca tiene el soporte necesario para entregar soluciones capaces de atender las necesidades de su tiempo, aliando productividad y superación de metas de desarrollo sustentable por medio del programa de gestión ambiental.

**¡Encantada, Tramontina!**



Respect for the environment is part of our history.  
**Watch the video:**



El respeto al medioambiente es parte da nuestra historia.  
**Vea el video:**



# CUTE LARIA

A more beautiful and practical kitchen. An unforgettable dish. A more engaging barbecue party. With multiple possibilities, Tramontina Cutelaria's mix of products and utensils offers all you need for those occasions which give life a sweeter taste.

Tramontina Cutelaria was founded in Carlos Barbosa, in the state of Rio Grande do Sul, in 1911. It now has an industrial area of over 332.000 m<sup>2</sup>, more than 3,700 employees and manufactures a wide range of products, including kitchen knives, sports knives, professional knives, machetes, pocket knives, daily use flatware, kitchen utensils, cookware, nonstick baking molds, frying pans, scissors, cheese and wine line, skewers and a complete line of barbecue products.

All items strive for quality, functionality, practicality, and an innovative design. Tramontina Cutelaria was the very first Tramontina unit which is how the organization began. It has been focused on manufacturing products to make people's lives better for 111 years.

Una cocina más práctica y bonita. Un platô inolvidable. Un asado más cálido. Con múltiples posibilidades, el mix de productos y utensilios de Tramontina Cutelaria ofrece todo lo que se precisa para las ocasiones que hacen la vida más sabrosa.

Tramontina Cutelaria, fundada en 1911, está ubicada en Carlos Barbosa, Rio Grande do Sul. Hoy, con 332.000 m<sup>2</sup> de área construida, esta unidad fabril cuenta con más de 3.700 empleados que se ocupan de un amplio mix de productos: cuchillos de cocina, cuchillos deportivos, cuchillos profesionales, machetes, navajas, cubiertos de uso diario, utensilios de cocina, ollas, asaderas y sartenes antiadherentes, tijeras, línea de quesos y vino, pinchos y toda una línea completa de productos para asado.

Todos los productos priman por la calidad, funcionalidad, practicidad y por la innovación en el diseño. Tramontina Cutelaria es la primera unidad fabril de Tramontina – empresa que dio origen a la organización Tramontina – y hace 111 años viene fabricando productos para hacer que el día a día de las personas sea mejor.

Watch the vídeo:



Vea el video:







# INDEX | INDICE

## 10

### Churrasco



## 44

### Flatware Cubiertos



- 46. Polywood
- 49. Tradicional
- 50. Dynamic
- 51. Leme
- 54. New Kolor
- 56. Ipanema
- 59. Tulum
- 61. Plenus
- 63. Bliss
- 64. Carmel
- 65. Pizza
- 66. Malibu
- 68. Búzios

## 70

### Knives Cuchillos



- 76. Polywood
- 79. Verttice
- 80. Tradicional
- 83. Dynamic
- 86. Carbon
- 87. Colorcut
- 88. Plenus
- 95. Affilata
- 97. Multicolor
- 99. Ultracorte
- 102. Premium
- 104. Nygma
- 106. Century
- 114. Sushi
- 118. Cronos
- 120. Professional Knives |  
Cuchillos Profesionales
- 133. Profio
- 134. Pocket knives | Navajas
- 135. Sports knives | Cuchillos  
Deportivos

## 138

### Utensils Utensilios



- 140. Polywood
- 142. Professional |  
Profesionales
- 145. Moldê
- 147. Live
- 148. Verano
- 153. Fluence
- 155. Utilità
- 161. Ability
- 164. Movin
- 166. Apiciatta
- 167. Lyon

## 168

### Harmoniza



## 174

### Scissors Tijeras



- 176. Monstercort
- 178. Professional |  
Profesionales
- 179. Supercort
- 181. Professional |  
Profesionales

## 182

### Children Infantil



- 184. Le Petit
- 185. Baby Friends
- 187. Lirous

**188** **Mixcolor**



**192** **Starflon**

**194** **Starflon Max**



- 196. Brasil
- 199. Vermont
- 201. Turim
- 204. Loreto
- 211. Paris
- 220. Vermont
- 223. Kettles | Teteras

**226** **Starflon Excellent**



- 228. Sicília

**230** **Starflon Premium**

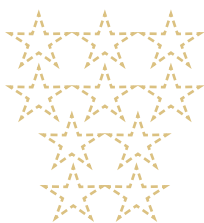

- 232. Mônaco Induction
- 235. Refinatta

**236** **Starflon High Performance**

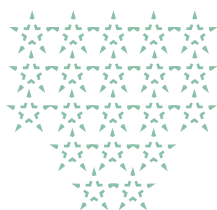

- 238. Lyon

**240** **Ceramic  
Cerámico**



- 242. Ítria
- 243. Évora

**244** **Professional  
Frying Pans  
Sartenes  
Profesionales**



**250** **Pressure Cooker  
Olla de Presión**



- 252. Vancouver
- 253. Vancouver Spot
- 254. Torino
- 255. Valência Black
- 256. Valência

**258** **Iron Sauce Pans  
Ollas de Hierro**



- 260. Trento

**262** **Themed  
Projects  
Proyectos  
Temáticos**



- 264. Power Up
- 267. My Lovely Kitchen

**270** **Informations  
La Información**

- 270. Packaging Types |  
Tipos de Embalaje
- 272. Product Number Index |  
Índice Numérico
- 281. Notes | Notas
- 284. Informations |  
La información

# CHURRASCO

**THERE IS NO INCORRECT DAY TO HAVE A BARBECUE, BUT TRAMONTINA HAS PRODUCTS FOR ALL OF THEM. | NO HAY UN DÍA MEJOR QUE OTRO PARA HACER UN ASADO Y PARA CADA UNO ESTÁN LOS PRODUCTOS TRAMONTINA.**

Tramontina has a complete barbecue line so that you have everything you need when grilling your favorite cuts and vegetables. We have skewers, grills, knives, cutting boards, flatware, and many utensils to help make everyone's mouth water. Now, just light the fire.

Tramontina cuenta con una línea completa para asado, para que obtenga todo lo que necesita a la hora de cocinar sus cortes y vegetales preferidos. Hay pinchos, parrillas, cuchillos, tablas, cubiertos y diversos utensilios que ayudan a que a todos se les haga agua en la boca. Ahora sólo tiene que encender el fuego.

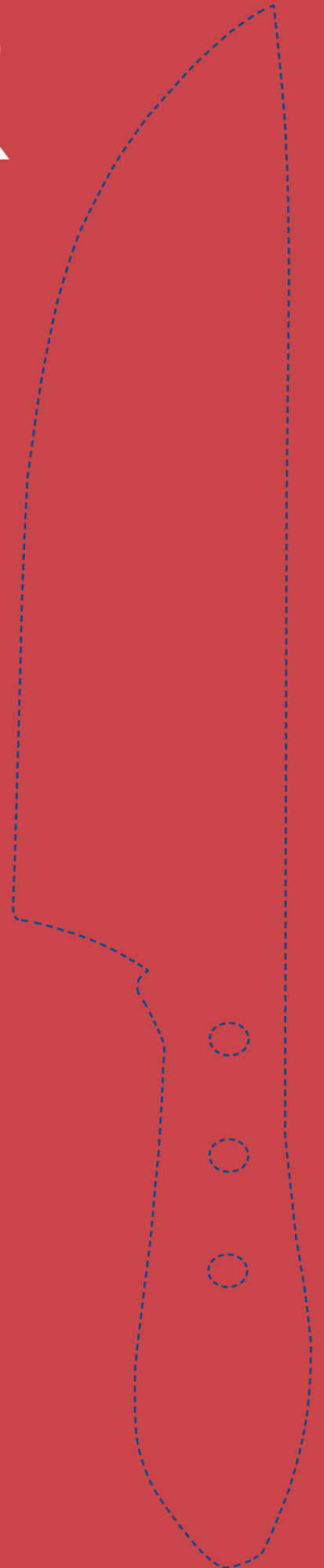









# CHURRASCO

It is time to go beyond the limits of the grill. After all, barbecue is much more than preparing food, it enhances everything around you. Friendships, singing, soccer, everything is better with a barbecue. The lighter, the charcoal, and the ember ignite much more than just the barbecue grill. It is the barbecue grill that lights up everything around it. And Tramontina has exactly what you need to make your barbecue and your moments more special.

Llegó el momento de superar los límites de la parrilla. Porque el asado, en definitiva, es mucho más que preparar alimentos; potencia las cosas a su alrededor. Las amistades, la música, el fútbol, todo es mejor cuando hay asado. El encendedor, el carbón y las brasas encienden mucho más que el grill a carbón. Es el grill a carbón que enciende todo a su alrededor. Y Tramontina tiene exactamente lo que necesita para hacer su asado y sus momentos aún más especiales.



watch the video



vea el vídeo

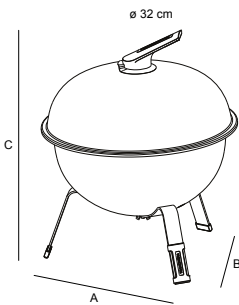

### TCP-320L Charcoal barbecue grill / Grill a carbón

Ref.	un.	Kg	m <sup>3</sup>	789.1112.	packaging empaque
26500/003	01	4,55	0,050	21956.4	

- \*A= 36,7 cm
- \*B= 37,1 cm
- \*C= 44,1 cm



watch the video



vea el vídeo

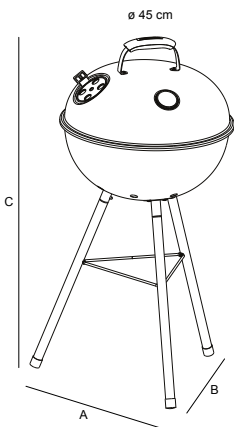

### TCP-450L Charcoal barbecue grill / Grill a carbón

26500/009	01	8,10	0,088	21954.0	
-----------	----	------	-------	---------	--

- \*A= 51,6 cm
- \*B= 53,4 cm
- \*C= 97,3 cm



watch the video



vea el vídeo

**NEW | NUEVO**

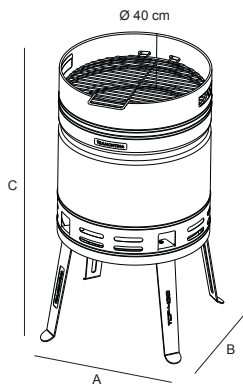

**TCP-400**  
**Charcoal barbecue grill / Grill a carbón**

Ref.	un.	Kg	m <sup>3</sup>	789.1112.	packaging empaque
26500/006	01	9,62	0,112	26414.4	

\*A= 40,4 cm  
\*B= 45,9 cm  
\*C= 76,2 cm



check out the product in augmented reality /  
vea el producto en realidad aumentada

**NEW | NUEVO**



**TCP-400**  
**Lid for charcoal grill / Tapa para grill a carbón**

26500/065	02	3,45	0,027	31252.4	
-----------	----	------	-------	---------	--



check out the product in augmented reality /  
vea el producto en realidad aumentada

**NEW | NUEVO**



**TCP-400**  
**Pizza stone / Piedra para pizza**

26500/066	01	2,05	0,006	31256.2	
-----------	----	------	-------	---------	--



check out the product in augmented reality /  
vea el producto en realidad aumentada

**NEW | NUEVO**



**Pizza spatula / Espatula para pizza**

26596/100	06	3,35	0,023	31243.2	
-----------	----	------	-------	---------	--



watch the video



vea el vídeo

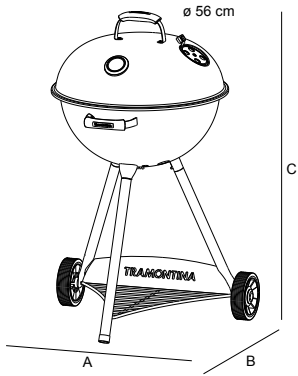

**TCP-560L**  
Charcoal barbecue grill / Grill a carbón

Ref.	un.	Kg	m <sup>3</sup>	789.1112.	packaging empaque
26500/011	01	13,15	0,180	24027.8	

\*A= 64,6 cm  
\*B= 64,5 cm  
\*C= 104 cm



**TCP-560L**  
Grill support for skewers / Anillo para pinchos - ø 56 cm

26500/029	01	2,13	0,045	20748.6	
-----------	----	------	-------	---------	--

Suitable for Tramontina skewers of 75 cm.  
Para pinchos Tramontina con largo total de 75 cm.

**NEW | NUEVO**



**TGP-6000**  
Skewer holder / Soporte para pinchos

26500/061	02	3,32	0,027	30071.2	
-----------	----	------	-------	---------	--

Suitable for Tramontina skewers of 55, 65 and 75 cm.  
Para pinchos Tramontina con largo total de 55, 65 y 75 cm.



watch the video



vea el vídeo

**NEW | NUEVO**



check out the product  
in augmented reality /  
vea el producto en  
realidad aumentada

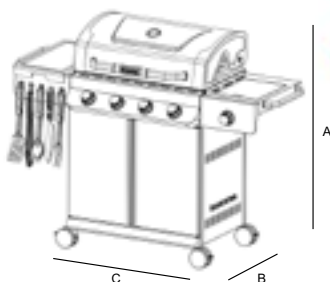

**TGP-6000**  
Gas grill with utensils / Grill a gas con utensilios

26500/021*	01	61,70	0,553	29656.5	
------------	----	-------	-------	---------	--

CONTENTS / CONTENIDO

- 1 - TGP-6000 - Gas barbecue grill / TGP-6000 Grill a gas
- 1 - 13508/100 - Cutting board / Tabla para cortar (53,8 x 29,4 cm)
- 1 - 26590/008 - 8" Carving knife / Cuchillo trinchante 8"
- 1 - 26591/000 - Carving fork / Tenedor trinchante
- 1 - 26592/000 - Spatula / Espátula
- 1 - 26593/000 - Meat tong / Pinza para carne
- 1 - 26594/000 - Brush / Cepillo

\*A= 116,6 cm  
\*B= 58,4 cm  
\*C= 155,5 cm

NEW | NUEVO



**TGP-6000**  
Cover / Cubierta para grill

Ref.	un.	Kg	m <sup>3</sup>	789.1112.	packaging empaque
26500/062*	01	2,78	0,013	30273.0	



watch the video



vea el vídeo

NEW | NUEVO



**(6") Boning knife / Cuchillo para deshuesar**

22840/106	06	0,89	0,002	29674.9	
-----------	----	------	-------	---------	--

NEW | NUEVO



**(10") Butcher/Meat knife / Cuchillo butcher/carne**

22841/110	06	1,36	0,004	29678.7	
-----------	----	------	-------	---------	--

NEW | NUEVO



**(12") Slicer knife / Cuchillo slicer/rebanar**

22842/112	06	1,55	0,004	29682.4	
-----------	----	------	-------	---------	--

NEW | NUEVO



**(8") Meat knife / Cuchillo para carne**

22843/108	06	1,35	0,003	29679.4	
-----------	----	------	-------	---------	--

NEW | NUEVO



**(10") Meat knife / Cuchillo para carne**

22844/110	06	1,76	0,004	29680.0	
-----------	----	------	-------	---------	--

NEW | NUEVO



**(7") Cleaver / Hachuela**

22845/107	06	2,98	0,005	29684.8	
-----------	----	------	-------	---------	--



NEW | NUEVO



**Multipurpose claw / Garra multiuso**

Ref.	un.	Kg	m <sup>3</sup>	789.1112.	packaging empaque
22846/100	06	1,51	0,005	29686.2	☐

NEW | NUEVO



**2 pcs. Multipurpose claws / Garras multiuso 2 pzas.**

22847/100*	06	1,06	0,006	29888.0	☐
------------	----	------	-------	---------	---

CONTENTS / CONTENIDO  
2 - Multipurpose claws / Garras multiuso

NEW | NUEVO



**(8") Carving knife / Cuchillo trinchante (40,8 cm)**

26590/108	06	1,09	0,004	29663.3	▲
-----------	----	------	-------	---------	---

NEW | NUEVO



**Carving fork / Tenedor trinchante (42,2 cm)**

26591/100	06	0,98	0,004	29664.0	▲
-----------	----	------	-------	---------	---

NEW | NUEVO



**Spatula / Espátula (42,1 cm)**

26592/100	06	1,48	0,007	29665.7	▲
-----------	----	------	-------	---------	---

NEW | NUEVO



**Meat tong / Pinza para carne (45,6 cm)**

26593/100*	06	1,75	0,012	29666.4	▲
------------	----	------	-------	---------	---

NEW | NUEVO



**Grill brush / Cepillo para parrilla (40,2 cm)**

26594/100	06	1,94	0,020	29667.1	▲
-----------	----	------	-------	---------	---

NEW | NUEVO



**Brush / Pincel (40,9 cm)**

26595/100	06	1,01	0,004	29668.8	▲
-----------	----	------	-------	---------	---



check out the product  
in augmented reality /  
vea el producto en  
realidad aumentada

**NEW | NUEVO**



**2 pcs barbecue gloves set /  
Juego guantes para asado 2 pzas**

Ref.	un.	Kg	m <sup>3</sup>	789.1112.	packaging empaque
26570/000*	04	1,65	0,015	30950.0	

CONTENTS / CONTENIDO  
2 - Barbecue gloves / Guantes para asado

**NEW | NUEVO**



**Apron / Delantal**

26571/000*	03	1,63	0,012	30951.7	
------------	----	------	-------	---------	--

**NEW | NUEVO**



**Cutting board / Tabla de corte (43,4 x 30 cm)**

25058/100	05	5,51	0,011	29672.5	
-----------	----	------	-------	---------	--

**NEW | NUEVO**



**(8") Salt and pepper grinder / Molinillo para sal o pimienta**

26456/008*	04	1,06	0,004	29670.1	
------------	----	------	-------	---------	--

CAPACITY/CAPACIDAD:  
Salt/Sal: 65 g  
Pepper/Pimienta: 35 g



NEW | NUEVO



**(10") Salt and pepper grinder / Molinillo para sal o pimienta**

Ref.	un.	Kg	m <sup>3</sup>	789.1112.	packaging empaque
26456/010*	04	1,42	0,007	29671.8	☉

**CAPACITY/CAPACIDAD:**  
Salt/Sal: 95 g  
Pepper/Pimienta: 50 g

NEW | NUEVO

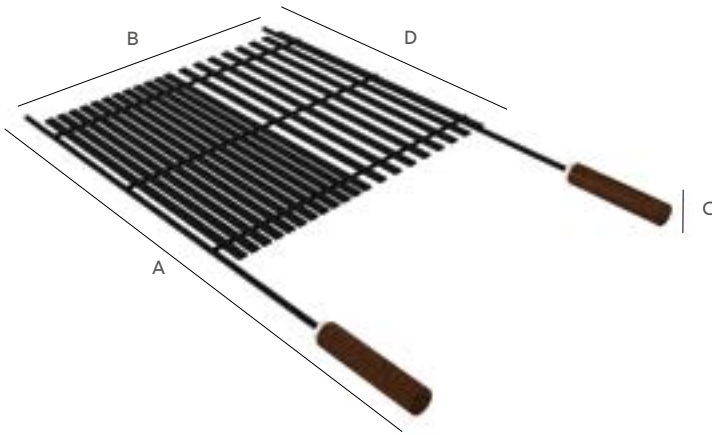

**Grill / Parrilla**

26494/000	02	6,32	0,018	29902.3	▲
-----------	----	------	-------	---------	---

\*A= 74,1 cm  
\*B= 44,2 cm  
\*C= 2,7 cm  
\*D= 42 cm

NEW | NUEVO

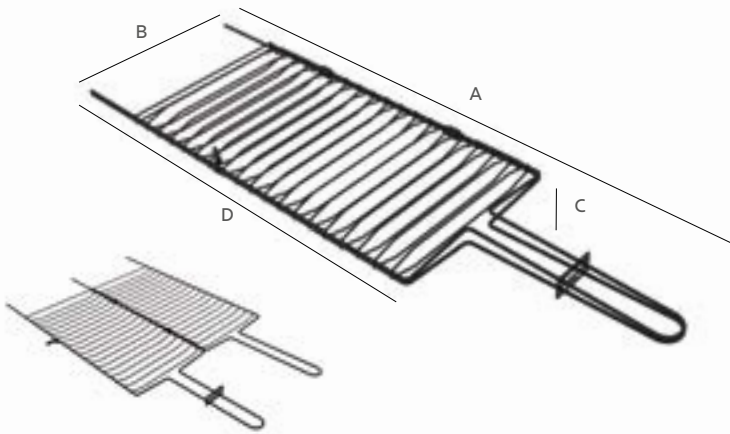

**Grill / Parrilla**

26495/000	04	3,33	0,026	29903.0	▲
-----------	----	------	-------	---------	---

\*A= 72,5 cm  
\*B= 21 cm  
\*C= 3,9 cm  
\*D= 50,5 cm

NEW | NUEVO



**Round griddle pan / Disco - ø40 cm**

20845/040	01	4,46	0,017	29904.7	■
-----------	----	------	-------	---------	---





**8 pcs. Steak / Pizza cutlery set /  
Juego de cubiertos para asado/pizza 8 pzas.**

Ref.	un.	Kg	m <sup>3</sup>	789.1112.	packaging empaque
29899/502	04	3,31	0,010	24636.2	■

CONTENTS / CONTENIDO  
 4 - 29810/106 - 4" Steak/pizza knives VANEIRA / Cuchillos para asado/pizza 4" VANEIRA  
 4 - 29810/108 - Steak/pizza forks / Tenedores para asado/pizza



**4 pcs. Steak cutlery set /  
Juego de cubiertos para asado 4 pzas.**

29899/511	03	2,01	0,009	24642.3	■
-----------	----	------	-------	---------	---

CONTENTS / CONTENIDO  
 2 - 29810/150 - 5" Steak knives BUENO / Cuchillos para asado 5" BUENO  
 2 - 29810/012 - Steak forks / Tenedores para asado



**4 pcs. Steak knives set / Juego de cuchillos para asado 4 pzas.**

29899/514	03	2,78	0,009	24644.7	■
-----------	----	------	-------	---------	---

CONTENTS / CONTENIDO  
 4 - 29810/150 - 5" Steak knives BUENO / Cuchillos para asado 5" BUENO



**4 pcs. Steak knives set / Juego de cuchillos para asado 4 pzas.**

29899/517	03	1,76	0,007	24646.1	■
-----------	----	------	-------	---------	---

CONTENTS / CONTENIDO  
 4 - 29810/023 - 4" Steak knives PAISANO - microserrated edge / Cuchillos para asado 4" PAISANO - filo con microsierra



**4 pcs. Steak cutlery set / Juego de cubiertos para asado 4 pzas.**

Ref.	un.	Kg	m <sup>3</sup>	789.1112.	packaging empaque
29899/520	03	1,69	0,007	24648.5	■

**CONTENTS / CONTENIDO**

2 - 29810/023 - 4" Steak knives PAISANO - microserrated edge /  
Cuchillos para asado 4" PAISANO - filo con microsierra  
2 - 29810/159 - Steak forks / Tenedores para asado



**4 pcs. Steak knives set / Juego de cuchillos para asado 4 pzas.**

29899/529	03	2,49	0,009	24654.6	■
-----------	----	------	-------	---------	---

**CONTENTS / CONTENIDO**

4 - 29810/143 - 5" Steak knives RIO GRANDE /  
Cuchillos para asado 5" RIO GRANDE



**4 pcs. Steak cutlery set / Juego de cubiertos para asado 4 pzas.**

29899/532	03	2,21	0,009	24656.0	■
-----------	----	------	-------	---------	---

**CONTENTS / CONTENIDO**

2 - 29810/143 - 5" Steak knives RIO GRANDE / Cuchillos para asado 5"  
RIO GRANDE  
2 - 29810/012 - Steak forks / Tenedores para asado



**3 pcs. Grill set / Juego para asado 3 pzas.**

29899/559	02	2,37	0,011	24669.0	■
-----------	----	------	-------	---------	---

**CONTENTS / CONTENIDO**

1 - 29810/077 - 8" Meat knife CAMPEIRA / Cuchillo para carne 8" CAMPEIRA  
1 - 29810/086 - Carving fork / Tenedor trinchante  
1 - 29810/149 - Meat tong / Pinza para carne



**(5") 60 pcs. Steak knives display /  
Display cuchillos asado 60 pzas.**

Ref.	un.	Kg	m <sup>3</sup>	789.1112.	packaging empaques
■ 21199/764	02	4,04	0,004	08678.4	●
■ 964				11142.4	

CONTENTS / CONTENIDO  
60 - 21100/095  
\*Sheath not included / Piezas sin vaina



**60 pcs. Table forks display /  
Display de tenedores de mesa 60 pzas.**

■ 21198/718	02	4,52	0,006	20081.4	●
■ 918				20082.1	

CONTENTS / CONTENIDO  
60 - 21102/090  
\*Sheath not included / Piezas sin vaina



**(5") 48 pcs. Jumbo steak knives display /  
Display cuchillos asado jumbo 48 pzas.**

■ 21199/749	02	9,76	0,013	05021.1	●
■ 949				11136.3	

CONTENTS / CONTENIDO  
48 - 21116/095



**48 pcs. Jumbo forks display / Display tenedores jumbo 48 pzas.**

■ 21199/769	02	5,65	0,011	11146.2	●
■ 969				11147.9	

CONTENTS / CONTENIDO  
48 - 21136/090



**(4") Steak knife / Cuchillo chuletero**

Ref.	un.	Kg	m <sup>3</sup>	789.1112.	packaging empaque
■ 21109/074	240	11,25	0,017	00160.2	
■ 094				10496.9	



**(5") Jumbo steak knife / Cuchillo para asado jumbo**

■ 21115/075	120	10,43	0,014	01340.7	
■ 095				10497.6	



**(5") Jumbo steak knife / Cuchillo para asado jumbo**

■ 21116/075	120	12,18	0,017	01468.8	
■ 095				10498.3	



**(5") Jumbo steak knife / Cuchillo para asado jumbo**

■ 21413/075	120	8,41	0,013	10511.9	
■ 095				10512.6	



**(5") Jumbo steak knife / Cuchillo para asado jumbo**

■ 29810/014	120	11,67	0,018	19779.4	
-------------	-----	-------	-------	---------	--



**Table fork - long handle / Tenedor mesa - mango largo (20,7 cm)**

■ 21110/070	240	9,96	0,017	00161.9	
■ 090				09888.6	



**Jumbo fork / Tenedor jumbo (21,5 cm)**

■ 21136/070	120	7,07	0,013	08925.9	
■ 090				10507.2	



**12 pcs. Flatware set / Juego de cubiertos 12 pzas.**

Ref.	un.	Kg	m <sup>3</sup>	789.1112.	packaging empaques
■ 21199/703				00596.9	
■ 903	10	6,10	0,034	10865.3	

**CONTENTS / CONTENIDO**

- 6 - 21100/095 - 5" Steak knives / Cuchillos asado 5"
- 6 - 21102/090 - Table forks / Tenedores mesa



**12 pcs. Flatware set / Juego de cubiertos 12 pzas.**

■ 21199/709	10	7,17	0,035	00432.0	
■ 909				10867.7	

**CONTENTS / CONTENIDO**

- 6 - 21109/094 - 4" Steak knives / Cuchillos chuletero 4"
- 6 - 21110/090 - Table forks / Tenedores mesa



**6 pcs. Steak knives set / Juego cuchillos asado 6 pzas.**

■ 21198/715	30	7,06	0,023	18994.2	
■ 915				18995.9	

**CONTENTS / CONTENIDO**

- 6 - 21100/095 - 5" Steak knives / Cuchillos asado 5"



**6 pcs. Table forks set / Juego tenedores de mesa 6 pzas.**

■ 21198/716	30	7,84	0,027	18997.3	
■ 916				18998.0	

**CONTENTS / CONTENIDO**

- 6 - 21102/090 - Table forks / Tenedores mesa



**6 pcs. Steak knives set / Juego cuchillos chuletero 6 pzas.**

Ref.	un.	Kg	m <sup>3</sup>	789.1112.	packaging empaque
■ 21109/674	30	9,08	0,034	19796.1	6
■ 694				19797.8	

CONTENTS / CONTENIDO

6 - 21109/094 - 4" Steak knives / Cuchillos chuletero 4"



**6 pcs. Forks set / Juego tenedores 6 pzas.**

■ 21110/670	30	8,89	0,034	11795.2	6
■ 690				18253.0	

CONTENTS / CONTENIDO

6 - 21110/090 - Table forks / Tenedores de mesa



**12 pcs. Flatware set / Juego de cubiertos 12 pzas.**

■ 21199/711	10	5,19	0,027	01564.7	12
■ 911				11165.3	

CONTENTS / CONTENIDO

6 - 21100/095 - 5" Steak knives / Cuchillos asado 5"

6 - 21102/090 - Table forks / Tenedores mesa



**4 pcs. Jumbo steak knives set / Juego cuchillos asado jumbo 4 pzas.**

■ 21199/731	10	4,61	0,014	02931.6	4
■ 931				11164.6	

CONTENTS / CONTENIDO

4 - 21116/095 - 5" Jumbo steak knives / Cuchillos asado jumbo 5"





**4 pcs. Jumbo flatware set / Juego de cubiertos jumbo 4 pzas.**

Ref.	un.	Kg	m <sup>3</sup>	789.1112	packaging empaques
■ 21198/708	10	3,77	0,015	15263.2	4
■ 908				15006.5	

**CONTENTS / CONTENIDO**

- 2 - 21116/095 - 5" Jumbo steak knives / Cuchillos asado jumbo 5"
- 2 - 21136/090 - Jumbo forks / Tenedores jumbo



**4 pcs. Jumbo forks set / Juego tenedores jumbo 4 pzas.**

■ 21199/797	10	2,90	0,014	13010.4	4
■ 997				13011.1	

**CONTENTS / CONTENIDO**

- 4 - 21136/090 - Jumbo forks / Tenedores jumbo



**14 pcs. Barbecue set / Juego para asado 14 pzas.**

■ 21199/789	05	5,31	0,028	12380.9	4
■ 989				12381.6	

**CONTENTS / CONTENIDO**

- 6 - 21100/095 - 5" Steak knives / Cuchillos asado 5"
- 6 - 21102/090 - Table forks / Tenedores mesa
- 1 - 21131/098 - 8" Meat knife / Cuchillo para carne 8"
- 1 - 21146/090 - Carving fork / Tenedor trinchante



**12 pcs. Jumbo flatware set / Juego de cubiertos jumbo 12 pzas.**

■ 21199/796	05	6,60	0,032	12921.4	4
■ 996				12922.1	

**CONTENTS / CONTENIDO**

- 6 - 21116/095 - 5" Jumbo steak knives / Cuchillos asado jumbo 5"
- 6 - 21136/090 - Jumbo forks / Tenedores jumbo



**12 pcs. Jumbo flatware set /  
Juego de cubiertos jumbo 12 pzas.**

Ref.	un.	Kg	m <sup>3</sup>	789.1112.	packaging empaque
■ 21198/776	05	4,32	0,020	25337.7	☐
■ 976				25338.4	

**CONTENTS / CONTENIDO**

- 6 - 21413/095 - 5" Jumbo steak knives / Cuchillos asado jumbo 5"
- 6 - 21110/090 - Table Forks / Tenedores mesa



**(10") Meat knife / Cuchillo carne**

■ 21199/722	10	3,25	0,015	00736.9	☐
■ 922				10869.1	



**(8") Meat knife with sheath / Cuchillo carne con vaina**

■ 21141/178	06	2,89	0,017	12831.6	☐
■ 198				12832.3	

**CONTENTS / CONTENIDO**

- 1 - 21141/098 - 8" Meat knife / Cuchillo para carne 8"
- 1 - Leather sheath / Vaina de cuero



**2 pcs. Barbecue set / Juego para asado 2 pzas.**

■ 21199/795	06	4,40	0,022	12827.9	☐
■ 995				12828.6	

**CONTENTS / CONTENIDO**

- 1 - 21141/098 - 8" Meat knife / Cuchillo para carne 8"
- 1 - 21144/098 - 8" Sharpener / Afilador 8"
- 1 - Leather sheath / Vaina de cuero





★ ★ ★ ★ ★  
**EXTREME**



**(8") Carving knife / Cuchillo trinchante (50,2 cm)**

Ref.	un.	Kg	m <sup>3</sup>	789.1112.	packaging empaques
26580/108	06	1,81	0,007	21936.6	▲



**Carving fork / Tenedor trinchante (47 cm)**

26581/100	06	1,61	0,007	21938.0	▲
-----------	----	------	-------	---------	---



**Multipurpose spatula / Espátula multifuncional (47,8 cm)**

26582/100	06	2,68	0,011	21940.3	▲
-----------	----	------	-------	---------	---



**Meat tong / Pinza para carne (47,3 cm)**

26583/100	06	3,58	0,019	21942.7	▲
-----------	----	------	-------	---------	---



**Grill brush / Cepillo para parrillas (44,3 cm)**

26584/100	06	3,04	0,019	21944.1	▲
-----------	----	------	-------	---------	---



**Brush / Pincel (41,8 cm)**

26585/100	06	1,97	0,010	21946.5	▲
-----------	----	------	-------	---------	---



**3 pcs. Utensils set / Juego de utensilios 3 pzas.**

26599/001	05	7,37	0,053	22791.0	■
-----------	----	------	-------	---------	---

**CONTENTS / CONTENIDO**

- 1 - 26580/008 - 8" Carving knife / Cuchillo trinchante 8" (50,2 cm)
- 1 - 26581/000 - Carving fork / Tenedor trinchante (47 cm)
- 1 - 26583/000 - Meat tong / Pinza para carne (47,3 cm)



**(5") Jumbo steak knife / Cuchillo asado jumbo**

Ref.	un.	Kg	m <sup>3</sup>	789.1112.	packaging empaque
■ 21185/075	120	13,96	0,016	17459.7	
■ 095				17460.3	



**Jumbo fork / Tenedor jumbo**

■ 21186/070	120	7,43	0,016	17462.7	
■ 090				17527.3	



**NEW | NUEVO**



**(8") Butcher knife / Cuchillo para carne**

■ 21180/178	12	2,42	0,010	31245.6	
■ 198				31244.9	



**(10") Meat knife / Cuchillo carne**

■ 21187/170	12	3,05	0,010	17775.8	
■ 190				17776.5	



**(6") Boning knife / Cuchillo deshuesar**

■ 21188/176	12	1,69	0,006	17778.9	
■ 196				17779.6	



**(8") Meat knife / Cuchillo carne**

■ 21189/178	12	2,54	0,010	17486.3	
■ 198				17487.0	



**(8") Meat knife / Cuchillo carne**

■ 21190/178	12	2,34	0,010	17489.4	
■ 198				17490.0	



**(8") Meat knife / Cuchillo carne**

■ 21191/178	12	2,67	0,010	17492.4	
■ 198				17493.1	



**Carving fork / Tenedor trinchante (30,7 cm)**

Ref.	un.	Kg	m <sup>3</sup>	789.1112.	packaging empaque
■ 21192/170	12	1,93	0,011	17781.9	1
■ 190				17782.6	



**(8") Sharpener / Afilador (32,7 cm)**

■ 21193/178	12	2,94	0,012	17784.0	1
■ 198				17785.7	



**2 pcs. Barbecue set / Juego para asado 2 pzas.**

■ 21198/760	10	4,09	0,023	17495.5	1
■ 960				17496.2	

**CONTENTS / CONTENIDO**

1 - 21189/098 - 8" Meat knife / Cuchillo carne 8"

1 - 21192/090 - Carving fork / Tenedor trinchante



**Meat tong / Pinza carne (37 cm)**

■ 21169/170	12	3,93	0,013	11253.7	▲
■ 190				11254.4	



**Meat tong / Pinza carne (37 cm)**

■ 21175/170	12	3,50	0,011	20844.5	▲
■ 190				20845.2	



**3 pcs. Barbecue set / Juego para asado 3 pzas.**

■ 21198/761	05	3,92	0,029	17498.6	1
■ 961				17499.3	

**CONTENTS / CONTENIDO**

1 - 21169/090 - Meat tong / Pinza carne (37 cm)

1 - 21189/098 - 8" Meat knife / Cuchillo carne 8"

1 - 21192/090 - Carving fork / Tenedor trinchante



**3 pcs. Barbecue set / Juego para asado 3 pzas.**

■ 21198/714	05	5,80	0,026	18948.5	1
■ 914				18949.2	

**CONTENTS / CONTENIDO**

1 - 21131/098 - 8" Meat knife / Cuchillo carne 8"

1 - 21146/090 - Carving fork / Tenedor trinchante

1 - 10435/100 - Cutting board / Tabla de madera (40 x 23 cm)



**4 pcs. Barbecue set / Juego para asado 4 pzas.**

Ref.	un.	Kg	m <sup>3</sup>	789.1112.	packaging empaque
■ 21198/764	05	7,66	0,034	17507.5	■
■ 964				17508.2	

CONTENTS / CONTENIDO

- 1 - 21189/098 - 8" Meat knife / Cuchillo carne 8"
- 1 - 21192/090 - Carving fork / Tenedor trinchante
- 1 - 21193/098 - 8" Sharpener / Afilador 8"
- 1 - 29900/554 - Wooden case / Maleta de madera



**8 pcs. Barbecue set / Juego para asado 8 pzas.**

■ 21198/765	05	16,08	0,052	17510.5	■
■ 965				17511.2	

CONTENTS / CONTENIDO

- 1 - 21175/090 - Meat tong / Pinza carne (37 cm)
- 1 - 21188/096 - 6" Boning knife / Cuchillo deshuesar 6"
- 1 - 21189/098 - 8" Meat knife / Cuchillo carne 8"
- 1 - 21190/098 - 8" Meat knife / Cuchillo carne 8"
- 1 - 21192/090 - Carving fork / Tenedor trinchante
- 1 - 21193/098 - 8" Sharpener / Afilador 8"
- 1 - 10028/100 - Cutting board / Tabla de madera (37x23 cm)
- 1 - 29900/558 - Synthetic case / Estuche sintético



**15 pcs. Barbecue set / Juego para asado 15 pzas.**

■ 21198/770	02	8,47	0,028	23801.5	■
■ 970				23802.2	

CONTENTS / CONTENIDO

- 6 - 21116/095 - 5" Jumbo steak knives / Cuchillos asado jumbo 5"
- 6 - 21136/090 - Jumbo forks / Tenedores jumbo
- 1 - 21131/098 - 8" Meat knife / Cuchillo carne 8"
- 1 - 21146/090 - Carving fork / Tenedor trinchante
- 1 - 13244/100 - Cutting board / Tabla de madera (37x23 cm)



**17 pcs. Barbecue set / Juego para asado 17 pzas.**

■ 21198/766	03	19,89	0,076	17513.6	■
■ 966				17514.3	

CONTENTS / CONTENIDO

- 6 - 21185/095 - 5" Jumbo steak knives / Cuchillos asado jumbo 5"
- 6 - 21186/090 - Jumbo forks / Tenedores jumbo
- 1 - 21175/090 - Meat tong / Pinza carne (37 cm)
- 1 - 21187/090 - 10" Meat knife / Cuchillo carne 10"
- 1 - 21192/090 - Carving fork / Tenedor trinchante
- 1 - 10024/100 - Cutting board / Tabla de madera (49x28 cm)
- 1 - 29900/555 - Wooden case / Maleta de madera



Sizes are considered total length (blade + handle).  
Tamaños se consideran largo total (hoja + mango).



### 5 pcs. Barbecue set / Juego para asado 5 pzas.

Ref.	un.	Kg	m <sup>3</sup>	789.1112.	packaging empaque
■ 21198/781	02	4,08	0,024	28289.6	■
■ 981				28290.2	

#### CONTENTS / CONTENIDO

- 1 - 21188/096 - 6" Boning knife / Cuchillo deshuesar 6"
- 1 - 21190/098 - 8" Meat knife / Cuchillo carne 8"
- 1 - 21191/098 - 8" Meat knife / Cuchillo carne 8"
- 1 - 21195/090 - Carving fork / Tenedor trinchante
- 1 - 29900/508 - Magnetic knife holder / Soporte magnético

### Skewer / Pincho para asado (55, 65, 75, 85 cm)



26417/055		1,64	0,006	21033.2	●
065	12	1,82	0,006	21034.9	
075		1,97	0,007	21035.6	
085		2,07	0,007	21036.3	

### Skewer / Pincho para asado (65, 75, 85, 95 cm)



26418/065		2,58	0,005	21037.0	●
075	12	2,89	0,007	21038.7	
085		3,18	0,007	21039.4	
095		3,42	0,010	21040.0	

### Skewer / Pincho para asado (65, 75, 85, 95 cm)



26419/065		3,60	0,007	21042.4	●
075	12	4,09	0,010	21043.1	
085		4,55	0,008	21044.8	
095		4,99	0,012	21045.5	

### 6 pcs. Skewers set / Juego de pinchos 6 pzas. (2= 20 cm, 3= 30 cm)



26499/002	20	1,90	0,010	01935.5	■
003		2,35	0,010	01936.2	



### 6 pcs. Skewers set / Juego de pinchos 6 pzas. (40 cm)

26499/005	20	5,15	0,011	01932.4	■
-----------	----	------	-------	---------	---



### Ash shovel / Pala para cenizas (37 cm)

26469/100	06	2,17	0,015	18914.0	▲
-----------	----	------	-------	---------	---



**Charcoal tong / Pinza para carbón (47 cm)**

Ref.	un.	Kg	m <sup>3</sup>	789.1112.	packaging empaque
26467/100	06	2,62	0,020	18702.3	▲



**Charcoal rake / Rastrillo para carbón (72,7 cm)**

26468/100	06	2,28	0,020	18913.3	▲
-----------	----	------	-------	---------	---



**Spatula / Espátula (48 cm)**

26441/100	12	3,80	0,013	17532.7	▲
-----------	----	------	-------	---------	---



**Multipurpose spatula / Espátula multifuncional (48 cm)**

26442/100	12	3,68	0,014	17534.1	▲
-----------	----	------	-------	---------	---



**Carving fork / Tenedor trinchante (46 cm)**

26443/100	12	2,03	0,005	17536.5	▲
-----------	----	------	-------	---------	---



**(7'') Carving knife / Cuchillo trinchante (45,8 cm)**

26444/107	12	2,20	0,005	17538.9	▲
-----------	----	------	-------	---------	---



**(8'') Carving knife / Cuchillo trinchante (47,6 cm)**

26440/108	12	2,25	0,005	19409.0	▲
-----------	----	------	-------	---------	---



**Grill brush / Cepillo para limpiar (41,6 cm)**

26445/100	12	3,38	0,024	17540.2	▲
-----------	----	------	-------	---------	---



**Meat tong / Pinza carne (37 cm)**

26446/100	12	3,52	0,021	17542.6	▲
-----------	----	------	-------	---------	---



**Meat tong / Pinza carne (100= 37 cm, 101= 47 cm)**

26400/100	12	3,49	0,012	02542.4	▲
101		4,34	0,016	11185.1	





**Apron / Delantal**

Ref.	un.	Kg	m <sup>3</sup>	789.1112.	packaging empaque
26466/100	06	1,42	0,008	17577.8	▲



**Grill brush / Cepillo para limpiar (21,6 cm)**

26460/100*	12	2,02	0,017	17567.9	▲
------------	----	------	-------	---------	---



**Grill brush / Cepillo para limpiar (44 cm)**

26461/100*	12	2,12	0,020	17569.3	▲
------------	----	------	-------	---------	---



**Marinade injector / Jeringa para inyectar adobo - 30 ml**

26462/100*	12	1,35	0,013	17692.8	I
------------	----	------	-------	---------	---



**Charcoal blower / Soprador para el carbón (25 cm)**

26479/100*	06	0,94	0,009	13693.9	○
------------	----	------	-------	---------	---



**Barbecue mitt / Guante para asado**

26463/100*	06	1,34	0,013	17573.0	▲
------------	----	------	-------	---------	---



**Salt and pepper grinder set /  
Juego de molinillo de sal y pimienta**

26499/042*	04	3,31	0,027	18689.7	■
------------	----	------	-------	---------	---

CAPACITY / CAPACIDAD:  
Salt / Sal: 200 g  
Pepper / Pimienta: 100 g



**6 pcs. Barbecue set / Juego para asado 6 pzas.**

Ref.	un.	Kg	m³	789.1112.	packaging empaque
26499/032	05	6,33	0,038	14147.6	6

CONTENTS / CONTENIDO

- 1 - 22315/908 - 8" Meat knife / Cuchillo para carne 8"
- 1 - 22945/000 - Carving fork / Tenedor trinchantante (30 cm)
- 2 - 26417/065 - Skewer / Pincho para asado (65 cm)
- 2 - 26418/065 - Skewer / Pincho para asado (65 cm)



**3 pcs. Barbecue set / Juego para asado 3 pzas.**

26499/035	10	10,08	0,067	17547.1	3
-----------	----	-------	-------	---------	---

CONTENTS / CONTENIDO

- 1 - 26447/008 - 8" Carving knife / Cuchillo trinchantante 8" (67,8 cm)
- 1 - 26448/000 - Carving fork / Tenedor trinchantante (63,3 cm)
- 1 - 26449/000 - Spatula / Espátula (61 cm)



**3 pcs. Barbecue set / Juego para asado 3 pzas.**

26499/036	05	3,76	0,023	17548.8	3
-----------	----	------	-------	---------	---

CONTENTS / CONTENIDO

- 1 - 26443/000 - Carving fork / Tenedor trinchantante (46 cm)
- 1 - 26444/007 - 7" Carving knife / Cuchillo trinchantante 7" (45,8 cm)
- 1 - 26446/000 - Meat tong / Pinza carne (37 cm)



**2 pcs. Carving set / Juego trinchantante 2 pzas.**

26499/037	10	3,98	0,024	17549.5	2
-----------	----	------	-------	---------	---

CONTENTS / CONTENIDO

- 1 - 26443/000 - Carving fork / Tenedor trinchantante (46 cm)
- 1 - 26444/007 - 7" Carving knife / Cuchillo trinchantante 7" (45,8 cm)



**2 pcs. Carving set / Juego trinchantante 2 pzas.**

26499/044	10	7,29	0,051	19410.6	2
-----------	----	------	-------	---------	---

CONTENTS / CONTENIDO

- 1 - 26439/009 - 9" Carving knife / Cuchillo trinchantante 9" (70,4 cm)
- 1 - 26448/000 - Carving fork / Tenedor Trinchantante (63,3 cm)



**3 pcs. Utensils set / Juego de utensilios 3 pzas.**

26499/045	05	3,80	0,022	19411.3	3
-----------	----	------	-------	---------	---

CONTENTS / CONTENIDO

- 1 - 26400/000 - Meat tong / Pinza carne (37 cm)
- 1 - 26440/008 - 8" Carving knife / Cuchillo trinchantante 8" (47,6 cm)
- 1 - 26443/000 - Carving fork / Tenedor trinchantante (46 cm)



**2 pcs. Carving set / Juego trinchantante 2 pzas.**

26499/046	10	4,08	0,024	19412.0	2
-----------	----	------	-------	---------	---

CONTENTS / CONTENIDO

- 1 - 26440/008 - 8" Carving knife / Cuchillo trinchantante 8" (47,6 cm)
- 1 - 26443/000 - Carving fork / Tenedor trinchantante (46 cm)





**10" Meat/butcher knife / Cuchillo carne/butcher 10"**

Ref.	un.	Kg	m <sup>3</sup>	789.1112.	packaging empaque
■ 24658/100	04	1,36	0,008	28625.2	☐
■ 110				28626.9	



**4 pcs. Knives set / Juego de cuchillos 4 pzas.**

24699/825	06	3,27	0,011	17445.0	☐
-----------	----	------	-------	---------	---

CONTENTS / CONTENIDO

- 1 - 24471/085 - 5" Boning knife / Cuchillo deshuesar 5"
- 1 - 24472/088 - 8" Meat knife / Cuchillo carne 8"
- 1 - 24473/088 - 8" Meat knife / Cuchillo carne 8"
- 1 - 22969/088 - 8" Sharpener / Afilador 8"



**4 pcs. Barbecue set / Juego para asado 4 pzas.**

23498/436	05	2,10	0,008	27533.1	☐
-----------	----	------	-------	---------	---

CONTENTS / CONTENIDO

- 1 - 23424/046 - 6" Utility knife / Cuchillo Utility 6"
- 1 - 23426/047 - 7" Meat knife / Cuchillo carne 7"
- 1 - 23427/040 - Carving fork / Tenedor Trinchante
- 1 - 22969/028 - 8" Sharpener / Afilador 8"



**2 pcs. Carving set / Juego trinchante 2 pzas.**

23498/410	10	1,68	0,009	27534.8	☐
-----------	----	------	-------	---------	---

CONTENTS / CONTENIDO

- 1 - 23426/047 - 7" Meat knife / Cuchillo carne 7"
- 1 - 23427/040 - Carving fork / Tenedor trinchante



**3 pcs. Barbecue set / Juego para asado 3 pzas.**

23498/449	05	2,36	0,019	27529.4	☐
-----------	----	------	-------	---------	---

CONTENTS / CONTENIDO

- 1 - 23426/048 - 8" Meat knife / Cuchillo carne 8"
- 1 - 26427/040 - Carving fork / Tenedor trinchante
- 1 - 25057/040 - Meat tong / Pinza para carne (30 cm)



**6 pcs. Steak knives set / Juego cuchillos para asado 6 pzas.**

Ref.	un.	Kg	m <sup>3</sup>	789.1112.	packaging empaque
22300/605	10	1,95	0,008	21694.5	6

CONTENTS / CONTENIDO  
6 - 22300/005 - 5" Steak knives / Cuchillos asado 5"



**6 pcs. Forks set / Juego de tenedores 6 pzas.**

22302/600	10	2,33	0,010	21695.2	6
-----------	----	------	-------	---------	---

CONTENTS / CONTENIDO  
6 - 22302/000 - Table forks / Tenedores de mesa



**12 pcs. Flatware set / Juego de cubiertos 12 pzas.**

22399/030	10	4,60	0,027	09119.1	12
-----------	----	------	-------	---------	----

CONTENTS / CONTENIDO  
6 - 22300/005 - 5" Steak knives / Cuchillos asado 5"  
6 - 22302/000 - Table forks / Tenedores de mesa



**(8") Meat knife / Cuchillo carne**

22938/108	12	1,78	0,006	25343.8	1
-----------	----	------	-------	---------	---



**(8") Sharpener / Afilador**

22935/108	12	2,28	0,007	28851.5	1
-----------	----	------	-------	---------	---



**2 pcs. Carving set / Juego trinchante 2 pzas.**

Ref.	un.	Kg	m <sup>3</sup>	789.1112.	packaging empaque
22399/074	10	2,51	0,014	25345.2	2

CONTENTS / CONTENIDO

- 1 - 22938/008 - 8" Meat knife / Cuchillo carne 8"
- 1 - 22939/000 - Carving fork / Tenedor Trinchante



**2 pcs. Barbecue set / Juego para asado 2 pzas.**

22399/088	10	1,90	0,007	27268.2	2
-----------	----	------	-------	---------	---

CONTENTS / CONTENIDO

- 1 - 22936/005 - 5" Boning knife / Cuchillo deshuesar 5"
- 1 - 22937/007 - 7" Meat knife / Cuchillo carne 7"



**3 pcs. Barbecue set/ Juego para asado 3 pzas.**

22399/075	05	3,22	0,023	25346.9	3
-----------	----	------	-------	---------	---

CONTENTS / CONTENIDO

- 1 - 22938/008 - 8" Meat knife / Cuchillo carne 8"
- 1 - 22939/000 - Carving fork / Tenedor trinchante
- 1 - 26436/000 - Meat tong / Pinza carne (37,4 cm)



**3 pcs. Barbecue set/ Juego para asado 3 pzas.**

22399/076	05	4,72	0,020	25347.6	3
-----------	----	------	-------	---------	---

CONTENTS / CONTENIDO

- 1 - 22938/008 - 8" Meat knife / Cuchillo carne 8"
- 1 - 22939/000 - Carving fork / Tenedor trinchante
- 1 - 13302/082 - Wooden cutting board / Tabla de madera (38,5 x 20,2 cm)

**NEW | NUEVO**



**3 pcs. Carving set / Juego trinchante 3 pzas.**

22399/089	05	5,39	0,019	27966.7	3
-----------	----	------	-------	---------	---

CONTENTS / CONTENIDO

- 1 - 22354/007 - 7" Meat knife / Cuchillo para carne 7"
- 1 - 22355/000 - Carving fork / Tenedor trinchante
- 1 - Cutting board / Tabla de corte



**10 pcs. Barbecue set / Juego para asado 10 pzas.**

Ref.	un.	Kg	m <sup>3</sup>	789.1112.	packaging empaque
22399/037	05	5,74	0,042	18951.5	

**CONTENTS / CONTENIDO**

- 4 - 22342/005 - 5" Jumbo steak knives / Cuchillos asado jumbo 5"
- 4 - 22343/000 - Jumbo forks / Tenedores jumbo
- 1 - 22344/008 - 8" Meat knife / Cuchillo carne 8"
- 1 - 22345/000 - Carving fork / Tenedor Trinchante



**15 pcs. Barbecue set / Juego para asado 15 pzas.**

22399/028	10	12,04	0,063	07689.1	
-----------	----	-------	-------	---------	---

**CONTENTS / CONTENIDO**

- 6 - 22300/005 - 5" Steak knives / Cuchillos asado 5"
- 6 - 22302/000 - Table forks / Tenedores mesa
- 1 - 22315/008 - 8" Meat knife / Cuchillo carne 8"
- 1 - 22330/000 - Carving fork / Tenedor trinchante
- 1 - 26400/000 - Meat tong / Pinza carne (37 cm)



**(5") Jumbo steak knife / Cuchillo para asado jumbo**

22213/005	120	8,44	0,014	02551.6	
-----------	-----	------	-------	---------	---



**(5") Jumbo steak knife / Cuchillo para asado jumbo**

22214/005	120	8,43	0,013	01397.1	
-----------	-----	------	-------	---------	---



**Jumbo fork / Tenedor jumbo (21,5 cm)**

22228/000	120	6,72	0,015	11149.3	
-----------	-----	------	-------	---------	---



**12 pcs. Flatware set / Juego de cubiertos 12 pzas.**

Ref.	un.	Kg	m <sup>3</sup>	789.1112.	packaging empaques
22299/009	10	4,70	0,027	01056.7	

CONTENTS / CONTENIDO  
 6 - 22200/005 - 5" Steak knives / Cuchillos asado 5"  
 6 - 22202/000 - Table forks / Tenedores mesa



**12 pcs. Flatware set / Juego de cubiertos 12 pzas.**

22299/002	10	5,65	0,032	00027.8	
-----------	----	------	-------	---------	--

CONTENTS / CONTENIDO  
 6 - 22200/005 - 5" Steak knives / Cuchillos asado 5"  
 6 - 22202/000 - Table forks / Tenedores mesa



**14 pcs. Barbecue set / Juego para asado 14 pzas.**

22299/011	05	4,27	0,022	07687.7	
-----------	----	------	-------	---------	--

CONTENTS / CONTENIDO  
 6 - 22200/005 - 5" Steak knives / Cuchillos asado 5"  
 6 - 22202/000 - Table forks / Tenedores mesa  
 1 - 22219/007 - 7" Meat knife / Cuchillo carne 7"  
 1 - 22230/000 - Carving fork / Tenedor trinchante



**12 pcs. Jumbo Flatware set /  
Juego de Cubiertos Jumbo 12 pzas.**

22299/059	05	4,96	0,028	21490.3	
-----------	----	------	-------	---------	--

CONTENTS / CONTENIDO  
 6 - 22213/005 - 5" Jumbo steak knives / Cuchillos asado jumbo 5"  
 6 - 22228/000 - Jumbo Forks / Tenedores jumbo





**2 pcs. Carving set / Juego trinchante 2 pzas.**

Ref.	un.	Kg	m <sup>3</sup>	789.1112.	packaging empaque
22299/012	10	3,44	0,023	01729.0	

**CONTENTS / CONTENIDO**

- 1 - 22218/009 - 9" Carving knife / Cuchillo trinchante 9"
- 1 - 22231/000 - Carving fork / Tenedor trinchante



**2 pcs. Carving set / Juego trinchante 2 pzas.**

22299/013	10	1,82	0,009	07688.4	
-----------	----	------	-------	---------	---

**CONTENTS / CONTENIDO**

- 1 - 22220/007 - 7" Meat knife / Cuchillo carne 7"
- 1 - 22230/000 - Carving fork / Tenedor trinchante



**3 pcs. Carving set / Juego trinchante 3 pzas.**

22299/055	10	3,40	0,016	19981.1	
-----------	----	------	-------	---------	---

**CONTENTS / CONTENIDO**

- 1 - 22220/007 - 7" Meat knife / Cuchillo carne 7"
- 1 - 22230/000 - Carving fork / Tenedor trinchante
- 1 - 22969/048 - 8" Sharpener / Afilador 8"



**3 pcs. Barbecue set / Juego para asado 3 pzas.**

22299/046	05	5,17	0,019	11172.1	
-----------	----	------	-------	---------	---

**CONTENTS / CONTENIDO**

- 1 - 22219/007 - 7" Meat knife / Cuchillo carne 7"
- 1 - 22230/000 - Carving fork / Tenedor trinchante
- 1 - 10050/100 - Wooden cutting board / Tabla de madera (33x20 cm)



**CHURRASCO**

**Grill | Parrilla**



watch the video



vea el vídeo

- \*A=Total length / Longitud total
- \*B=Width / Ancho
- \*C=Height / Altura
- \*D=Length scale / Longitud de la red

Picture merely illustrative. / Imagen meramente ilustrativa.

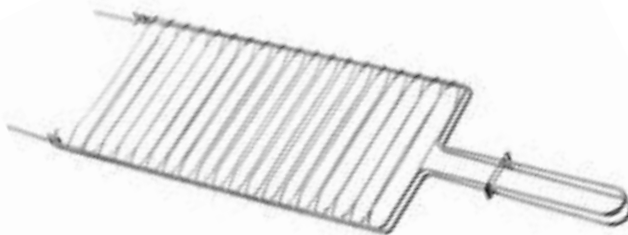
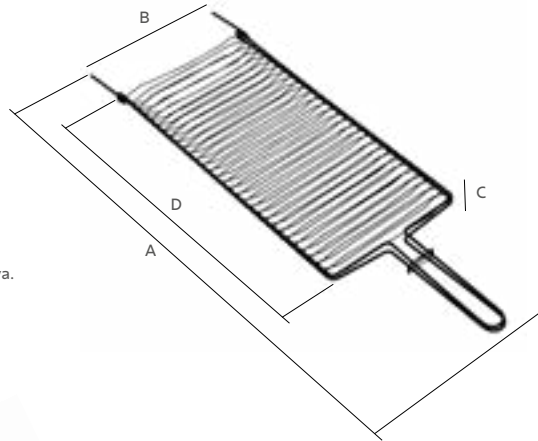

**Grill / Parrilla**

Ref.	un.	Kg	m <sup>3</sup>	789.1112.	packaging empaque
26480/001*		6,87	0,065	11199.8	
002*	06	4,62	0,042	17578.5	▲
003*		2,97	0,016	17579.2	

26480/001	26480/002	26480/003
*A=83 cm	*A=72,5 cm	*A=56 cm
*B=27,4 cm	*B=22,5 cm	*B=17 cm
*C=3,6 cm	*C=2,7 cm	*C=2,5 cm
*D=51 cm	*D=41,7 cm	*D=31 cm

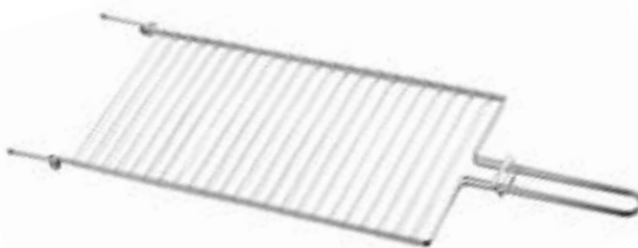

**Flat grill / Parrilla plana**

26481/002*	06	4,40	0,028	17581.5	▲
003*		3,08	0,016	17582.2	

26481/002	26481/003
*A=72,5 cm	*A=56 cm
*B=23,3 cm	*B=18,5 cm
*C=2,5 cm	*C=2,5 cm
*D=41,7 cm	*D=31 cm

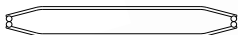

**Grill / Parrilla**

26483/000*	06	4,35	0,042	13159.0	▲
------------	----	------	-------	---------	---

*A=71,7 cm
*B=16,5 cm
*C=3,8 cm
*D=40 cm

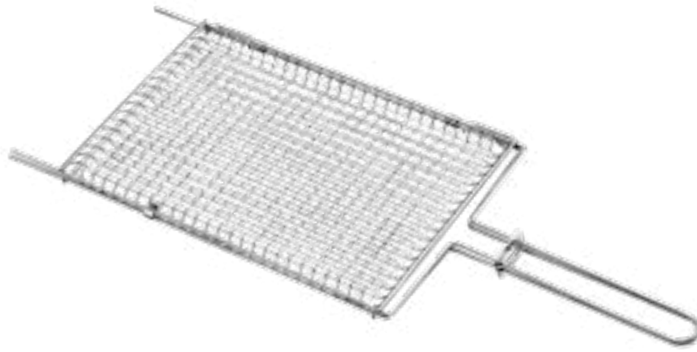

**Grill / Parrilla**

Ref.	un.	Kg	m <sup>3</sup>	789.1112.	packaging empaque
26484/000*	06	7,19	0,061	13160.6	▲

\*A=75,5 cm  
 \*B=28,1 cm  
 \*C=3,6 cm  
 \*D=41,7 cm

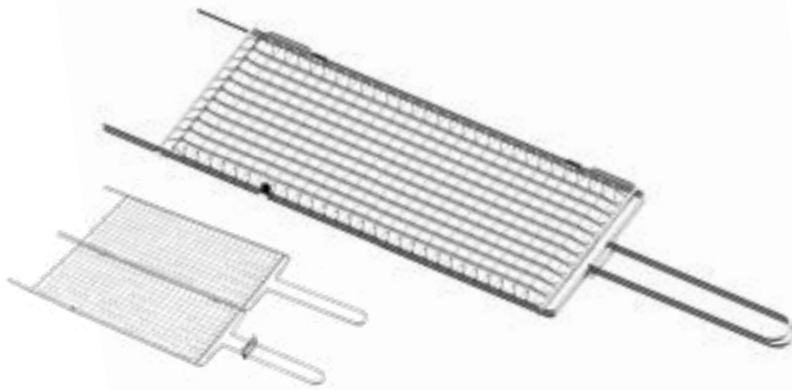

**Grill / Parrilla**

26486/000*	06	5,72	0,053	13158.3	▲
------------	----	------	-------	---------	---

\*A=76 cm  
 \*B=19,3 cm  
 \*C=3,6 cm  
 \*D=46 cm



**Grill / Parrilla**

26490/003*	06	10,87	0,069	17589.1	▲
------------	----	-------	-------	---------	---

\*A=83,5 cm  
 \*B=47,1 cm  
 \*C=3,2 cm  
 \*D=50 cm

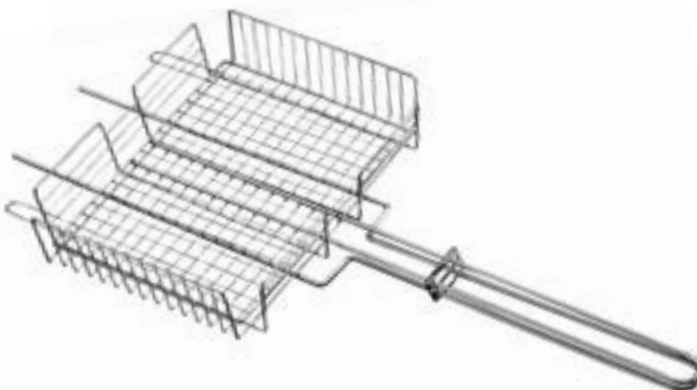

**Multi-use cooking grate / Parrilla multiuso**

26485/000*	06	6,69	0,067	13157.6	▲
------------	----	------	-------	---------	---

\*A=70,2 cm  
 \*B=31,5 cm  
 \*C=6,0 cm  
 \*D=25,6 cm

Anodized aluminum  
Aluminio anodizado



**Rectangular grill pan / Parrilla rectangular - 28 cm**

Ref.	un.	Kg	m <sup>3</sup>	789.1112.	packaging empaque
20846/028	02	1,76	0,015	28120.2	■

Anodized aluminum  
Aluminio anodizado



**Barbecue wok / Parrilla wok - ø 26 cm**

20847/026	02	1,78	0,027	27907.0	■
-----------	----	------	-------	---------	---

Anodized aluminum  
Aluminio anodizado



**Barbecue wok / Wok asado - ø 24 cm**

20848/024	02	1,74	0,021	27908.7	■
-----------	----	------	-------	---------	---

Anodized aluminum  
Aluminio anodizado



**Cooking grate / Parrilla - ø 30 cm**

20889/030	02	1,64	0,013	18685.9	■
-----------	----	------	-------	---------	---

# FLAT WARE

# CU BIERTOS

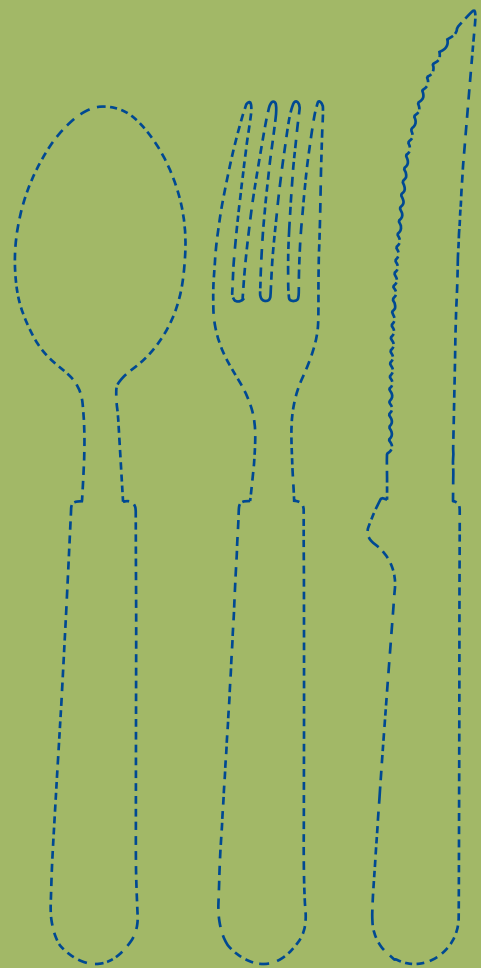

**BETWEEN DESIGN AND PRACTICALITY,  
COMPLETE THE TABLE WITH BOTH. |  
ENTRE DISEÑO Y PRACTICIDAD,  
COMPLETE LA MESA CON AMBOS.**

- 46. *Polywood*
- 49. *Tradicional*
- 50. *Dynamic*
- 51. *Leme*
- 54. *New Kolor*
- 56. *Ipanema*
- 59. *Tulum*
- 61. *Plenus*
- 63. *Bliss*
- 64. *Carmel*
- 65. *Pizza*
- 66. *Malibu*
- 68. *Búzios*

Kitchen with minimalist design and rustic flatware? Yes, you can. And for the beach house, can you choose classic flatware? But of course you can. The Tramontina flatware line is versatile precisely so people can make their mark when equipping the kitchen. With different finishes, styles and sizes, leaving the house complete and with one's style is even easier.

¿Quiere una cocina con un diseño minimalista y cubiertos rústicos? Ahora puede. Y para la casa en la playa, ¿se pueden elegir cubiertos clásicos? Pero claro que ahora se puede. La línea de Cubiertos Tramontina es versátil justo para que las personas puedan incluir su toque a la hora de equipar la cocina. Con terminaciones, estilos y tamaños diferentes, dejar la casa completa y a su manera ahora aún más fácil.







# FLAT WARE

## CUBIERTOS

### Polywood



Dishwasher safe  
Resistente al lavavajillas



5 years warranty  
5 años de garantía



Impact-resistant  
Resistente a impactos



High temperature resistant  
Resistente a altas temperaturas



Cured wood  
Madera Tratada



watch the video



vea el vídeo

### Colors | Colores



red | rojo



brown | castaño



#### (5") Steak knife / Cuchillo para asado

Ref.	un.	Kg	m <sup>3</sup>	789.1112.	packaging empaque
■ 21100/475	240	8,21	0,012	02356.7	III
■ 495	30	7,04	0,023	10804.2	6
■ 675	30	7,04	0,023	04147.9	6



NEW | NUEVO



#### (5") Steak knife / Cuchillo para asado

■ 21137/475	240	7,97	0,012	27139.5	III
■ 495	30	7,04	0,023	31285.2	6



#### (4") Table knife / Cuchillo de mesa

■ 21101/474	240	7,64	0,013	02348.2	III
■ 494	30	7,04	0,023	10806.6	6

NEW | NUEVO



#### (5") Multipurpose knife / Cuchillo multiuso

■ 29810/197	120	6,69	0,008	30044.6	III
■ 198	30	7,04	0,023	29655.8	6



#### Table fork / Tenedor de mesa

■ 21102/470	240	9,23	0,019	02349.9	III
■ 490	30	7,04	0,023	10809.7	6
■ 670	30	7,79	0,027	10810.3	6

**Table spoon / Cuchara de mesa**



Ref.	un.	Kg	m <sup>3</sup>	789.1112.	packaging empaque
■ 21103/470	240	10,02	0,019	02350.5	III
■ 490				10812.7	
■ 670	30	8,48	0,035	10813.4	6

**(3") Dessert knife / Cuchillo postre**



■ 21104/473	240	6,18	0,013	02351.2	III
■ 493				10815.8	

**Dessert fork / Tenedor postre**



■ 21105/470	240	6,65	0,013	02352.9	III
■ 490				10818.9	

**Dessert spoon / Cuchara postre**



■ 21106/470	240	7,54	0,019	02353.6	III
■ 490				10821.9	

**Tea spoon / Cuchara té**



■ 21107/470	240	6,04	0,013	02355.0	III
■ 490				10824.0	
■ 670	30	5,43	0,021	10825.7	6

**(3") Butter spreader / Espátula mantequilla**



■ 21117/473	240	6,44	0,013	11134.9	III
■ 493				11135.6	

**(3") Butter spreader / Espátula mantequilla**



■ 21160/173	60	5,17	0,024	02423.6	▲
■ 193				10849.3	





**24 pcs. Flatware set / Juego de cubiertos 24 pzas.**

Ref.	un.	Kg	m <sup>3</sup>	789.1112.	packaging empaques
■ 21199/705	10	9,84	0,047	00129.9	■
■ 905				10866.0	

CONTENTS / CONTENIDO

- 6 - 21100/075 - 5" Steak knives / Cuchillos asado 5"
- 6 - 21102/070 - Table forks / Tenedores mesa
- 6 - 21103/070 - Table spoons / Cucharas mesa
- 6 - 21107/070 - Tea spoons / Cucharas té



**6 pcs. Butter spreader set /  
Juego espátula mantequilla 6 pzas**

■ 21199/780	20	4,59	0,024	11100.4	■
■ 980				11101.1	

CONTENTS / CONTENIDO

- 6 - 21117/073





# FLAT WARE

# CU BIERTOS

## Tradicional

- stainless steel blades | láminas de acero inoxidable
- ipê wooden handles | mangos de madera natural ipê
- aluminum rivets | remaches de aluminio

### (5") Steak knife / Cuchillo para asado

Ref.	un.	Kg	m <sup>3</sup>	789.1112.	packaging empaque
22200/305	60	6,04	0,023	00514.3	3
905	20	7,31	0,021	07177.3	12



### Table fork / Tenedor de mesa

22202/300	60	7,10	0,027	00516.7	3
900	20	8,99	0,023	07179.7	12



### Table spoon / Cuchara de mesa

22203/300	60	8,01	0,038	00517.4	3
900	20	9,90	0,029	07181.0	12



### Tea spoon / Cuchara té

22207/300	60	5,30	0,025	00521.1	3
900	20	6,25	0,017	22766.8	12



### 3 pcs. Flatware set / Juego cubiertos 3 pzas.

22299/001	60	7,17	0,031	01146.5	3
-----------	----	------	-------	---------	---

#### CONTENTS / CONTENIDO

1 - 22200/005 - 5" Steak knife / Cuchillo asado 5"

1 - 22202/000 - Table fork / Tenedor mesa

1 - 22203/000 - Table Spoon / Cuchara mesa



### 24 pcs. Flatware set / Juego Cubiertos 24 pzas.

22299/050	10	8,78	0,035	11233.9	3
-----------	----	------	-------	---------	---

#### CONTENTS / CONTENIDO

6 - 22200/005 - 5" Steak knives / Cuchillos asado 5"

6 - 22202/000 - Table forks / Tenedores mesa

6 - 22203/000 - Table spoons / Cucharas mesa

6 - 22207/000 - Tea spoons / Cucharas té



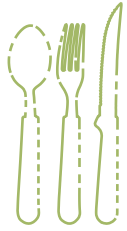

# FLAT WARE

# CU BIERTOS

## Dynamic

- stainless steel blades | láminas de acero inoxidable
- jatobá wooden handles | mangos de madera natural jatobá
- aluminum rivets | remaches de aluminio



### (5") Steak knife / Cuchillo para asado

Ref.	un.	Kg	m <sup>3</sup>	789.1112.	packaging empaque
22300/305	60	5,98	0,023	01864.8	3
405	600	16,39	0,031	03536.2	1111
905	20	7,31	0,021	07186.5	12



### (5") Steak knife / Cuchillo para asado

22321/105	60	3,10	0,020	07385.2	1
905	20	7,51	0,021	15606.7	12



### Table fork / Tenedor de mesa

22302/300	60	7,33	0,031	01720.7	3
400	600	21,02	0,042	03538.6	1111
900	20	8,79	0,023	07188.9	12



### Table spoon / Cuchara de mesa

22303/300	60	8,01	0,038	01721.4	3
400	600	22,54	0,043	03539.3	1111
900	20	10,10	0,029	07190.2	12



### Tea spoon / Cuchara té

22307/300	60	5,30	0,026	01725.2	3
400	600	13,85	0,034	03543.0	1111
900	20	6,04	0,017	22768.2	12



### 3 pcs. Flatware set / Juego cubiertos 3 pzas.

22399/001	60	7,07	0,032	01726.9	3
-----------	----	------	-------	---------	---

#### CONTENTS / CONTENIDO

- 1 - 22300/005 - 5" Steak knife / Cuchillo asado 5"
- 1 - 22302/000 - Table fork / Tenedor mesa
- 1 - 22303/000 - Table spoon / Cuchara mesa



### 16 pcs. Flatware set / Juego Cubiertos 16 pzas.

22399/003	10	5,62	0,028	02993.4	16
-----------	----	------	-------	---------	----

#### CONTENTS / CONTENIDO

- 4 - 22300/005 - 5" Steak knives / Cuchillos asado 5"
- 4 - 22302/000 - Table forks / Tenedores mesa
- 4 - 22303/000 - Table spoons / Cucharas mesa
- 4 - 22307/000 - Tea spoons / Cucharas té



# FLAT WARE

# CUBIERTOS

## Leme

- stainless steel blades | láminas de acero inoxidable
- polypropylene handles | mangos de polipropileno
- dishwasher safe | resistente a lavavajillas

### Colors | Colores



black | negro

grey | gris  
warm gray 3c

red | rojo  
187c

blue | azul  
7469c

### (4") Steak knife / Cuchillo para asado



Ref.	un.	Kg	m <sup>3</sup>	789.1112.	packaging empaque
■ 23180/304				17333.0	
■ 334	60	4,30	0,022	28174.5	3
■ 374				21142.1	
■ 394				28175.2	
■ 404				17306.4	
■ 434	600	11,50	0,033	28176.9	11
■ 474				18178.6	
■ 494				28177.6	
■ 904				22706.4	
■ 934	20	4,87	0,017	28178.3	12
■ 974				22710.1	
■ 994				28179.0	

### Table fork / Tenedor de mesa



■ 23182/300				17338.5	
■ 330	60	5,32	0,024	28182.0	3
■ 370				21143.8	
■ 390				28183.7	
■ 400				17311.8	
■ 430	600	14,50	0,043	28184.4	11
■ 470				18179.3	
■ 490				28185.1	
■ 900				22712.5	
■ 930	20	6,12	0,017	28186.8	12
■ 970				22716.3	
■ 990				28187.5	

### Table spoon / Cuchara de mesa



■ 23183/300				17323.1	
■ 330	60	6,61	0,037	28190.5	3
■ 370				21144.5	
■ 390				28191.2	
■ 400				17301.9	
■ 430	600	18,05	0,043	28192.9	11
■ 470				18180.9	
■ 490				28193.6	
■ 900				22718.7	
■ 930	20	7,63	0,023	28194.3	12
■ 970				22722.4	
■ 990				28195.0	

**Dessert fork / Tenedor postre**



Ref.	un.	Kg	m³	789.1112	packaging empaque
■ 23185/400				19157.0	
■ 430				28198.1	
■ 470	600	8,82	0,034	21146.9	
■ 490				28210.0	

**Dessert spoon / Cuchara postre**



■ 23186/400				19173.0	
■ 430				28199.8	
■ 470	600	11,39	0,034	21147.6	
■ 490				28211.7	

**Tea spoon / Cuchara té**



■ 23187/300				17328.6	
■ 330				28202.5	3
■ 370	60	3,16	0,023	21145.2	
■ 390				28203.2	
■ 400				17317.0	
■ 430				28204.9	
■ 470	600	7,62	0,026	20099.9	
■ 490				28205.6	



NEW | NUEVO



**12 pcs. Flatware set / Juego de cubiertos 12 pzas.**

Ref.	un.	Kg	m <sup>3</sup>	789.1112.	packaging empaque
■ 23198/039				18714.6	12
■ 339	10	2,95	0,015	28591.0	
■ 739				20026.5	
■ 939				28592.7	

CONTENTS / CONTENIDO

- 3 - 23180/074 - 4" Steak knives / Cuchillos para asado 4"
- 3 - 23182/070 - Table forks / Tenedores de mesa
- 3 - 23183/070 - Table spoons / Cucharas de mesa
- 3 - 23187/070 - Tea spoons / Cucharas para té

NEW | NUEVO



**20 pcs. Flatware set / Juego de cubiertos 20 pzas.**

■ 23198/018				29097.6	12
■ 318	06	2,91	0,016	29098.3	
■ 718				29099.0	
■ 918				29100.3	

CONTENTS / CONTENIDO

- 4 - 23180/074 - 4" Steak knives / Cuchillos para asado 4"
- 4 - 23182/070 - Table forks / Tenedores de mesa
- 4 - 23183/070 - Table spoons / Cucharas de mesa
- 4 - 23185/070 - Dessert forks / Tenedores postre
- 4 - 23187/070 - Tea spoons / Cucharas para té



**24 pcs. Flatware set / Juego Cubiertos 24 pzas.**

■ 23198/031				17795.6	12
■ 331	12	7,37	0,046	28206.3	
■ 731				18139.7	
■ 931				28207.0	

CONTENTS / CONTENIDO

- 6 - 23180/074 - 4" Steak knives / Cuchillos asado 4"
- 6 - 23182/070 - Table forks / Tenedores mesa
- 6 - 23183/070 - Table spoons / Cucharas mesa
- 6 - 23187/070 - Tea spoons / Cucharas té

NEW | NUEVO



**25 pcs. Flatware set / Juego de cubiertos 25 pzas.**

■ 23198/022				28558.3	12
■ 322	06	4,17	0,018	28559.0	
■ 722				28560.6	
■ 922				28561.3	

CONTENTS / CONTENIDO

- 6 - 23180/074 - 4" Steak knives / Cuchillos para asado 4"
- 6 - 23182/070 - Table forks / Tenedores mesa
- 6 - 23183/070 - Table spoons / Cucharas mesa
- 6 - 23187/070 - Tea spoons / Cucharas té
- 1 - 29900/478 - Flatware drawer / Organizador de cubiertos



# FLAT WARE

# CUBIERTOS

## New Kolor

- stainless steel blades | láminas de acero inoxidable
- polypropylene handles | mangos de polipropileno
- dishwasher safe | resistente a lavavajillas

### Colors | Colores



black | negro



blue | azul  
282c



beige | crema  
1205c



red | rojo  
187c



white | blanco

### (4") Steak knife / Cuchillo para asado



Ref.	un.	Kg	m <sup>3</sup>	789.1112.	packaging empaque
■ 23160/304				06645.8	
■ 314	60	4,23	0,023	05648.0	3
■ 374				09457.4	
■ 404				05650.3	
■ 414	600	11,30	0,031	05651.0	111
■ 474				08517.6	
■ 904				22730.9	
■ 914				07192.6	
■ 934	20	4,87	0,017	07193.3	12
■ 974				22733.0	
□ 984				22734.7	

### Table fork / Tenedor de mesa



■ 23162/300				06647.2	
■ 310	60	5,19	0,026	05666.4	3
■ 370				09460.4	
■ 400				05668.8	
■ 410	600	14,30	0,043	05669.5	111
■ 470				08520.6	
■ 900				22751.4	
■ 910				07194.0	
■ 930	20	6,12	0,017	07195.7	12
■ 970				22754.5	
□ 980				22755.2	

### Table spoon / Cuchara de mesa



■ 23163/300				06648.9	
■ 310	60	6,57	0,036	05676.3	3
■ 370				09463.5	
■ 400				05678.7	
■ 410	600	17,80	0,043	05679.4	111
■ 470				08523.7	
■ 900				22735.4	
■ 910				07196.4	
■ 930	20	7,63	0,023	07197.1	12
■ 970				22738.5	
□ 980				22739.2	



**Tea spoon / Cuchara té**

Ref.	un.	Kg	m <sup>3</sup>	789.1112.	packaging empaque
■ 23167/300				06652.6	3
■ 310	60	3,45	0,023	05713.5	
■ 370				19413.7	
■ 400				05715.9	1111
■ 410	600	7,54	0,026	05716.6	
■ 470				19414.4	
■ 900				22740.8	12
■ 910				22741.5	
■ 930	20	3,36	0,012	22743.9	
■ 970				22745.3	
□ 980				22746.0	



**3 pcs. Flatware set / Juego de cubiertos 3 pzas.**

■ 23199/069				11310.7	3
■ 169	60	5,53	0,034	06640.3	
■ 769				19369.7	

**CONTENTS / CONTENIDO**

- 1 - 23160/004 - 4" Steak knife / Cuchillo asado 4"
- 1 - 23162/000 - Table fork / Tenedor mesa
- 1 - 23163/000 - Table spoon / Cuchara mesa



**24 pcs. Flatware set / Juego de cubiertos 24 pzas.**

■ 23199/062				06897.1	1
■ 162				05721.0	
■ 362	10	6,73	0,035	05723.4	
■ 762				08866.5	
□ 862				13647.2	

**CONTENTS / CONTENIDO**

- 6 - 23160/004 - 4" Steak knives / Cuchillos para asado 4"
- 6 - 23162/000 - Table forks / Tenedores mesa
- 6 - 23163/000 - Table spoons / Cucharas mesa
- 6 - 23167/000 - Tea spoons / Cucharas té



**25 pcs. Flatware set / Juego de cubiertos 25 pzas.**

■ 23198/075				19445.8	1
■ 175	10	6,63	0,046	19446.5	
■ 775				19450.2	

**CONTENTS / CONTENIDO**

- 6 - 23160/004 - 4" Steak knives / Cuchillos para asado 4"
- 6 - 23162/000 - Table forks / Tenedores mesa
- 6 - 23163/000 - Table spoons / Cucharas mesa
- 6 - 23167/000 - Tea spoons / Cucharas té
- 1 - 29900/474 - Flatware drawer / Organizador de cubiertos



# FLAT WARE

# CUBIERTOS

## Ipanema

- stainless steel blades | láminas de acero inoxidable
- polypropylene handles | mangos de polipropileno
- dishwasher safe | resistente a lavavajillas

### Colors | Colores



red | rojo 187c    black | negro    blue | azul 282c    green | verde 328c    guava | guayaba 7607c    grey | gris warm gray 3c    red | rojo 1797c    white | blanco    mint green | verde menta 5503c    pink | rosa 1775c

### (5") Steak knife / Cuchillo para asado



Ref.	un.	Kg	m <sup>3</sup>	789.1112.	packaging empaque
■ 23360/305				04426.5	
■ 315				04564.4	
■ 322				28215.5	
■ 344	60	5,46	0,024	28216.2	3
■ 366				28217.9	
■ 375				07958.8	
□ 385				04569.9	
■ 405				04509.5	
■ 415				04232.2	
■ 422				28218.6	
■ 444	600	15,44	0,047	28219.3	III
■ 466				28220.9	
■ 475				08388.2	
□ 485				04513.2	
■ 905				07198.8	
■ 915	20	6,77	0,023	07199.5	12
■ 975				22666.1	
□ 985				22667.8	

### Table fork / Tenedor de mesa



■ 23362/300				04429.6	
■ 310				04577.4	
■ 322				28227.8	
■ 344	60	5,91	0,032	28228.5	3
■ 366				28229.2	
■ 370				07959.5	
□ 380				04582.8	
■ 400				04519.4	
■ 410				04246.9	
■ 422				28230.8	
■ 444	600	16,35	0,047	28231.5	III
■ 466				28232.2	
■ 470				08390.5	
□ 480				04523.1	
■ 900				07201.5	
■ 910	20	6,91	0,021	07202.2	12
■ 970				22672.2	
□ 980				22673.9	

**Table spoon / Cuchara de mesa**



Ref.	un.	Kg	m <sup>3</sup>	789.1112.	packaging empaque
■ 23363/300				04431.9	
■ 310				04583.5	
■ 322				28239.1	
■ 344	60	6,63	0,038	28240.7	3
■ 366				28244.5	
■ 370				07960.1	
□ 380				04588.0	
■ 400				04524.8	
■ 410				04253.7	
■ 422				28242.1	
■ 444	600	18,35	0,041	28243.8	
■ 466				28241.4	
■ 470				08391.2	
□ 480				04528.6	
■ 900				07204.6	
■ 910	20	7,74	0,026	07205.3	12
■ 970				22678.4	
□ 980				22679.1	

**Dessert fork / Tenedor de postre**



■ 23365/400				04534.7	
■ 410				04267.4	
■ 422				28261.2	
■ 444	600	10,62	0,035	28262.9	
■ 466				28263.6	
■ 470				08394.3	
□ 480				04538.5	

**Dessert spoon / Cuchara postre**



■ 23366/400				04539.2	
■ 410				04274.2	
■ 422				28267.4	
■ 444	600	13,34	0,036	28268.1	
■ 466				28269.8	
■ 470				08395.0	
□ 480				04543.9	

**Tea spoon / Cuchara té**



■ 23367/300				04436.4	
■ 310				04610.8	
■ 322				28249.0	
■ 344	60	3,82	0,024	28250.6	3
■ 366				28251.3	
■ 370				08406.3	
□ 380				04615.3	
■ 400				04544.6	
■ 410				04282.7	
■ 422				28252.0	
■ 444	600	9,50	0,027	28253.7	
■ 466				28254.4	
■ 470				08396.7	
□ 480				04548.4	
■ 900				22681.4	
■ 910	20	4,16	0,014	22682.1	12
■ 970				22687.6	
□ 980				22688.3	

**(2") Butter spreader / Espátula mantequilla**



■ 23375/002				08707.1	
■ 012				08073.7	
■ 522				28270.4	
■ 542	600	9,38	0,024	28271.1	
■ 562				28272.8	
■ 072				08711.8	
□ 082				08075.1	



**6 pcs. Butter spreader set /  
Juego espátulas mantequilla 6 pzas.**

Ref.	un.	Kg	m³	789.1112.	packaging empaque
■ 23399/048				09121.4	
■ 148				08085.0	
■ 748				09125.2	
□ 848	20	2,17	0,009	08094.2	6
■ 23398/248				28276.6	
■ 448				28277.3	
■ 648				28278.0	

CONTENTS / CONTENIDO  
6 - 23375/522



**6 pcs. Appetizer forks set /  
Juego tenedores para bocadillos 6 pzas.**

23399/410	60	4,22	0,021	28279.7	6
-----------	----	------	-------	---------	---

CONTENTS / CONTENIDO  
 ■ 1 - 23376/010  
 ■ 1 - 23376/520  
 ■ 1 - 23376/540  
 ■ 1 - 23376/560  
 ■ 1 - 23376/070  
 □ 1 - 23376/080



**24 pcs. Flatware set / Juego cubiertos 24 pzas.**

■ 23398/072				20369.3	
■ 172				20399.0	
■ 272				28280.3	
■ 472	10	7,20	0,036	28281.0	6
■ 672				28282.7	
■ 772				20400.3	
□ 872				21195.7	

CONTENTS / CONTENIDO  
 6 - 23360/525 - 5" Steak knives / Cuchillos asado 5"  
 6 - 23362/520 - Table forks / Tenedores mesa  
 6 - 23363/520 - Table spoons / Cucharas mesa  
 6 - 23367/520 - Tea spoons / Cucharas té



**24 pcs. Flatware set / Juego cubiertos 24 pzas.**

■ 23399/091				11227.8	
■ 191				08622.7	
■ 791				08635.7	
□ 891	12	8,45	0,048	08638.8	6
■ 23398/291				28283.4	
■ 491				28284.1	
■ 691				28285.8	

CONTENTS / CONTENIDO  
 6 - 23360/525 - 5" Steak knives / Cuchillos asado 5"  
 6 - 23362/520 - Table forks / Tenedores mesa  
 6 - 23363/520 - Table spoons / Cucharas mesa  
 6 - 23367/520 - Tea spoons / Cucharas té

NEW | NUEVO



**30 pcs. Flatware set / Juego de cubiertos 30 pzas.**

■ 23398/088				27408.2	
■ 288				27409.9	
■ 488				27410.5	
■ 788	06	4,62	0,022	27411.2	6

CONTENTS / CONTENIDO  
 6 - 23360/825 - 5" Steak knives / Cuchillos para asado 5"  
 6 - 23362/820 - Table forks / Tenedores de mesa  
 6 - 23363/820 - Table spoons / Cucharas de mesa  
 6 - 23365/820 - Dessert forks / Tenedores postre  
 6 - 23367/820 - Tea spoons / Cucharas té



# FLAT WARE

# CUBIERTOS

## Tulum

- stainless steel blades | láminas de acero inoxidable
- polypropylene handles | mangos de polipropileno
- dishwasher safe | resistente a lavavajillas

### Colors | Colores



blue | azul  
2728c



azul | turquoise  
7709c



onyx | onix  
432c



red | rojo  
187c



off-white  
cool gray 1c

### (5") Steak knife / Cuchillo para asado



Ref.	un.	Kg	m <sup>3</sup>	789.1112.	packaging empaque
■ 23270/411				28344.2	
■ 415				20867.4	
■ 465	240	5,72	0,012	20869.8	
■ 477				28345.9	
□ 485				20871.1	

### Table fork / Tenedor de mesa



■ 23272/411				28346.6	
■ 410				20872.8	
■ 460	240	6,63	0,019	20874.2	
■ 477				28347.3	
□ 480				20876.6	

### Table spoon / Cuchara de mesa



■ 23273/411				28348.0	
■ 410				20877.3	
■ 460	240	7,32	0,019	20879.7	
■ 477				28349.7	
□ 480				20881.0	

### Dessert/tea spoon / Cuchara postre/té



■ 23276/411				28350.3	
■ 410				20887.2	
■ 460	240	5,35	0,013	20889.6	
■ 477				28351.0	
□ 480				20891.9	





**25 pcs. Flatware set / Juego de cubiertos 25 pzas.**

Ref.	un.	Kg	m <sup>3</sup>	789.1112.	packaging empaque
■ 23299/183				25873.0	
■ 383				28353.4	
■ 683	06	4,38	0,019	25858.7	■
■ 783				25859.4	
□ 883				25860.0	

**CONTENTS / CONTENIDO**

- 6 - 23270/715 - 5" Steak knives / Cuchillos asado 5"
- 6 - 23272/710 - Table forks / Tenedores mesa
- 6 - 23273/710 - Table spoons / Cucharas mesa
- 6 - 23276/511 - Dessert/tea spoons / Cucharas postre/té
- 1 - 29900/474 - Flatware drawer / Organizador de cubiertos





# FLAT WARE

# CUBIERTOS

## Plenus

- stainless steel blades | láminas de acero inoxidable
- polypropylene handles | mangos de polipropileno
- dishwasher safe | resistente a lavavajillas

### Colors | Colores



black | negro



blue | azul  
2154c



off-white  
cool gray 1c



grey | gris  
cool gray 11c



red | rojo  
200c

### (5") Steak knife / Cuchillo para asado



Ref.	un.	Kg	m <sup>3</sup>	789.1112.	packaging empaque
■ 23410/405				22468.1	
■ 415				22469.8	
□ 435	240	7,43	0,019	22470.4	
■ 465				22471.1	
■ 475				22472.8	

### Table fork / Tenedor de mesa



■ 23412/400				22473.5	
■ 410				22474.2	
□ 430	240	7,31	0,019	22475.9	
■ 460				22476.6	
■ 470				22477.3	

### Table spoon / Cuchara de mesa



■ 23413/400				22478.0	
■ 410				22479.7	
□ 430	240	7,79	0,019	22480.3	
■ 460				22481.0	
■ 470				22482.7	

### Tea spoon / Cuchara té



■ 23417/400				22483.4	
■ 410				22484.1	
□ 430	240	4,48	0,013	22485.8	
■ 460				22486.5	
■ 470				22487.2	



**16 pcs. Flatware set / Juego de cubiertos 16 pzas.**

Ref.	un.	Kg	m <sup>3</sup>	789.1112.	packaging empaque
■ 23498/001				22912.9	
■ 101				22913.6	
□ 301	10	4,87	0,022	22914.3	16
■ 601				22915.0	
■ 701				22916.7	

**CONTENTS / CONTENIDO**

- 4 - 23410/065 - 5" Steak knives / Cuchillos asado 5"
- 4 - 23412/060 - Table forks / Tenedores mesa
- 4 - 23413/060 - Table spoons / Cucharas de mesa
- 4 - 23417/060 - Tea spoons / Cucharas té



**25 pcs. Flatware set / Juego de cubiertos 25 pzas.**

■ 23498/030				25282.0	
■ 130				25283.7	
□ 330	10	8,77	0,049	25284.4	—
■ 630				25285.1	
■ 730				28623.8	

**CONTENTS / CONTENIDO**

- 6 - 23410/065 - 5" Steak knives / Cuchillos asado 5"
- 6 - 23412/060 - Table forks / Tenedores mesa
- 6 - 23413/060 - Table spoons / Cucharas de mesa
- 6 - 23417/060 - Tea spoons / Cucharas té
- 1 - 29900/478 - Flatware drawer / Organizador de cubiertos





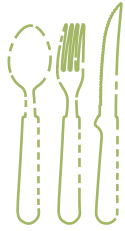

# FLAT WARE

# CU BIER TOS

## Bliss

- stainless steel blades | láminas de acero inoxidable
- polypropylene handles with patterns | mangos de polipropileno estampado

### Colors | Colores



blue gray | azul grisáceo  
2157c



crimson | carmín  
188c



light gray | gris mediano  
cool gray 6c



pinnk | rosa pastel  
7605c

NEW | NUEVO



#### 16 pcs. Flatware set / Juego de cubiertos 16 pzas.

Ref.	un.	Kg	m <sup>3</sup>	789.1112.	packaging empaques
29899/126	04	2,73	0,014	30061.3	

#### CONTENTS / CONTENIDO

- 4 - 29808/112 - 4" Steak knives / Cuchillos asado 4"
- 4 - 29808/113 - Table forks / Tenedores de mesa
- 4 - 29808/114 - Table spoons / Cucharas de mesa
- 4 - 29808/115 - Tea spoons / Cucharas de té

NEW | NUEVO



#### 16 pcs. Flatware set / Juego de cubiertos 16 pzas.

29899/127	04	2,73	0,014	30062.0	
-----------	----	------	-------	---------	--

#### CONTENTS / CONTENIDO

- 4 - 29808/116 - 4" Steak knives / Cuchillos asado 4"
- 4 - 29808/117 - Table forks / Tenedores de mesa
- 4 - 29808/118 - Table spoons / Cucharas de mesa
- 4 - 29808/119 - Tea spoons / Cucharas de té

NEW | NUEVO



#### 16 pcs. Flatware set / Juego de cubiertos 16 pzas.

29899/128	04	2,73	0,014	30063.7	
-----------	----	------	-------	---------	--

#### CONTENTS / CONTENIDO

- 4 - 29808/120 - 4" Steak knives / Cuchillos asado 4"
- 4 - 29808/121 - Table forks / Tenedores de mesa
- 4 - 29808/122 - Table spoons / Cucharas de mesa
- 4 - 29808/123 - Tea spoons / Cucharas de té

NEW | NUEVO



#### 16 pcs. Flatware set / Juego de cubiertos 16 pzas.

29899/129	04	2,73	0,014	30064.4	
-----------	----	------	-------	---------	--

#### CONTENTS / CONTENIDO

- 4 - 29808/124 - 4" Steak knives / Cuchillos asado 4"
- 4 - 29808/125 - Table forks / Tenedores de mesa
- 4 - 29808/126 - Table spoons / Cucharas de mesa
- 4 - 29808/127 - Tea spoons / Cucharas de té



# FLAT WARE

# CUBIERTOS

## Carmel

- stainless steel blades | láminas de acero inoxidable
- polypropylene handles | mangos de polipropileno
- dishwasher safe | resistente a lavavajillas

### Colors | Colores

dark tan   natural oscuro 432c	medium tan   natural médio warm gray 3c	light tan   natural claro cool gray 1c	dark turquoise   turquesa oscuro 7469c	medium turquoise   turquesa médio 7466c	light turquoise   turquesa claro 5503c	dark magenta   carmín oscuro 188c	medium magenta   carmín médio 1805c	light magenta   carmín claro 7605c	dark purple   púrpura oscuro 520c	medium purple   púrpura médio 7425c	light purple   púrpura claro 523c

### 24 pcs. Flatware set / Juego de cubiertos 24 pzas.



Ref.	un.	Kg	m <sup>3</sup>	789.1112.	packaging empaque
■ 23499/021				17677.5	
■ 022				17678.2	
■ 023				17679.9	
■ 024				17680.5	
■ 025				17681.2	
■ 026	06	5,02	0,036	17682.9	
■ 027				17683.6	
■ 028				17684.3	
■ 029				17685.0	
■ 030				17686.7	
■ 031				17687.4	
■ 032				17688.1	

#### CONTENTS / CONTENIDO

- 6 - 23400/004 - 4" Steak knives / Cuchillos asado 4"
- 6 - 23402/004 - Table forks / Tenedores mesa
- 6 - 23403/004 - Table spoons / Cucharas de mesa
- 6 - 23407/004 - Tea spoons / Cucharas té

### NEW | NUEVO



### 25 pcs. Flatware set / Juego de cubiertos 25 pzas.

■ 23499/043				27538.6	
■ 044				27539.3	
■ 045	06	4,95	0,018	27540.9	
■ 046				27541.6	

#### CONTENTS / CONTENIDO

- 6 - 23401/001 - 4" Table knives / Cuchillos de mesa 4"
- 6 - 23402/001 - Table forks / Tenedores de mesa
- 6 - 23403/001 - Table spoons / Cucharas de mesa
- 6 - 23407/001 - Tea spoons / Cucharas de té
- 1 - 29900/474 - Flatware drawer / Separador de cubiertos







## FLAT WARE

## CU BIER TOS

## Pizza

- stainless steel blades | láminas de acero inoxidable
- polypropylene handles | mangos de polipropileno
- dishwasher safe | resistente a lavavajillas

### Colors | Colores



black | negro



red | rojo  
1805c



### 14 pcs. Pizza set / Juego para pizza 14 pzas.

Ref.	un.	Kg	m <sup>3</sup>	789.1112.	packaging empaque
■ 25099/022	05	4,88	0,054	16067.5	■
■ 722				16069.9	

#### CONTENTS / CONTENIDO

- 6 - 25040/004 - 4" Pizza knives / Cuchillos pizza 4"
- 6 - 25042/000 - Pizza forks / Tenedores pizza
- 1 - 25048/000 - Pizza spatula / Espátula pizza
- 1 - 25049/000 - Pizza cutter / Cortador pizza



# FLAT WARE

# CUBIERTOS

## Malibu

- stainless steel tableware | cubiertos de acero inoxidable
- dishwasher safe | resistente a lavavajillas



NEW | NUEVO

### (4") Steak knife / Cuchillo para asado

Ref.	un.	Kg	m <sup>3</sup>	789.1112.	packaging empaque
23730/004	300	13,44	0,005	09603.5	
304	30	3,51	0,005	27228.6	3



### (4") Table knife / Cuchillo de mesa

23731/004	300	10,23	0,005	06848.3	
-----------	-----	-------	-------	---------	--



NEW | NUEVO

### Table fork / Tenedor de mesa

23742/000	600	13,28	0,012	19987.3	
300	30	2,42	0,012	27229.3	3



NEW | NUEVO

### Table spoon / Cuchara de mesa

23743/000	600	19,50	0,017	19988.0	
300	30	3,47	0,012	27230.9	3



### (3") Dessert knife / Cuchillo postre

23734/003	300	7,74	0,004	08578.7	
-----------	-----	------	-------	---------	--



### Dessert fork / Tenedor postre

23735/000	600	8,88	0,007	07738.6	
-----------	-----	------	-------	---------	--



### Dessert spoon / Cuchara postre

23736/000	600	11,90	0,013	06851.3	
-----------	-----	-------	-------	---------	--



NEW | NUEVO

### Tea spoon / Cuchara té

23737/000	600	8,51	0,008	07053.0	
300	30	1,79	0,009	07054.7	3

**Coffee spoon / Cuchara café**

Ref.	un.	Kg	m³	789.1112.	packaging empaque
23738/000	600	3,41	0,004	19989.7	



**Round spoon / Cuchara redonda**

23739/000	600	13,94	0,022	06852.0	
-----------	-----	-------	-------	---------	---



**Ice tea spoon / Cuchara refresco**

23740/000	300	8,24	0,009	06898.8	
-----------	-----	------	-------	---------	---



**Cake fork / Tenedor pastel**

23741/000	600	9,73	0,010	07594.8	
-----------	-----	------	-------	---------	---



**24 pcs. Flatware set / Juego de cubiertos 24 pzas.**

23798/046	10	7,50	0,027	27407.5	
-----------	----	------	-------	---------	---

**CONTENTS / CONTENIDO**

- 6 - 23730/004 - 4" Steak knives / Cuchillos asado 4"
- 6 - 23742/000 - Table forks / Tenedores mesa
- 6 - 23743/000 - Table spoons / Cucharas mesa
- 6 - 23737/000 - Tea spoons / Cucharas té



**42 pcs. Flatware set / Juego de cubiertos 42 pzas.**

23799/039	05	6,67	0,045	10015.2	
-----------	----	------	-------	---------	---

**CONTENTS / CONTENIDO**

- 6 - 23730/004 - 4" Steak knives / Cuchillos asado 4"
- 6 - 23742/000 - Table forks / Tenedores mesa
- 6 - 23743/000 - Table spoons / Cucharas mesa
- 6 - 23735/000 - Dessert forks / Tenedores postre
- 6 - 23736/000 - Dessert spoons / Cucharas postre
- 6 - 23737/000 - Tea spoons / Cucharas té
- 6 - 23741/000 - Cake forks / Tenedores pastel

**NEW | NUEVO**



**85 pcs. Flatware set / Juego de cubiertos 85 pzas.**

23798/042	05	12,07	0,037	22763.7	
-----------	----	-------	-------	---------	---

**CONTENTS / CONTENIDO**

- 12 - 23730/004 - 4" Steak knives / Cuchillos para asado 4"
- 12 - 23742/000 - Table forks / Tenedores de mesa
- 12 - 23743/000 - Table spoons / Cucharas de mesa
- 12 - 23735/000 - Dessert forks / Tenedores postre
- 12 - 23736/000 - Dessert spoons / Cucharas postre
- 12 - 23737/000 - Tea spoons / Cucharas para té
- 1 - 23740/000 - Ice tea spoon / Cuchara refresco
- 12 - 23741/000 - Cake forks / Tenedores pastel



# FLAT WARE

# CU BIER TOS

## Búzios

- stainless steel tableware | cubiertos de acero inoxidable
- dishwasher safe | resistente a lavavajillas



### (4") Steak knife / Cuchillo para asado

Ref.	un.	Kg	m <sup>3</sup>	789.1112.	packaging empaque
23750/004	300	10,22	0,004	08871.9	
404	300	10,37	0,005	12283.3	



### (4") Table knife / Cuchillo de mesa

23751/004	300	10,49	0,005	08872.6	
404	300	10,37	0,005	12284.0	



### Table fork / Tenedor de mesa

23762/000	600	13,05	0,011	19992.7	
400	600	13,03	0,008	21071.4	



### Table spoon / Cuchara de mesa

23763/000	600	19,44	0,014	19993.4	
400	600	19,14	0,011	21073.8	



### (3") Dessert knife / Cuchillo postre

23754/003	300	8,36	0,005	19990.3	
403	300	7,73	0,004	21132.2	



### Dessert fork / Tenedor postre

23755/000	600	8,92	0,008	10000.8	
400	600	8,85	0,005	12287.1	



### Dessert spoon / Cuchara postre

23756/000	600	13,32	0,010	09007.1	
400	600	13,27	0,008	12288.8	



### Tea spoon / Cuchara té

Ref.	un.	Kg	m <sup>3</sup>	789.1112.	packaging empaque
23757/000	600	8,46	0,008	08873.3	
400	600	8,37	0,005	12289.5	



### Coffee spoon / Cuchara café

23758/000	600	3,47	0,003	08874.0	
400	600	3,40	0,003	12290.1	



### Cake fork / Tenedor pastel

23761/000	600	9,44	0,010	19991.0	
400	600	9,36	0,008	21134.6	



### 24 pcs. Flatware set / Juego de cubiertos 24 pzas.

23799/071	05	4,13	0,024	18594.4	
-----------	----	------	-------	---------	--

#### CONTENTS / CONTENIDO

- 6 - 23750/004 - 4" Steak knives / Cuchillos asado 4"
- 6 - 23762/000 - Table forks / Tenedores mesa
- 6 - 23763/000 - Table spoons / Cucharas mesa
- 6 - 23757/000 - Tea spoons / Cucharas té

NEW | NUEVO



### 30 pcs. Flatware set / Juego de cubiertos 30 pzas.

23798/050	05	4,79	0,026	21664.8	
-----------	----	------	-------	---------	--

#### CONTENTS / CONTENIDO

- 6 - 23750/004 - 4" Steak knives / Cuchillos para asado 4"
- 6 - 23762/000 - Table forks / Tenedores de mesa
- 6 - 23763/000 - Table spoons / Cucharas de mesa
- 6 - 23761/000 - Cake forks / Tenedores pastel
- 6 - 23757/000 - Tea spoons / Cucharas para té



### 54 pcs. Flatware set / Juego de cubiertos 54 pzas.

23799/077	05	7,80	0,043	20764.6	
-----------	----	------	-------	---------	--

#### CONTENTS / CONTENIDO

- 6 - 23750/004 - 4" Steak knives / Cuchillos asado 4"
- 6 - 23762/000 - Table forks / Tenedores mesa
- 6 - 23763/000 - Table spoons / Cucharas mesa
- 6 - 23754/003 - 3" Dessert knives / Cuchillos postre 3"
- 6 - 23755/000 - Dessert forks / Tenedores postre
- 6 - 23756/000 - Dessert spoons / Cucharas postre
- 6 - 23757/000 - Tea spoons / Cucharas té
- 6 - 23758/000 - Coffee spoons / Cucharas café
- 6 - 23761/000 - Cake forks / Tenedores pastel



# KNIVES

# CUCHILLOS

**YOUR RECIPIES WILL NOT BE THE ONLY THING THAT WILL EARN COMPLIMENTS. | SUS RECETAS NO SERÁN LAS ÚNICAS QUE RECIBIRÁN ELOGIOS.**

- 76. *Polywood*
- 79. *Verttice*
- 80. *Tradicional*
- 83. *Dynamic*
- 86. *Carbon*
- 87. *Colorcut*
- 88. *Plenus*
- 95. *Affilata*
- 97. *Multicolor*
- 99. *Ultracorte*
- 102. *Premium*
- 104. *Nygma*
- 108. *Century*
- 114. *Sushi*
- 118. *Cronos*
- 122. *Professional Knives |  
Cuchillos Profesionales*
- 133. *Profio*
- 134. *Pocket Knives | Navajas*
- 135. *Sports Knives |  
Cuchillos Deportivos*

From breakfast to dinner, from grilled cheese to tartar, those who cook know: using the right knife makes all the difference. With a design that values comfort in handling and safety, Tramontina Knives are an extension in the kitchen of home chefs and professional chefs. There are different models and specific uses, but if you need to improvise, that is fine. After all, there is no rule to do it right when preparing meals.

Desde el desayuno hasta la cena, desde el sándwich hasta el tartar, quien cocina lo sabe: usar el cuchillo correcta marca toda la diferencia. Con un diseño que cuida el confort en el uso y la seguridad, los Cuchillos Tramontina son una extensión en la cocina de los chefs caseros y de los chefs profesionales. Hay diferentes modelos y usos específicos, pero está todo bien si necesita improvisar. Porque no hay reglas para hacerlo a su manera al preparar las comidas.

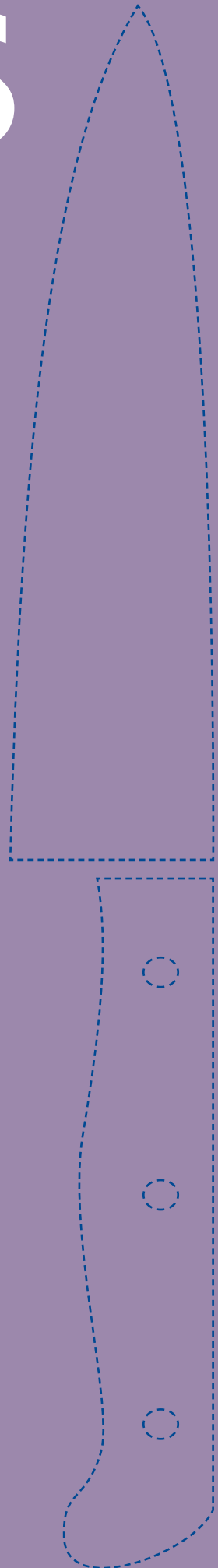





# KNIVES CUCHILLOS

## fruit knife | cuchillo para frutas



Ideal for cutting and peeling various fruits.

Ideal para cortar y pelar frutas diversas.

## tomato knife | cuchillo para tomate

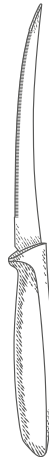

watch the video

The microerrated blade cuts through the tomato skin without squishing it.



vea el video

Con lámina microdentada que rompe la piel del tomate sin aplastarlo.

## vegetable and fruit knife | cuchillo para legumbres y frutas



watch the video

Ideal for cutting, peeling, and delicate slicing.



vea el video

Ideal para cortar, pelar y hacer cortes delicados.

## vegetable and fruit knife | cuchillo para legumbres y frutas



For cutting, peeling and decorating medium-sized fruits and vegetables.

Para cortar, pelar y decorar legumbres, vegetales y frutas de tamaño mediano.

## vegetable and fruit knife | cuchillo para legumbres y frutas



Ideal for peeling, decorating and cleaning food.

Ideal para pelar, decorar y hacer la limpieza de los alimentos.

## peeling knife | cuchillo para tornear



watch the video

For paring, peeling, and sculpting fruits and vegetables.



vea el video

Tornea, pela y esculpe frutas y legumbres.

## boning knife | cuchillo para deshuesar



watch the video

Ideal for separating meat from bones and removing fat.



vea el video

Ideal para separar la carne de los huesos y sacarle la grasa.



### fillet knife | cuchillo para filetear



watch the video

With its flexible blade, this knife is recommended for filleting and skinning fish.



vea el vídeo

Con lámina flexible, indicado para cortes de filetes y para retirar la piel de pescados.



### bread knife | cuchillo para pan



watch the video

The serrated blade slices without squishing.



vea el vídeo

La lámina dentada corta sin aplastar el pan.

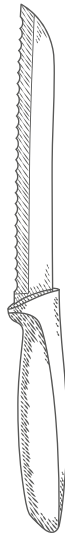

### pastry knife | cuchillo para confitería



With its long, serrated blade, this knife is ideal for cutting cakes and pies.

Con lámina larga y con dientes, es ideal para el corte y la preparación de tortas y tartas.



### cleaver | hachuela



watch the video

Ideal for breaking and separating bones.



vea el vídeo

Ideal para partir y separar huesos.

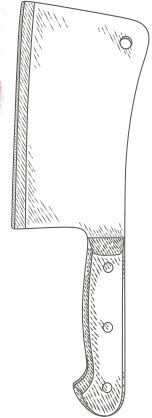

### cold cuts knife | cuchillo para fiambres



watch the video

Recommended for cutting thin slices of cold cuts.



vea el vídeo

Indicado para cortes de rebanadas finas de fiambre.

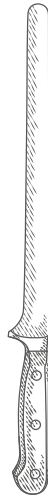

### cheese knife | cuchillo para queso



watch the video

Ideal for cutting and slicing soft and semi hard-cheeses.



vea el vídeo

Ideal para cortar y rebanar quesos blandos y semiduros.

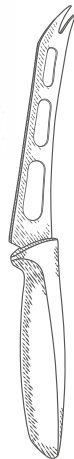

### steak/fruit knife | cuchillo para asado/frutas



With its serrated edge, this knife is ideal for cutting cooked meats and fruit.

Con filo dentado es ideal para el corte de carnes asadas y frutas.

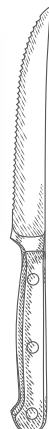

**kitchen knife |  
cuchillo de  
cocina**



watch the video



vea el video

The hard and narrow blade facilitates cutting various kinds of foods.

Con lámina rígida y estrecha, facilita el corte de diversos alimentos.



**sandwich knife |  
cuchillo para  
sándwiches**



With its serrated blade, this knife is ideal for slicing bread for sandwiches.

Con lámina dentada, es ideal para el corte del pan en la preparación de sándwiches.



**utility knife |  
cuchillo  
utility**



With its sword-like tip, this knife helps with opening and piercing the food.

Con punta en forma de espada, ayuda a abrir y perforar alimentos.

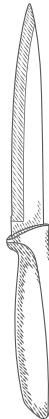

**chef's knife |  
cuchillo  
chef**



watch the video



vea el video

All the versatility of the main utensil in the kitchen.

Toda la versatilidad del protagonista de la cocina.



**butcher's knife |  
cuchillo para  
carne**



With its rigid blade and curved tip, this knife is ideal for cutting raw or cooked meats.

Con lámina rígida y punta curvada, es ideal para cortar carnes crudas, asadas o cocidas.

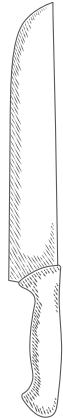

**cook's knife |  
cuchillo cocina**



Traditionally used for cutting fish, this knife has varied uses in the kitchen.

Cuchillo para usos diversos.



**carving knife |  
cuchillo  
trinchante**



With its long blade, slightly curved at the tip, this knife is ideal for carving roasted meat and poultry.

Con lámina larga, ligeramente curvada en la punta, es ideal para trincar carnes y aves asadas.

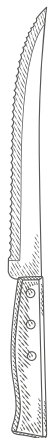



**oyster knife |  
cuchillo para  
ostras**



Flexible, easy to use and safe for opening oysters.

Agilidad, facilidad y seguridad para abrir ostras.

**mezzaluna  
knife |  
mezzaluna**

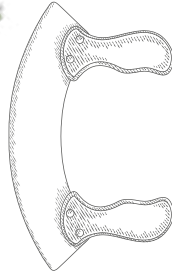

The curved blade makes it easy to chop herbs and spices.

La lámina curva facilita el corte de hierbas y condimentos.

**santoku knife |  
cuchillo  
santoku**



watch the video

Ideal for slicing, dicing, and chopping.



vea el video

Ideal para cortar, rebanar y picar.

**deba knife |  
cuchillo  
deba**

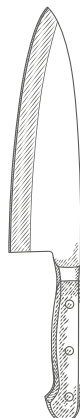

A strong blade for heavy cuts, widely used in cleaning and preparing fish.

Lámina robusta, indicada para cortes pesados, siendo muy utilizada en la limpieza y preparación de pescados.

**nakiri knife |  
cuchillo  
nakiri**

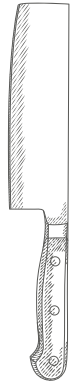

A wider blade for quick and uniform cutting of vegetables.

Lámina más ancha que proporciona un corte rápido e uniforme en legumbres y vegetales.

**yanagiba knife |  
cuchillo  
yanagiba**

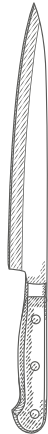

Classic style used in Asian cuisine, with a wider blade to ensure incredibly precise cuts. Essential for preparing sushi and sashimi.

Modelo clásico de la cocina oriental, con lámina alargada que garantiza cortes de precisión. Indispensable para preparar sushi y sashimi.

**asian cleaver |  
hachuela  
oriental**

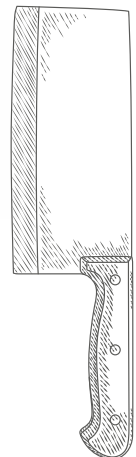

Ideal for slicing and chopping vegetables and proteins.

Ideal para rebanar y picar legumbres, vegetales y proteínas.



# KNIVES CUCHILLOS

## Polywood



Dishwasher safe  
Resistente al lavavajillas



5 years warranty  
5 años de garantía



Impact-resistant  
Resistente a impactos



High temperature resistant  
Resistente a altas temperaturas



Cured wood  
Madera Tratada



watch the video



vea el vídeo

### Colors | Colores



red | rojo



brown | castaño



#### (3") Vegetable and fruit knife / Cuchillo para legumbres y frutas

Ref.	un.	Kg	m <sup>3</sup>	789.1112.	packaging empaque
■ 21118/173	60	2,81	0,021	06901.5	
■ 193				10828.8	



#### (3") Vegetable and fruit knife / Cuchillo para legumbres y frutas

■ 21121/173	60	3,49	0,021	02043.6	
■ 193				10829.5	



#### (5") Steak / fruit knife / Cuchillo para asado / frutas

■ 21122/175	60	3,10	0,015	10830.1	
■ 195				10831.8	



#### (7") Bread knife / Cuchillo para pan

■ 21125/177	60	7,80	0,025	02046.7	
■ 197				10832.5	

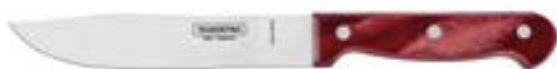

#### (6") Kitchen knife / Cuchillo de cocina

■ 21126/176	60	7,50	0,025	02048.1	
■ 196				10833.2	

**(6", 7", 8") Chef's knife / Cuchillo Chef**

Ref.	un.	Kg	m <sup>3</sup>	789.1112.	packaging empaque
■ 21131/176	60	7,82	0,020	02057.3	
■ 196				10834.9	
■ 177		9,39	0,028	02058.0	
■ 197				10835.6	
■ 178				02059.7	
■ 198	10,33	0,028	10836.3		

**(6", 7") Kitchen knife / Cuchillo de cocina**

■ 21138/176	60	7,95	0,025	10838.7	
■ 196				10839.4	
■ 177		9,65	0,041	10840.0	
■ 197				10841.7	

**(6") Utility knife / Cuchillo utility**

■ 21139/176	60	7,23	0,025	10842.4	
■ 196				10843.1	

**NEW | NUEVO****(7") Santoku knife / Cuchillo Santoku**

■ 21179/177	60	11,37	0,029	31250.0	
■ 197				31251.7	

**(6") Cleaver / Hachuela**

■ 21134/176	60	15,21	0,042	02063.4	
■ 196				10837.0	

**(6") Cleaver / Hachuela**

■ 21140/176	12	5,58	0,008	10844.8	
■ 196				10845.5	

**Carving fork / Tenedor trinchante (32 cm)**

■ 21146/170	60	8,37	0,044	02065.8	
■ 190				10846.2	



**(10") Mincing knife / Cuchillo para picar**

Ref.	un.	Kg	m <sup>3</sup>	789.1112	packaging empaque
■ 21147/170	12	4,12	0,015	02251.5	
■ 190				10847.9	



**(8") Sharpener / Afilador**

Steel SAE 1045 / Acero SAE 1045

■ 21148/178	12	2,47	0,007	02066.5	
■ 198				10848.6	



**4 pcs. Knives set / Juego cuchillos 4 pzas.**

■ 21199/781	10	4,48	0,014	11102.8	
■ 981				11103.5	

**CONTENTS / CONTENIDO**

- 1 - 21121/073 - 3" Vegetable and fruit knife / Cuchillo para legumbres y frutas 3"
- 1 - 21125/077 - 7" Bread knife / Cuchillo para pan 7"
- 1 - 21131/077 - 7" Chef's knife / Cuchillo Chef 7"
- 1 - 21139/076 - 6" Utility knife / Cuchillo Utility 6"



**6 pcs. Knives set / Juego cuchillos 6 pzas.**

■ 21199/783	04	7,19	0,027	11106.6	
■ 983				11107.3	

**CONTENTS / CONTENIDO**

- 1 - 21121/073 - 3" Vegetable and fruit knife / Cuchillo para legumbres y frutas 3"
- 1 - 21122/075 - 5" Steak / fruit knife / Cuchillo para asado / frutas 5"
- 1 - 21125/077 - 7" Bread knife / Cuchillo para pan 7"
- 1 - 21131/077 - 7" Chef's knife / Cuchillo Chef 7"
- 1 - 21139/076 - 6" Utility knife / Cuchillo utility 6"
- 1 - Wooden knife storage / Taco madera



# KNIVES

# CUCHILLOS

## Verttice

- satiny stainless steel blades | láminas de acero inoxidable satinado
- wooden handles | mangos de madera
- stainless steel rivets | remaches de acero inoxidable



watch the video



vea el vídeo



**(3") Vegetable and fruit knife / Cuchillo para legumbres y frutas**

Ref.	un.	Kg	m <sup>3</sup>	789.1112.	packaging empaque
22830/003	04	0,65	0,005	28115.8	<input type="checkbox"/>



**(6") Boning knife / Cuchillo deshuesar**

22831/006	04	0,96	0,007	28116.5	<input type="checkbox"/>
-----------	----	------	-------	---------	--------------------------



**(8") Utility knife / Cuchillo utility**

22833/008	04	1,25	0,007	28118.9	<input type="checkbox"/>
-----------	----	------	-------	---------	--------------------------



**(8") Bread knife / Cuchillo para pan**

22832/008	04	1,19	0,007	28117.2	<input type="checkbox"/>
-----------	----	------	-------	---------	--------------------------



**(8") Chef's knife / Cuchillo Chef**

22834/008	04	1,46	0,008	28119.6	<input type="checkbox"/>
-----------	----	------	-------	---------	--------------------------





# KNIVES CUCHILLOS

## Tradicional

- stainless steel blades | láminas de acero inoxidable
- ipê wooden handles | mangos de madera natural ipê
- aluminum rivets | remaches de aluminio

### (3") Vegetable and fruit knife / Cuchillo para legumbres y frutas

Ref.	un.	Kg	m <sup>3</sup>	789.1112.	packaging empaque
22210/103	60	2,76	0,015	00253.1	1
203	300	17,70	0,074	11607.8	2
403	600	14,56	0,030	19218.8	111
903	20	6,32	0,017	15602.9	12



### (3") Vegetable and fruit knife / Cuchillo para legumbres y frutas

22270/203	300	17,76	0,070	11605.4	2
-----------	-----	-------	-------	---------	---



NEW | NUEVO

### (4") Fruit knife / Cuchillo para frutas

22211/204	300	19,80	0,075	11608.5	2
-----------	-----	-------	-------	---------	---



### (5") Steak knife / Cuchillo asado

22212/105	60	2,91	0,015	00386.6	1
905	20	7,28	0,021	07184.1	12



### (5") Steak knife / Cuchillo para asado

22271/205	300	20,86	0,075	11606.1	2
-----------	-----	-------	-------	---------	---



NEW | NUEVO

### (7") Bread knife / Cuchillo para pan

22215/007	120	10,61	0,020	00600.3	1
107	60	6,86	0,027	00254.8	1



### (6") Kitchen knife / Cuchillo de cocina

22216/006	120	9,96	0,015	00608.9	1
106	60	6,43	0,025	00262.3	1



### (7", 8") Kitchen knife / Cuchillo de cocina

22217/007	120	13,27	0,020	00611.9	1
008		14,25	0,026	00612.6	
107	60	7,99	0,029	00265.4	1
108		8,89	0,041	00266.1	

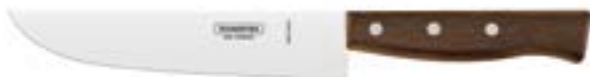



**(9") Carving knife / Cuchillo trinchante**

Ref.	un.	Kg	m <sup>3</sup>	789.1112.	packaging empaque
22218/009	120	15,06	0,027	00602.7	



**(6", 7", 8", 9", 10") Cook's knife / Cuchillo de cocina**

22219/006		9,65	0,016	00603.4	
007		12,42	0,022	00604.1	
008	120	13,87	0,024	00605.8	
009		15,84	0,029	00606.5	
000		17,38	0,026	00607.2	
106		6,21	0,025	00258.6	
107	60	7,65	0,027	00259.3	
108		8,30	0,027	00260.9	



**(8") Sharpener / Afilador**

Steel SAE 1045 / Acero SAE 1045

22229/008		11,54	0,025	04502.6	
108	60	13,22	0,057	04503.3	



**Carving fork / Tenedor trinchante (25 cm)**

22230/000	120	7,15	0,018	01230.1	
-----------	-----	------	-------	---------	--



**Carving fork / Tenedor trinchante (32 cm)**

22231/000	120	11,28	0,026	01028.4	
100	60	7,29	0,044	00268.5	



**(9") Cold cuts knife / Cuchillo para fiambres**

22232/009	120	11,72	0,027	00613.3	
-----------	-----	-------	-------	---------	--



**(6") Cleaver / Hachuela**

22233/006		10,64	0,022	00614.0	
106	60	12,26	0,047	00270.8	



**(6") Cleaver / Hachuela**

22234/106	12	8,63	0,018	00924.0	
-----------	----	------	-------	---------	--



**4 pcs. Cutlery set / Juego de Cuchillos 4 pzas.**

Ref.	un.	Kg	m <sup>3</sup>	789.1112.	packaging empaque
22299/019	20	5,22	0,024	01639.2	4

**CONTENTS / CONTENIDO**

- 1 - 22200/005 - 5" Steak / fruit knife / Cuchillo para asado / frutas 5"
- 1 - 22210/003 - 3" Vegetable and fruit knife / Cuchillo para legumbres y frutas 3"
- 1 - 22220/007 - 7" Chef's knife / Cuchillo Chef 7"
- 1 - 22230/000 - Carving fork / Tenedor trinchante



**8 pcs. Cutlery set / Juego de Cuchillos 8 pzas.**

22299/026	04	6,85	0,027	00034.6	
-----------	----	------	-------	---------	--

**CONTENTS / CONTENIDO**

- 1 - 22200/005 - 5" Steak / fruit knife / Cuchillo para asado / frutas 5"
- 1 - 22210/003 - 3" Vegetable and fruit knife / Cuchillo para legumbres y frutas 3"
- 1 - 22211/004 - 4" Fruit knife / Cuchillo para frutas 4"
- 1 - 22215/007 - 7" Bread knife / Cuchillo para pan 7"
- 1 - 22216/006 - 6" Kitchen knife / Cuchillo de cocina 6"
- 1 - 22220/008 - 8" Cook's knife / Cuchillo de cocina 8"
- 1 - 22230/000 - Carving fork / Tenedor trinchante
- 1 - Wooden knife storage / Taco madera



**4 pcs. Cutlery set / Juego de Cuchillos 4 pzas.**

22299/041	10	3,29	0,009	11061.8	4
-----------	----	------	-------	---------	---

**CONTENTS / CONTENIDO**

- 1 - 22210/003 - 3" Vegetable and fruit knife / Cuchillo para legumbres y frutas 3"
- 1 - 22215/007 - 7" Bread knife / Cuchillo para pan 7"
- 1 - 22216/006 - 6" Kitchen knife / Cuchillo de cocina 6"
- 1 - 22220/008 - 8" Cook's knife / Cuchillo de cocina 8"



# KNIVES

# CUCHILLOS

## Dynamic

- stainless steel blades | láminas de acero inoxidable
- jatobá wooden handles | mangos de madera natural jatobá
- aluminum rivets | remaches de aluminio

### (3") Vegetable and fruit knife / Cuchillo para legumbres y frutas



Ref.	un.	Kg	m <sup>3</sup>	789.1112.	packaging empaque
22310/103	60	3,57	0,019	01665.1	1

### (3") Vegetable and fruit knife / Cuchillo para legumbres y frutas



22340/003	600	15,38	0,036	15604.3	
-----------	-----	-------	-------	---------	--

### (4") Steak / fruit knife / Cuchillo para asado / frutas



22311/204	300	26,49	0,075	11662.7	2
-----------	-----	-------	-------	---------	---

### (5") Steak / fruit knife / Cuchillo para asado / frutas



22312/005	120	6,94	0,013	01572.2	
105	60	5,12	0,025	01667.5	1

### (5") Boning knife / Cuchillo para deshuesar



22313/005	120	6,65	0,013	01573.9	
105	60	4,88	0,025	01668.2	1

### (6") Sandwich knife / Cuchillo para sándwiches



22314/006	120	7,49	0,015	01574.6	
-----------	-----	------	-------	---------	--

### (6", 8") Chef's knife / Cuchillo Chef



22315/006	120	10,91	0,016	01575.3	
008		12,75	0,020	01576.0	
	60	7,12	0,026	01670.5	1
108		8,34	0,027	01671.2	

### (8") Carving knife / Cuchillo trinchante



22316/008	120	11,19	0,018	01577.7	
108	60	7,44	0,029	01672.9	1



**(8") Bread knife / Cuchillo para pan**

Ref.	un.	Kg	m <sup>3</sup>	789.1112.	packaging empaque
22317/008	120	10,78	0,019	01578.4	
108	60	7,18	0,027	01673.6	



**(6") Kitchen knife / Cuchillo de cocina**

22318/006	120	10,25	0,016	02385.7	
106	60	6,81	0,027	02386.4	



**(6") Cleaver / Hachuela**

22319/006	60	10,08	0,017	02389.5	
106		12,28	0,047	02390.1	



**(7") Cleaver / Hachuela**

22328/007	60	20,15	0,014	23697.4	
107		22,63	0,061	23698.1	



**Carving fork / Tenedor trinchante (30 cm)**

22330/100	36	4,12	0,035	02392.5	
-----------	----	------	-------	---------	--



**(5", 6", 7", 8") Kitchen knife / Cuchillo de cocina**

22901/005	240	19,16	0,023	00886.1	
006		20,83	0,026	00887.8	
007		11,45	0,016	00888.5	
008	120	12,39	0,017	00889.2	
105		6,20	0,028	00374.3	
106	60	6,95	0,027	00375.0	
107		7,62	0,028	00376.7	
108		8,19	0,028	00377.4	



**(5", 6", 7", 8", 9") Cook's knife / Cuchillo de cocina  
Ipê wooden handles / Mangos de madera Ipê**

22902/005		6,85	0,009	01498.5	
006		10,50	0,013	01030.7	
007	120	11,52	0,016	01029.1	
008		12,56	0,017	00925.7	
009		14,51	0,019	01031.4	
105		4,67	0,026	01814.3	
106		6,99	0,030	00301.9	
107	60	7,47	0,027	00302.6	
108		8,24	0,028	00303.3	
109		9,19	0,028	00304.0	





**4 pcs. Cutlery set / Juego de cuchillos 4 pzas.**

Ref.	un.	Kg	m <sup>3</sup>	789.1112.	packaging empaque
22399/012	20	6,76	0,025	01636.1	4

**CONTENTS / CONTENIDO**

- 1 - 22310/003 - 3" Vegetable and fruit knife / Cuchillo para legumbres y frutas 3"
- 1 - 22311/004 - 4" Steak / fruit knife / Cuchillo para asado / frutas 4"
- 1 - 22315/008 - 8" Chef's knife / Cuchillo Chef 8"
- 1 - 22317/008 - 8" Bread knife / Cuchillo para pan 8"



**5 pcs. Cutlery set / Juego de cuchillos 5 pzas.**

22399/018	10	8,31	0,028	01630.9	5
-----------	----	------	-------	---------	---

**CONTENTS / CONTENIDO**

- 1 - 22310/003 - 3" Vegetable and fruit knife / Cuchillo para legumbres y frutas 3"
- 1 - 22311/004 - 4" Steak / fruit knife / Cuchillo para asado / frutas 4"
- 1 - 22315/008 - 8" Chef's knife / Cuchillo Chef 8"
- 1 - 22317/008 - 8" Bread knife / Cuchillo para pan 8"
- 1 - 10000/049 - Cutting board / Tabla madera (33,3 x 16,7 cm)



**5 pcs. Knives set / Juego de cuchillos 5 pzas.**

22399/082	08	3,28	0,013	25865.5	5
-----------	----	------	-------	---------	---

**CONTENTS / CONTENIDO**

- 1 - 22310/003 - 3" Vegetable and fruit knife / Cuchillo para legumbres y frutas 3"
- 1 - 22311/004 - 4" Steak / fruit knife / Cuchillo para asado / frutas 4"
- 1 - 22313/005 - 5" Boning knife / Cuchillo para deshuesar 5"
- 1 - 22315/008 - 8" Chef's knife / Cuchillo Chef 8"
- 1 - 22317/008 - 8" Bread knife / Cuchillo para pan 8"





# KNIVES CUCHILLOS

## Carbon

- carbon steel blades | láminas de acero carbono
- wooden handles | mangos de madera
- aluminum rivets | remaches de aluminio



### (5", 6", 7", 8", 9", 10", 12) Cook's knife / Cuchillo de cocina

Ref.	un.	Kg	m <sup>3</sup>	789.1112.	packaging empaque	
22950/005	240	14,32	0,022	01492.3		
006		21,75	0,030	01493.0		
007	120	11,57	0,021	01494.7		
008		12,78	0,017	01026.0		
009		13,77	0,022	01495.4		
000	60	15,90	0,022	01496.1		
002		22,34	0,030	01497.8		
105		4,82	0,021	00365.1		
106	60	6,45	0,025	00366.8		
107		7,54	0,027	00367.5		
108		8,12	0,027	00368.2		
109		9,35	0,028	00369.9		



### (8", 9") Butcher knife / Cuchillo para carne

22952/008	120	23,41	0,031	01266.0	
009		25,75	0,034	01267.7	



### (6") Cleaver / Hachuela

22956/006	60	16,32	0,017	01265.3	
106		17,47	0,047	01946.1	



### (5", 6", 7", 8", 9") Cook's knife / Cuchillo de cocina Dark blade / Lámina obscura

22953/005	240	12,14	0,019	06980.0	
006		16,24	0,028	06981.7	
007	120	8,95	0,017	06982.4	
008		12,62	0,017	06983.1	
009		14,75	0,025	06984.8	



## KNIVES

## CUCHILLOS

## Colorcut

- stainless steel blades with a painted finish | lâminas de acero inoxidable con terminaci3n pintada
- polypropylene handles | mangos de polipropileno



NEW | NUEVO



### 6 pcs. Knives set / Juego de cuchillos 6 pzas.

Ref.	un.	Kg	m <sup>3</sup>	789.1112.	packaging empaque
23099/832	06	5,06	0,040	27893.6	

#### CONTENTS / CONTENIDO

- 1 - 23029/023 - 3" Peeling knife / Cuchillo para torrear 3"
- 1 - 23031/015 - 5" Steak/fruit knife / Cuchillo asado/frutas 5"
- 1 - 23032/038 - 8" Bread knife / Cuchillo para pan 8"
- 1 - 23033/016 - 6" Utility knife / Cuchillo utility 6"
- 1 - 23034/058 - 8" Chef's knife / Cuchillo para Chef 8"
- 1 - 23039/737 - 7" Santoku Knife / Cuchillo Santoku 7"



# KNIVES CUCHILLOS

## Plenus

- stainless steel blades | láminas de acero inoxidable
- polypropylene handles | mangos de polipropileno
- dishwasher safe | resistente a lavavajillas

### Colors | Colores



black | negro



off-white  
cool gray 1c



grey | gris  
cool gray 11c



#### (3") Peeling knife / Cuchillo para tornear

Ref.	un.	Kg	m <sup>3</sup>	789.112.	packaging empaque
■ 23419/003				22488.9	
□ 033	240	6,63	0,017	22489.6	
■ 063				22490.2	
■ 103				22491.9	
□ 133	60	2,83	0,021	22492.6	
■ 163				22493.3	



#### (3") Vegetable and fruit knife / Cuchillo para legumbres y frutas

■ 23420/003				22494.0	
□ 033	240	6,91	0,017	22498.8	
■ 063				22499.5	
■ 103				22497.1	
□ 133	60	2,78	0,021	22495.7	
■ 163				22496.4	



#### (5") Jumbo steak knife / Cuchillo asado jumbo

■ 23421/005	240	13,40	0,025	22501.5	
■ 105	60	4,63	0,025	22552.7	



#### (7", 8") Bread knife / Cuchillo para pan

■ 23422/007				22504.6	
□ 037		9,35	0,019	22505.3	
■ 067	120			22506.0	
■ 008				22510.7	
□ 038		9,69	0,019	22555.8	
■ 068				22512.1	
■ 107				22507.7	
□ 137	60	5,95	0,033	22508.4	
■ 167				22509.1	
■ 108				22513.8	
□ 138		7,00	0,046	22514.5	
■ 168				22515.2	



**(6") Kitchen knife / Cuchillo de cocina**

Ref.	un.	Kg	m <sup>3</sup>	789.1112.	packaging empaque
■ 23423/006				22556.5	
□ 036	120	9,43	0,023	22557.2	
■ 066				22558.9	
■ 106				22559.6	
□ 136	60	5,92	0,031	22560.2	1
■ 166				22561.9	



**(6") Utility knife / Cuchillo utility**

■ 23424/006				22602.9	
□ 036	120	8,75	0,022	22603.6	
■ 066				22604.3	
■ 106				22605.0	
□ 136	60	5,59	0,033	22606.7	1
■ 166				22607.4	



**(5") Boning knife / Cuchillo para deshuesar**

■ 23425/005				22568.8	
□ 035	120	8,41	0,017	22569.5	
■ 065				22570.1	
■ 105				22571.8	
□ 135	60	5,32	0,032	22572.5	1
■ 165				22573.2	



**(6", 7", 8") Chef's knife / Cuchillo Chef**

■ 23426/006				22574.9	
□ 036		10,07	0,022	22575.6	
■ 066				22576.3	
■ 007				22516.9	
□ 037	120	12,04	0,026	22518.3	
■ 067				22519.0	
■ 008				22522.0	
□ 038		12,81	0,026	22524.4	
■ 068				22525.1	
■ 106				22577.0	
□ 136		6,73	0,031	22578.7	1
■ 166				22579.4	
■ 107				22517.6	
□ 137	60	7,89	0,041	22520.6	
■ 167				22521.3	
■ 108				22523.7	
□ 138		8,62	0,041	22526.8	
■ 168				22527.5	



**Carving fork / Tenedor trinchante (26 cm)**

■ 23427/000				22580.0	
□ 030	120	4,58	0,013	22581.7	
■ 060				22582.4	
■ 100				22583.1	
□ 130	60	3,98	0,028	22584.8	1
■ 160				22585.5	





**(5") Tomato knife / Cuchillo para tomates**

Ref.	un.	Kg	m <sup>3</sup>	789.1112.	packaging empaque
■ 23428/005				22534.3	
□ 035	240	7,23	0,019	22535.0	
■ 065				22536.7	
■ 105				22537.4	
□ 135	60	3,11	0,021	22538.1	1
■ 165				22539.8	



**(6") Cheese knife / Cuchillo para queso**

■ 23429/006				22540.4	
□ 036	120	7,67	0,022	22541.1	
■ 066				22542.8	
■ 106				22543.5	
□ 136	60	5,49	0,032	22544.2	1
■ 166				22545.9	



**(5") Cleaver / Hachuela**

■ 23430/005				22546.6	
□ 035		8,60	0,014	22547.3	
■ 065	60			22548.0	
■ 105				22549.7	
□ 135		10,38	0,041	22550.3	1
■ 165				22551.0	



**(5") Fruit knife / Cuchillo para frutas**

■ 23431/005	240	7,63	0,019	23249.5	
■ 105	60	3,08	0,020	23507.6	1



**(5") Fruit knife / Cuchillo para frutas**

■ 23440/005	240	8,23	0,019	23685.1	
■ 105	60	3,40	0,015	23686.8	1



**(5") Santoku knife / Cuchillo Santoku**

■ 23442/105	60	8,74	0,046	23690.5	1
-------------	----	------	-------	---------	---



**(6") Cook's knife / Cuchillo carnicero**

■ 23443/106	60	9,24	0,041	23692.9	1
-------------	----	------	-------	---------	---



**(7") Cook's knife / Cuchillo carnicero**

■ 23444/107	60	11,35	0,041	23694.3	1
-------------	----	-------	-------	---------	---



**(7") Asian cleaver / Hachuela oriental**

Ref.	un.	Kg	m³	789.1112.	packaging empaque
■ 23445/107	60	11,46	0,061	23696.7	1



**(5", 6", 7", 8") Kitchen knife / Cuchillo de cocina**

■ 22920/005	240	15,32	0,024	00893.9	
■ 006		17,13	0,026	00894.6	
■ 007		9,40	0,016	00896.0	
■ 008	120	10,47	0,016	01042.0	<hr/>
■ 105		5,25	0,028	01615.6	
■ 106	60	6,04	0,025	01423.7	1
■ 107		6,34	0,026	01424.4	
■ 108		6,93	0,027	01425.1	



**(6", 7", 8") Kitchen knife / Cuchillo de cocina**

■ 22921/006	120	9,98	0,015	00890.8	
■ 007		10,77	0,016	00891.5	
■ 008		11,86	0,017	00892.2	
■ 106	60	6,64	0,025	00305.7	1
■ 107		6,86	0,027	00306.4	
■ 108		7,83	0,027	00307.1	
□ 186		6,21	0,025	04635.1	



**(5") Fruit knife / Cuchillo para frutas**

■ 22923/005	600	19,67	0,036	01512.8	
-------------	-----	-------	-------	---------	--



**(8") Sharpener / Afilador**

Steel SAE 1045 and polypropylene handle  
Acero SAE 1045 y mango de polipropileno

■ 22969/008	60	8,44	0,025	07788.1	
■ 108		9,63	0,046	07791.1	

**NEW | NUEVO**



**Magnetic knife rack / Barra magnética para cuchillos  
(/110=55cm, /111=38cm)**

26464/110*	08	3,93	0,007	31179.4	
111*		2,63	0,003	31180.0	



**2 pcs. Carving set / Juego trinchante 2 pzas.**

Ref.	un.	Kg	m <sup>3</sup>	789.1112.	packaging empaque
■ 23498/010				22922.8	
□ 310	10	1,87	0,011	22923.5	2
■ 610				22924.2	

CONTENTS / CONTENIDO

- 1 - 23426/067 - 7" Chef's knife / Cuchillo Chef 7"
- 1 - 23427/060 - Carving fork / Tenedor Trinchante (26 cm)



**2 pcs. Set / Juego 2 pzas.**

■ 23498/011				22925.9	
□ 311	10	2,78	0,009	22926.6	2
■ 611				22927.3	

CONTENTS / CONTENIDO

- 1 - 23426/067 - 7" Chef's knife / Cuchillo Chef 7"
- 1 - 22969/768 - 8" Sharpener / Afilador 8"



**3 pcs. Knives Set / Juego de cuchillos 3 pzas.**

■ 23498/012				22928.0	
□ 312	10	1,05	0,005	22929.7	3
■ 612				22930.3	

CONTENTS / CONTENIDO

- 1 - 23419/063 - 3" Peeling knife / Cuchillo para tornear 3"
- 1 - 23420/063 - 3" Vegetable and fruit knife / Cuchillo para legumbres y frutas 3"
- 1 - 23428/065 - 5" Tomato knife / Cuchillo para tomates 5"



**3 pcs. Knives Set / Juego de cuchillos 3 pzas.**

■ 23498/013				22931.0	
□ 313	10	1,65	0,007	22932.7	3
■ 613				22933.4	

CONTENTS / CONTENIDO

- 1 - 23420/063 - 3" Vegetable and fruit knife / Cuchillo para legumbres y frutas 3"
- 1 - 23423/066 - 6" Kitchen knife / Cuchillo de cocina 6"
- 1 - 23428/065 - 5" Tomato knife / Cuchillo para tomates 5"



**3 pcs. Meat and vegetables set /  
Juego para carnes y legumbres 3 pzas.**

Ref.	un.	Kg	m <sup>3</sup>	789.1112.	packaging empaque
■ 23498/014				22934.1	
□ 314	10	5,38	0,026	22935.8	3
■ 614				22936.5	

**CONTENTS / CONTENIDO**

- 1 - 23420/063 - 3" Vegetable and fruit knife / Cuchillo para legumbres y frutas 3"
- 1 - 23426/067 - 7" Chef's knife / Cuchillo Chef 7"
- 1 - 25053/080 - Cutting board / Tabla para cortar (29 x 20 cm)



**6 pcs. Knives Set / Juego de cuchillos 6 pzas.**

23498/916	10	4,23	0,022	22940.2	6
-----------	----	------	-------	---------	---

**CONTENTS / CONTENIDO**

- 1 - 23410/055 - 5" Steak / fruit knife / Cuchillo para asado / frutas 5"
- 1 - 23420/023 - 3" Vegetable and fruit knife / Cuchillo para legumbres y frutas 3"
- 1 - 23422/037 - 7" Bread knife / Cuchillo para pan 7"
- 1 - 23423/096 - 6" Kitchen knife / Cuchillo de cocina 6"
- 1 - 23426/077 - 7" Chef's knife / Cuchillo Chef 7"
- 1 - 23427/730 - Carving fork / Tenedor Trinchante (26 cm)



**8 pcs. Knives Set / Juego de cuchillos 8 pzas.**

23498/917	10	5,63	0,029	22941.9	8
-----------	----	------	-------	---------	---

**CONTENTS / CONTENIDO**

- 1 - 23410/055 - 5" Steak / fruit knife / Cuchillo para asado / frutas 5"
- 1 - 23419/043 - 3" Peeling knife / Cuchillo para torrear 3"
- 1 - 23420/023 - 3" Vegetable and fruit knife / Cuchillo para legumbres y frutas 3"
- 1 - 23422/037 - 7" Bread knife / Cuchillo para pan 7"
- 1 - 23423/096 - 6" Kitchen knife / Cuchillo de cocina 6"
- 1 - 23426/077 - 7" Chef's knife / Cuchillo Chef 7"
- 1 - 23428/744 - 4" Tomato knife / Cuchillo para tomates 4"
- 1 - 25950/718 - 8" Sewing scissor / Tijera para coser 8"



**6 pcs. knives set / Juego de cuchillos 6 pzas.**

■ 23498/015				22937.2	
□ 315	04	5,59	0,026	22938.9	3
■ 615				22939.6	

**CONTENTS / CONTENIDO**

- 1 - 23410/065 - 5" Steak / fruit knife / Cuchillo para asado / frutas 5"
- 1 - 23420/063 - 3" Vegetable and fruit knife / Cuchillo para legumbres y frutas 3"
- 1 - 23423/066 - 6" Kitchen knife / Cuchillo de cocina 6"
- 1 - 23426/067 - 7" Chef's knife / Cuchillo Chef 7"
- 1 - 25950/068 - 8" Sewing scissor / Tijera pra coser 8"
- 1 - 10558/089 - Wooden knife storage / Taco madera



**6 pcs. Knives set / Juego de cuchillos 6 pzas.**

Ref.	un.	Kg	m <sup>3</sup>	789.1112.	packaging empaque
23498/028	04	5,82	0,041	24826.7	

**CONTENTS / CONTENIDO**

- 1 - 23420/003 - 3" Vegetable and fruit knife / Cuchillo para legumbres y frutas 3"
- 1 - 23425/005 - 5" Boning knife / Cuchillo para deshuesar 5"
- 1 - 23426/007 - 7" Chef's knife / Cuchillo Chef 7"
- 1 - 23428/005 - 5" Tomato knife / Cuchillo tomate 5"
- 1 - 23432/000 - Carving fork / Tenedor trinchante (26 cm)
- 1 - 29900/500 - Wooden and plastic knife storage / Taco de madera y plastico



**4 pcs. Knives set / Juego de cuchillos 4 pzas.**

<input checked="" type="checkbox"/> 23498/031	10	2,86	0,015	25300.1	
<input type="checkbox"/> 331				25301.8	4

**CONTENTS / CONTENIDO**

- 1 - 23420/003 - 3" Vegetable and fruit knife / Cuchillo para legumbres y frutas 3"
- 1 - 23425/005 - 5" Boning knife / Cuchillo para deshuesar 5"
- 1 - 23426/007 - 7" Chef's knife / Cuchillo Chef 7"
- 1 - 23427/000 - Carving fork / Tenedor trinchante



**8 pcs. Knives set / Juego de cuchillos 8 pzas.**

<input checked="" type="checkbox"/> 23498/032	10	7,09	0,027	25339.1	
<input type="checkbox"/> 332				25340.7	8

**CONTENTS / CONTENIDO**

- 1 - 23410/005 - 5" Steak / fruit knife / Cuchillo para asado / frutas 5"
- 1 - 23420/003 - 3" Vegetable and fruit knife / Cuchillo para legumbres y frutas 3"
- 1 - 23422/007 - 7" Bread knife / Cuchillo para pan 7"
- 1 - 23425/005 - 5" Boning knife / Cuchillo para deshuesar 5"
- 1 - 23426/007 - 7" Chef's knife / Cuchillo Chef 7"
- 1 - 23428/005 - 5" Tomato Knife / Cuchillo Tomate 5"
- 1 - 23429/006 - 6" Cheese knife / Cuchillo para queso 6"
- 1 - 23430/005 - 5" Cleaver / Hachuela 5"





## KNIVES

## CUCHILLOS

## Affilata

- stainless steel blades | láminas de acero inoxidable
- polypropylene handles | mangos de polipropileno
- dishwasher safe | resistente a lavavajillas



**(3") Vegetable and fruit knife / Cuchillo para legumbres y frutas**

Ref.	un.	Kg	m <sup>3</sup>	789.1112.	packaging empaque
23650/103	60	3,58	0,025	24856.4	1



**(5") Steak/fruit knife / Cuchillo asado/frutas**

23651/105	60	3,88	0,025	24858.8	1
-----------	----	------	-------	---------	---



**(8") Bread knife / Cuchillo para pan**

23652/108	60	6,02	0,041	24860.1	1
-----------	----	------	-------	---------	---



**(5") Boning knife / Cuchillo deshuesar**

23653/105	60	4,78	0,025	24862.5	1
-----------	----	------	-------	---------	---



**(8") Chef's knife / Cuchillo Chef**

23654/108	60	6,92	0,041	24866.3	1
-----------	----	------	-------	---------	---



**(7") Utility knife / Cuchillo Utility**

23655/107	60	6,02	0,041	24868.7	1
-----------	----	------	-------	---------	---



**Carving fork / Tenedor trinchante (27 cm)**

23656/100	60	4,20	0,031	24870.0	1
-----------	----	------	-------	---------	---



**(5") Tomato knife / Cuchillo para tomates**

Ref.	un.	Kg	m <sup>3</sup>	789.1112.	packaging empaque
23657/105	60	3,88	0,025	24872.4	1



**(5") Cleaver / Hachuela**

23658/105	60	9,32	0,041	24874.8	1
-----------	----	------	-------	---------	---



**3 pcs. Knives set / Juego de cuchillos 3 pzas.**

23699/050	04	1,49	0,009	24875.5	1
-----------	----	------	-------	---------	---

**CONTENTS / CONTENIDO**

- 1 - 23650/003 - 3" Vegetable and fruit knife / Cuchillo para legumbres y frutas 3"
- 1 - 23653/005 - 5" Boning knife / Cuchillo deshuesar 5"
- 1 - 23654/008 - 8" Chef's knife / Cuchillo Chef 8"



**9 pcs. Knives set / Juego de cuchillos 9 pzas.**

23699/051	04	4,07	0,027	24876.2	1
-----------	----	------	-------	---------	---

**CONTENTS / CONTENIDO**

- 1 - 23650/003 - 3" Vegetable and fruit knife / Cuchillo para legumbres y frutas 3"
- 1 - 23651/005 - 5" Steak / fruit knife / Cuchillo asado / frutas 5"
- 1 - 23652/008 - 8" Bread knife / Cuchillo para pan 8"
- 1 - 23653/005 - 5" Boning knife / Cuchillo deshuesar 5"
- 1 - 23654/008 - 8" Chef's knife / Cuchillo Chef 8"
- 1 - 23655/007 - 7" Utility knife / Cuchillo Utility 7"
- 1 - 23656/000 - Carving fork / Tenedor trinchante
- 1 - 23657/005 - 5" Tomato knife / Cuchillo tomates 5"
- 1 - 23658/005 - 5" Cleaver / Hachuela 5"



**7 pcs. Knives set / Juego de cuchillos 7 pzas.**

23699/054	04	4,27	0,027	26490.8	1
-----------	----	------	-------	---------	---

**CONTENTS / CONTENIDO**

- 1 - 23650/003 - 3" Vegetable and fruit knife / Cuchillo para legumbres y frutas 3"
- 1 - 23652/008 - 8" Bread knife / Cuchillo para pan 8"
- 1 - 23653/005 - 5" Boning knife / Cuchillo deshuesar 5"
- 1 - 23654/008 - 8" Chef's knife / Cuchillo Chef 8"
- 1 - 23655/007 - 7" Utility knife / Cuchillo Utility 7"
- 1 - 23657/005 - 5" Tomato knife / Cuchillo tomates 5"
- 1 - 26464/001 - 38 cm Magnetic knives rack / Barra magnética para cuchillos 38 cm



# KNIVES

# CUCHILLOS

## Multicolor

- stainless steel blades | láminas de acero inoxidable
- polypropylene handles | mangos de polipropileno
- dishwasher safe | resistente a lavavajillas

### (3") Vegetable and fruit knife / Cuchillo para legumbres y frutas



Ref.	un.	Kg	m³	789.1112.	packaging empaque
23511/013	600	18,47	0,049	02312.3	III
213	300	20,15	0,071	11742.6	2
913	600	23,44	0,136	15617.3	1



### (3") Vegetable and fruit knife / Cuchillo para legumbres y frutas

23528/013	600	18,68	0,037	03321.4	III
213	300	20,75	0,072	11777.8	2



### (5") Steak knife / Cuchillo para asado

23500/015	600	22,02	0,037	02313.0	III
215	300	21,71	0,074	11735.8	2
915	600	24,98	0,136	15618.0	1



### (5") Steak knife / Cuchillo para asado

23527/015	600	22,40	0,074	03852.3	III
215	300	22,60	0,071	11756.3	2
915	600	24,94	0,136	15619.7	1



### (5") Steak knife / Cuchillo para asado

23529/015	600	20,26	0,037	03322.1	III
215	300	22,85	0,079	11784.6	2

### (3", 4", 5") Tomato knife / Cuchillo para tomate



23512/013		17,50	0,036	05479.0	
014	600	18,90	0,050	05480.6	III
015		19,35	0,050	02314.7	
213		19,62	0,071	11749.5	
214	300	20,93	0,073	11757.0	2
215		21,70	0,074	11764.8	
915	600	24,32	0,136	15620.3	1

NEW | NUEVO



**(6") Kitchen knife / Cuchillo de cocina**

Ref.	un.	Kg	m³	789.1112.	packaging empaque
23522/016	120	8,39	0,018	05741.8	III
116	60	5,72	0,027	05747.0	I

NEW | NUEVO



**(3") Butter spreader / Espatula para matequilla**

23521/013	600	12,20	0,023	04559.0	III
-----------	-----	-------	-------	---------	-----







# KNIVES

# CUCHILLOS

## Ultracorte

- stainless steel blades | lâminas de acero inoxidable
- polypropylene handles | mangos de polipropileno
- aluminum rivets | remaches de aluminio
- dishwasher safe | resistente a lavavajillas



### (3") Vegetable and fruit knife / Cuchillo para legumbres y frutas



Ref.	un.	Kg	m <sup>3</sup>	789.1112.	packaging empaque
23850/103	60	2,85	0,020	06807.0	

### (3") Peeling knife / Cuchillo para torneare



23851/103	60	2,69	0,012	11018.2	
-----------	----	------	-------	---------	--

### (5") Tomato knife / Cuchillo para tomate



23852/105	60	3,04	0,021	26178.5	
-----------	----	------	-------	---------	--

### (6") Cheese knife / Cuchillo para queso



23866/106	60	5,13	0,026	28442.5	
-----------	----	------	-------	---------	--

### (6") Boning knife / Cuchillo para deshuesar



23853/106	60	5,15	0,017	26180.8	
-----------	----	------	-------	---------	--

### (5") Steak / fruit knife / Cuchillo para asado / frutas



23854/105	60	3,04	0,021	06809.4	
-----------	----	------	-------	---------	--

### (6", 7") Kitchen knife / Cuchillo de cocina



23856/106	60	5,96	0,025	06812.4	
-----------	----	------	-------	---------	--

### (6", 7") Kitchen knife / Cuchillo de cocina



23857/106	60	6,29	0,025	06816.2	
107		7,73	0,031	06817.9	

### (8") Carving knife / Cuchillo trinchante



23858/108	60	6,80	0,031	06819.3	
-----------	----	------	-------	---------	--





**(7") Bread knife / Cuchillo para pan**

Ref.	un.	Kg	m <sup>3</sup>	789.1112.	packaging empaque
23859/107	60	6,10	0,027	06821.6	



**(4") Vegetable and fruit knife / Cuchillo para legumbres y frutas**

23860/104	60	2,66	0,021	25055.0	
-----------	----	------	-------	---------	--



**(6") Utility knife / Cuchillo utility**

23860/106	60	5,75	0,027	06823.0	
-----------	----	------	-------	---------	--



**(6", 7", 8") Chef's knife / Cuchillo Chef**

23861/106		6,76	0,025	06827.8	
107	60	7,72	0,028	06828.5	
108		8,53	0,033	06829.2	



**(6") Cleaver / Hachuela**

23864/106	60	14,52	0,047	06831.5	
-----------	----	-------	-------	---------	--



**Carving fork / Tenedor trinchante (30 cm)**

23865/100	60	6,48	0,045	06833.9	
-----------	----	------	-------	---------	--



**(7") Santoku knife / Cuchillo Santoku**

23868/107	60	9,02	0,028	08468.1	
-----------	----	------	-------	---------	--



**(8") Sharpener / Afilador**

Steel SAE 1045 / Acero SAE 1045

24641/108	60	14,41	0,076	06837.7	
-----------	----	-------	-------	---------	--



**3 pcs. Knives set / Juego cuchillos 3 pzas.**

23899/051	20	3,33	0,011	06854.4	
-----------	----	------	-------	---------	--

**CONTENTS / CONTENIDO**

1 - 23850/003 - 3" Vegetable and fruit knife / Cuchillo para legumbres y frutas 3"

1 - 23854/005 - 5" Steak / fruit knife / Cuchillo asado / frutas 5"

1 - 23856/006 - 6" Kitchen knife / Cuchillo de cocina 6"



**6 pcs. Knives set / Juego de cuchillos 6 pzas.**

Ref.	un.	Kg	m <sup>3</sup>	789.1112.	packaging empaque
23899/060	04	5,41	0,021	07829.1	

**CONTENTS / CONTENIDO**

- 1 - 23850/003 - 3" Vegetable and fruit knife / Cuchillo para legumbres y frutas 3"
- 1 - 23854/005 - 5" Steak / fruit knife / Cuchillo asado / frutas 5"
- 1 - 23856/006 - 6" Kitchen knife / Cuchillo de cocina 6"
- 1 - 23861/007 - 7" Chef's knife / Cuchillo Chef 7"
- 1 - 25950/007 - 7" Sewing scissor / Tijera para coser 7"
- 1 - 10558/089 - Wooden knife storage / Taco madera



**4 pcs. Knives set / Juego de cuchillos 4 pzas.**

23899/061	16	5,01	0,026	07722.5	
-----------	----	------	-------	---------	---

**CONTENTS / CONTENIDO**

- 1 - 23850/003 - 3" Vegetable and fruit knife / Cuchillo para legumbres y frutas 3"
- 1 - 23854/005 - 5" Steak / fruit knife / Cuchillo asado / frutas 5"
- 1 - 23856/006 - 6" Kitchen knife / Cuchillo de cocina 6"
- 1 - 23861/007 - 7" Chef's knife / Cuchillo Chef 7"



**3 pcs. Cutlery set / Juego de cuchillos 3 pzas.**

23899/072	10	3,71	0,014	17559.4	
-----------	----	------	-------	---------	---

**CONTENTS / CONTENIDO**

- 1 - 22969/008 - 8" Sharpener / Afilador 8"
- 1 - 23860/006 - 6" Utility knife / Cuchillo Utility 6"
- 1 - 23861/007 - 7" Chef's knife / Cuchillo Chef 7"



**6 pcs. Knives set / Juego de cuchillos 6 pzas.**

23899/078	04	4,87	0,030	26506.6	
-----------	----	------	-------	---------	---

**CONTENTS / CONTENIDO**

- 1 - 23850/003 - 3" Vegetable and fruit knife / Cuchillo para legumbres y frutas 3"
- 1 - 23852/005 - 5" Tomato knife / Cuchillo para tomate 5"
- 1 - 23859/007 - 7" Bread knife / Cuchillo para pan 7"
- 1 - 23860/006 - 6" Utility knife / Cuchillo Utility 6"
- 1 - 23861/008 - 8" Chef's knife / Cuchillo Chef 8"
- 1 - 29900/505 - Knife block / Soporte



# KNIVES CUCHILLOS

## Premium

- stainless steel blades | láminas de acero inoxidable
- injection molded polypropylene handles over the tang | mangos de polipropileno inyectados sobre la espiga de la lámina
- dishwasher safe | resistente a lavavajillas

### (4") Vegetable and fruit knife / Cuchillo para legumbres y frutas



Ref.	un.	Kg	m <sup>3</sup>	789.1112.	packaging empaque
24470/184	60	3,19	0,015	08271.7	1

### (5") Boning knife / Cuchillo para deshuesar



24471/185	60	6,18	0,030	08273.1	1
-----------	----	------	-------	---------	---

### (6",8") Utility knife / Cuchillo Utility



24472/186	60	6,95	0,030	08276.2	1
188		9,34	0,051	08277.9	

### (7",8",10") Kitchen knife / Cuchillo de cocina



24473/187	60	9,13	0,051	08282.3	1
188		11,28	0,051	08283.0	
180		13,49	0,065	08281.6	

### (6") Boning knife / Cuchillo para deshuesar



24474/186	60	6,62	0,033	08285.4	1
-----------	----	------	-------	---------	---

### (8",10") Butcher's knife / Cuchillo para carne



24475/188	60	11,43	0,051	08289.2	1
180		14,49	0,065	08288.5	

### (8",10") Chef's knife / Cuchillo Chef



24476/188	60	11,59	0,051	08293.9	1
180		14,14	0,065	08292.2	



**(8") Sharpener / Afilador**

Steel SAE 1045 / Acero SAE 1045

Ref.	un.	Kg	m³	789.1112	packaging empaque
22969/188	60	9,89	0,047	08464.3	1



**3 pcs. Knives set / Juego de cuchillos 3 pzas.**

24499/811	10	2,77	0,010	08656.2	3
-----------	----	------	-------	---------	---

**CONTENTS / CONTENIDO**

1 - 24470/084 - 4" Vegetable and fruit knife / Cuchillo para legumbres y frutas 4"

1 - 24472/086 - 6" Utility knife / Cuchillo utility 6"

1 - 24473/087 - 7" Kitchen knife / Cuchillo de cocina 7"



**3 pcs. Knives set / Juego de cuchillos 3 pzas.**

24499/812	20	7,36	0,025	09635.6	3
-----------	----	------	-------	---------	---

**CONTENTS / CONTENIDO**

1 - 22969/088 - 8" Sharpener / Afilador 8"

1 - 24471/085 - 5" Boning knife / Cuchillo para deshuesar 5"

1 - 24472/088 - 8" Utility knife / Cuchillo utility 8"



# KNIVES

## CUCHILLOS

### Nygma

- stainless steel blades with a black finish | láminas de acero inoxidable con revestimiento negro
- polypropylene handle with special texture | mango de polipropileno con textura especial



watch the video



vea el video



NEW | NUEVO



#### (3") Peeling knife / Cuchillo para tornear

Ref.	un.	Kg	m <sup>3</sup>	789.1112.	packaging empaque
23680/103	12	1,63	0,014	29250.5	<input type="checkbox"/>

NEW | NUEVO



#### (5") Steak/fruit knife / Cuchillo para asado/frutas

23681/105	12	1,69	0,014	29251.2	<input type="checkbox"/>
-----------	----	------	-------	---------	--------------------------

NEW | NUEVO



#### (8") Bread knife / Cuchillo para pan

23682/108	12	2,50	0,018	29252.9	<input type="checkbox"/>
-----------	----	------	-------	---------	--------------------------

NEW | NUEVO



#### (6") Utility knife / Cuchillo utility

23683/106	12	2,36	0,018	29253.6	<input type="checkbox"/>
-----------	----	------	-------	---------	--------------------------

NEW | NUEVO



#### (8") Chef's knife / Cuchillo Chef

23684/108	12	2,72	0,018	29254.3	<input type="checkbox"/>
-----------	----	------	-------	---------	--------------------------

NEW | NUEVO



#### (7") Santoku knife / Cuchillo Santoku

23685/107	12	2,66	0,018	29255.0	<input type="checkbox"/>
-----------	----	------	-------	---------	--------------------------





**3 pcs. Knives set / Juego de cuchillos 3 pzas.**

Ref.	un.	Kg	m <sup>3</sup>	789.1112.	packaging empaque
23699/080	04	1,64	0,012	27909.4	

**CONTENTS / CONTENIDO**

- 1 - 23680/003 - 3" Peeling knife / Cuchillo para tornear 3"
- 1 - 23683/006 - 6" Utility knife / Cuchillo utility 6"
- 1 - 23684/008 - 8" Chef's knife / Cuchillo Chef 8"



**6 pcs. Knives set / Juego de cuchillos 6 pzas.**

23699/081	04	3,26	0,026	27910.0	
-----------	----	------	-------	---------	--

**CONTENTS / CONTENIDO**

- 1 - 23680/003 - 3" Peeling knife / Cuchillo para tornear 3"
- 1 - 23681/005 - 5" Steak / fruit knife / Cuchillo para asado / frutas 5"
- 1 - 23682/008 - 8" Bread knife / Cuchillo para pan 8"
- 1 - 23683/006 - 6" Utility knife / Cuchillo utility 6"
- 1 - 23684/008 - 8" Chef's knife / Cuchillo Chef 8"
- 1 - 23685/007 - 7" Santoku knife / Cuchillo Santoku 7"





# KNIVES

---

# CUCHILLOS

Certified by NSF, National Sanitation Foundation, an international organization, recognised by food safety monitoring and hygienic practices in food companies and restaurants.

Certificada por el NSF, National Sanitation Foundation, organización internacionalmente reconocida en monitoreo de seguridad de alimentos y practicas de higiene en empresas de alimentos y restaurantes.

Special stainless steel blade, tempered by sub-zero process and stress relieving which guarantees edge precision and a smooth cut.

Lámina de acero inoxidable especial, tratada por los procesos de temple sub-cero y revenimiento proporcionando un filo más preciso y durable.

The V-sharped edge ensures a precise cut and excellent performance, even after being sharpened many times.

Desbaste en forma "V" asegura un corte confiable y un mejor rendimiento mismo despues de muchos afilados.

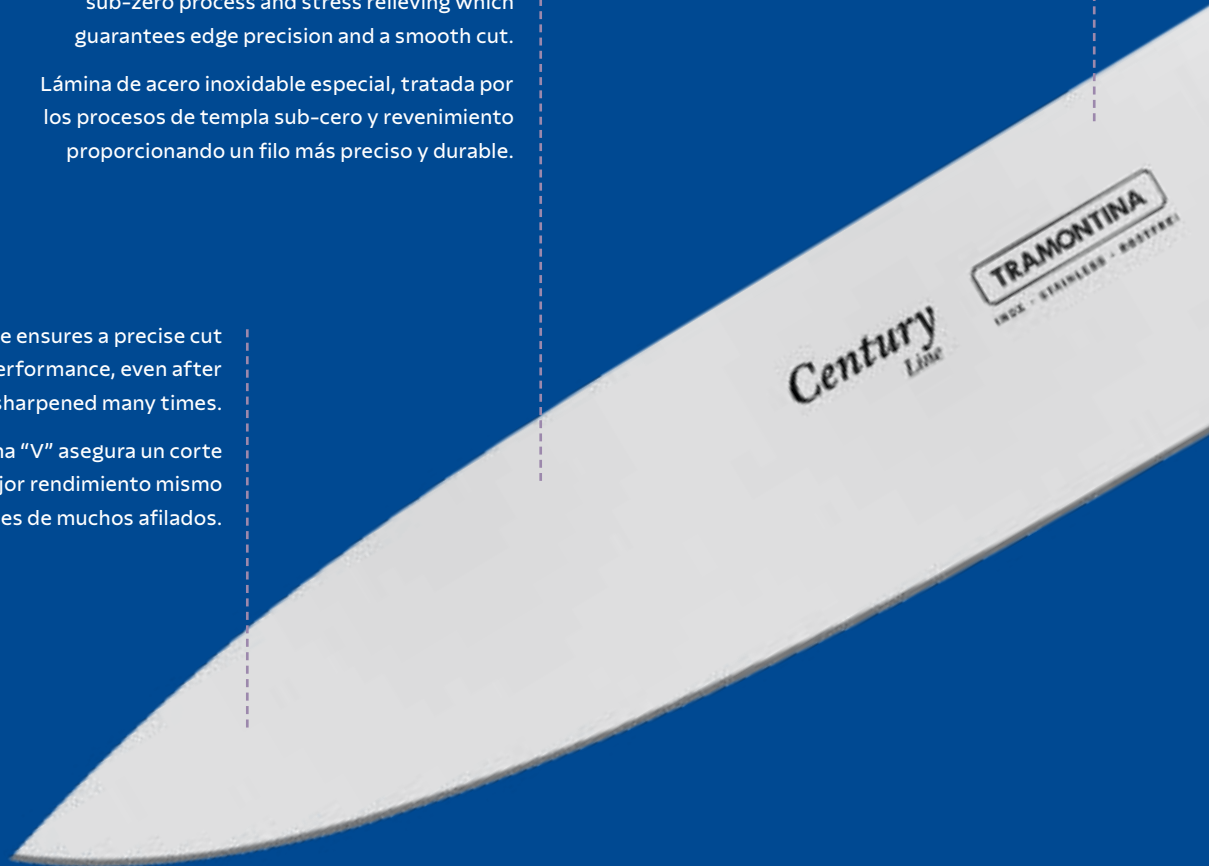

# CENTURY



Rivets fix the handle much better.  
Remaches que auxilian en la fijación del mango.

The polycarbonate handle with fiberglass injected in a single blade is light, anatomic and perfectly ergonomic, providing comfort, firmness and safety at the moment of cutting.

Mango de policarbonato con fibra de vidrio, injetado sobre la espiga de la hoja, anatómico y con ergonomía perfecta proporcionando confort, equilibrio y seguridad en la hora de cortar.

Forged blade in a single piece (monobloc) which guarantees product resistance and durability.

Lámina forjada en una sola pieza (monobloco) lo que garantiza resistencia y durabilidad del producto.



Revised in February 2022  
Revisado en Febrero 2022



# KNIVES CUCHILLOS

Century



Revised in February 2022  
Revisado en Febrero 2022



### (3") Vegetable and fruits knife / Cuchillo para legumbres y frutas



Ref.	un.	Kg	m <sup>3</sup>	789.1112.	packaging empaques
24000/003	12	0,75	0,001	02478.6	
103	06	0,76	0,005	02479.3	

### (3") Peeling knife / Cuchillo para tornear



24001/003	12	0,71	0,001	01126.7	
103	06	0,78	0,005	01166.3	

### (3") Vegetable and fruits knife / Cuchillo para legumbres y frutas



24002/003	12	0,70	0,001	01127.4	
103	06	0,76	0,005	01165.6	



### (5") Steak knife / Cuchillo asado

24003/005	12	0,75	0,001	00487.0	
105	06	0,91	0,006	00569.3	

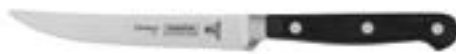

### (5") Steak / fruit knife / Cuchillo para asado / frutas

24004/005	12	0,74	0,001	01699.6	
105	06	0,89	0,006	01952.2	



### (5") Tomato knife / Cuchillo para tomate

24048/005	12	0,75	0,001	28437.1	
105	06	0,89	0,006	28439.5	



### (6") Cheese knife / Cuchillo para queso

24049/006	12	1,22	0,002	28438.8	
106	06	1,12	0,007	28440.1	

**(6") Boning knife / Cuchillo para deshuesar**

Ref.	un.	Kg	m <sup>3</sup>	789.1112.	packaging empaque
24006/006	12	1,60	0,002	00488.7	
106	06	1,33	0,007	00570.9	

**(6", 7") Kitchen knife / Cuchillo de cocina**

24007/006	12	1,27	0,001	02487.8	
007		1,35	0,001	02488.5	
106	06	1,18	0,007	02484.7	
107		1,18	0,007	02485.4	

**(8") Bread knife / Cuchillo para pan**

24009/008	12	1,98	0,002	01125.0	
108	06	1,73	0,011	01176.2	

**(4") Vegetable and fruit knife / Cuchillo para legumbres y frutas**

24010/004	12	0,73	0,001	00489.4	
104	06	0,87	0,006	00571.6	

**(6", 8") Utility knife / Cuchillo utility**

24010/006	12	1,28	0,001	00490.0	
008		2,04	0,002	00491.7	
106	06	1,18	0,008	00572.3	
108		1,67	0,010	00573.0	

**(10") Butcher's knife / Cuchillo para carne**

24010/010	12	2,24	0,002	00492.4	
110	06	1,91	0,012	00574.7	

**(6", 8", 10") Chef's knife / Cuchillo Chef**

24011/006	12	2,29	0,002	00493.1	
008		3,30	0,005	00494.8	
010		3,78	0,004	00495.5	
106	06	1,60	0,007	00575.4	
108		2,33	0,011	00576.1	
110		2,72	0,011	00577.8	

**(10") Pastry knife / Cuchillo para confitería**

24012/010	12	2,05	0,002	00496.2	
110	06	1,85	0,011	00578.5	





**(10") Cold cuts knife / Cuchillo para fiambres**

Ref.	un.	Kg	m <sup>3</sup>	789.1112	packaging empaque
24013/010	12	1,80	0,002	00497.9	
110	06	1,70	0,011	00579.2	



**Carving fork / Tenedor trinchante (30 cm)**

24215/000	12	1,70	0,002	04085.4	
100	06	1,42	0,008	04482.1	



**(10") Sharpener / Afilador**

Steel SAE 6150 or 9254 / Acero Sae 6150 o 9254

24017/010*	12	3,02	0,007	00499.3	
110*	06	2,67	0,018	01598.2	

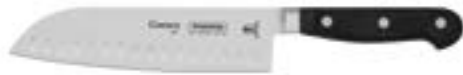

**(4", 5", 7") Santoku knife / Cuchillo Santoku**

24020/004		0,97	0,001	22803.0	
005	12	1,36	0,001	09008.8	
007		2,38	0,002	07163.6	
104		1,11	0,007	22804.7	
105	06	1,21	0,007	09009.5	
107		1,91	0,011	07595.5	



**(5") Steak knife / Cuchillo asado**

24021/005	12	0,98	0,001	07164.3	
105	06	0,99	0,007	07596.2	



**(5") Jumbo steak knife / Cuchillo asado jumbo**

24022/005	12	1,27	0,001	08402.5	
-----------	----	------	-------	---------	--



**(5") Jumbo steak knife / Cuchillo para asado jumbo**

24085/005	120	15,40	0,017	31070.4	
-----------	-----	-------	-------	---------	--



**(6") Fillet knife / Cuchillo para filetear**

24023/006	12	1,56	0,002	12989.4	
106	06	1,33	0,007	13692.2	

\* Without NSF certificate. | No tiene chancela del NSF.



**(7") Cook's knife / Cuchillo carnicero**

Ref.	un.	Kg	m <sup>3</sup>	789.1112.	packaging empaque
24024/007	12	2,87	0,002	09003.3	
107	06	2,21	0,011	09010.1	



**(7") Cook's knife / Cuchillo carnicero**

24025/007	12	2,46	0,002	09004.0	
107	06	1,99	0,011	09011.8	



**(6") Cleaver / Hachuela**

24014/006	12	6,79	0,005	00498.6	
106	06	4,10	0,013	00664.5	



**(7") Asian cleaver / Hachuela oriental**

24026/107	06	2,90	0,013	13476.8	
-----------	----	------	-------	---------	--



**2 pcs. Carving set / Juego trinchante 2 pzas.**

24099/017	05	2,72	0,014	07591.7	
-----------	----	------	-------	---------	--

CONTENTS / CONTENIDO  
 1 - 24011/008 - 8" Chef's knife / Cuchillo Chef 8"  
 1 - 24215/000 - Carving fork / Tenedor trinchante



**3 pcs. Cutlery set / Juego de cuchillos 3 pzas.**

24099/037	05	2,97	0,014	22817.7	
-----------	----	------	-------	---------	--

CONTENTS / CONTENIDO  
 1 - 24000/003 - 3" Vegetable and fruit knife / Cuchillo para legumbres y frutas 3"  
 1 - 24010/006 - 6" Utility knife / Cuchillo Utility 6"  
 1 - 24011/008 - 8" Chef's knife / Cuchillo Chef 8"



**8 pcs. Cutlery set / Juego de cuchillos 8 pzas.**

Ref.	un.	Kg	m <sup>3</sup>	789.1112.	packaging empaque
24099/035	02	10,11	0,037	22805.4	

**CONTENTS / CONTENIDO**

- 1 - 24000/003 - 3" Vegetable and fruit knife / Cuchillo para legumbres y frutas 3"
- 1 - 24009/008 - 8" Bread knife / Cuchillo para pan 8"
- 1 - 24010/006 - 6" Utility knife / Cuchillo Utility 6"
- 1 - 24011/008 - 8" Chef's knife / Cuchillo Chef 8"
- 1 - 24015/000 - Carving fork / Tenedor trinchante
- 1 - 24017/010\* - 10" Sharpener / Afilador 10"
- 1 - 25922/008 - 8" Household scissor / Tijera uso doméstico 8"
- 1 - 10580/080 - Wooden knife storage / Taco madera



**6 pcs. Cutlery set / Juego de cuchillos 6 pzas.**

24099/036	02	5,33	0,027	22806.1	
-----------	----	------	-------	---------	--

**CONTENTS / CONTENIDO**

- 1 - 24000/003 - 3" Vegetable and fruit knife / Cuchillo para legumbres y frutas 3"
- 1 - 24004/005 - 5" Steak / fruit knife / Cuchillo para asado / frutas 5"
- 1 - 24010/006 - 6" Utility knife / Cuchillo Utility 6"
- 1 - 24011/008 - 8" Chef's knife / Cuchillo Chef 8"
- 1 - 24015/000 - Carving fork / Tenedor trinchante
- 1 - 10579/080 - Wooden knife storage / Taco madera



**7 pcs. Cutlery set / Juego de cuchillos 7 pzas.**

24099/016	05	15,09	0,057	07051.6	
-----------	----	-------	-------	---------	--

**CONTENTS / CONTENIDO**

- 1 - 24000/003 - 3" Vegetable and fruit knife / Cuchillo para legumbres y frutas 3"
- 1 - 24004/005 - 5" Steak / fruits knife / Cuchillo asado / frutas 5"
- 1 - 24006/006 - 6" Boning knife / Cuchillo para deshuesar 6"
- 1 - 24009/008 - 8" Bread knife / Cuchillo para pan 8"
- 1 - 24010/006 - 6" Utility knife / Cuchillo Utility 6"
- 1 - 24011/008 - 8" Chef's knife / Cuchillo Chef 8"
- 1 - 29900/502 - Knife storage / Taco



**6 pcs. Cutlery set / Juego de cuchillos 6 pzas.**

24099/020	05	5,68	0,020	07953.3	
-----------	----	------	-------	---------	--

**CONTENTS / CONTENIDO**

- 1 - 24001/003 - 3" Peeling knife / Cuchillo para tornejar 3"
- 1 - 24010/006 - 6" Utility knife / Cuchillo Utility 6"
- 1 - 24011/008 - 8" Chef's knife / Cuchillo Chef 8"
- 1 - 24215/000\* - Carving fork / Tenedor trinchante
- 1 - 24641/008 - 8" Sharpener / Afilador 8"
- 1 - 29900/553 - Synthetic case / Estuche sintético

\* Without NSF certificate. | No tiene chancela del NSF.



**10 pcs. Cutlery set / Juego de cuchillos 10 pzas.**

Ref.	un.	Kg	m <sup>3</sup>	789.1112.	packaging empaque
24099/021	05	10,68	0,033	07954.0	

- CONTENTS / CONTENIDO
- 1 - 24001/003 - 3" Peeling knife / Cuchillo para tornejar 3"
  - 1 - 24006/006 - 6" Boning knife / Cuchillo para deshuesar 6"
  - 1 - 24009/008 - 8" Bread knife / Cuchillo para pan 8"
  - 1 - 24010/006 - 6" Utility knife / Cuchillo Utility 6"
  - 1 - 24011/008 - 8" Chef's knife / Cuchillo Chef 8"
  - 1 - 24214/006 - 6" Cleaver / Hachuela 6"
  - 1 - 24215/000\* - Carving fork / Tenedor trinchante
  - 1 - 24641/008 - 8" Sharpener / Afilador 8"
  - 1 - 25922/008 - 8" Household scissor / Tijera uso doméstico 8"
  - 1 - 29900/552 - Synthetic case / Estuche sintético



**6 pcs. Cutlery set / Juego de cuchillos 6 pzas.**

24099/025	06	8,90	0,044	12984.9	
-----------	----	------	-------	---------	--

- CONTENTS / CONTENIDO
- 1 - 24000/003 - 3" Vegetable and fruit knife / Cuchillo para legumbres y frutas 3"
  - 1 - 24009/008 - 8" Bread knife / Cuchillo para pan 8"
  - 1 - 24011/008 - 8" Chef's knife / Cuchillo Chef 8"
  - 1 - 24017/010\* - 10" Sharpener / Afilador 10"
  - 1 - 24023/006 - 6" Fillet knife / Cuchillo para filetear 6"
  - 1 - 29900/551 - Nylon case / Estuche de nylon



**20 pcs. Chef's kit / Kit chef 20 pzas.**

24099/027	02	12,07	0,075	12986.3	
-----------	----	-------	-------	---------	--

- CONTENTS / CONTENIDO
- 1 - 24000/003 - 3" Vegetable and fruit knife / Cuchillo legumbres y frutas 3"
  - 1 - 24001/003 - 3" Peeling knife / Cuchillo para tornejar 3"
  - 1 - 24009/008 - 8" Bread knife / Cuchillo para pan 8"
  - 1 - 24011/008 - 8" Chef's knife / Cuchillo Chef 8"
  - 1 - 24014/006 - 6" Cleaver / Hachuela 6"
  - 1 - 24023/006 - 6" Fillet knife / Cuchillo para filetear 6"
  - 1 - 24029/000 - Two-sided whetstone / Piedra para afilar doble faz
  - 1 - 24032/010 - 10" Diamond sharpener / Afilador diamantado 10"
  - 1 - 25330/014 - Strainer / Colador - ø 14 cm
  - 1 - 25682/000 - Silicone pastry brush / Pincel de silicone
  - 1 - 25683/000 - Digital thermometer / Termometro digital
  - 1 - 25684/000 - Oyster knife / Cuchillo para ostra
  - 1 - 25686/000 - Fish bone tweezers / Pinza pescado
  - 1 - 25708/000 - Potato peeler / Pela papas
  - 1 - 25709/000 - Lemon grater / Rallador de limón
  - 1 - 25725/000 - Silicone spatula / Espátula silicone
  - 1 - 25728/035 - Whip / Batidor manual (35 cm)
  - 1 - 25805/000 - Multiuse tong / Pinza multiuso (29 cm)
  - 1 - 25921/000 - 10" Poultry scissor / Tijera trinchante 10"
  - 1 - 29900/500 - Nylon case / Estuche de nylon

\* Without NSF certificate. | No tiene chancela del NSF.



# KNIVES

## CUCHILLOS

### Sushi Diamond

- high-performance stainless steel blades and handles with a special edge for precise cuts | láminas y mangos de acero inoxidable de alto desempeño con filo especial para cortes precisos
- with grooves that ensure a firm grip, the stainless steel handles are easy to clean and very sturdy | con ranuras que garantizan total firmeza durante su uso, los mangos de acero inoxidable son fácil de limpiar y muy resistente



Revised in February 2022  
Revisado en Febrero 2022



watch the video



vea el vídeo



**(9") Yanagiba knife / Cuchillo Yanagiba**

Ref.	un.	Kg	m <sup>3</sup>	789.111.2.	packaging empaque
24240/009	04	1,69	0,005	25954.6	<input type="checkbox"/>



**(13") Yanagiba knife / Cuchillo Yanagiba**

24240/013	04	2,21	0,007	25955.3	<input type="checkbox"/>
-----------	----	------	-------	---------	--------------------------



**(8") Deba knife / Cuchillo Deba**

24241/008	04	2,46	0,007	25956.0	<input type="checkbox"/>
-----------	----	------	-------	---------	--------------------------



**(7") Nakiri knife / Cuchillo Nakiri**

24242/007	04	1,73	0,004	25957.7	<input type="checkbox"/>
-----------	----	------	-------	---------	--------------------------







# KNIVES

# CUCHILLOS

## Sushi Gold

- high-performance stainless steel blades | láminas de acero inoxidable de alto desempeño
- reinforced polycarbonate handles with fiberglass | mangos de policarbonato reforzado con fibra de vidrio



Revised in February 2022  
Revisado en Febrero 2022



**(8") Deba knife / Cuchillo Deba**

Ref.	un.	Kg	m <sup>3</sup>	789.1112.	packaging empaque
24027/008	04	2,11	0,006	24197.8	<input type="checkbox"/>



**(7") Nakiri knife / Cuchillo Nakiri**

24028/007	04	1,36	0,004	24198.5	<input type="checkbox"/>
-----------	----	------	-------	---------	--------------------------



**(9") Yanagiba knife / Cuchillo Yanagiba**

24039/009	04	1,49	0,005	24245.6	<input type="checkbox"/>
-----------	----	------	-------	---------	--------------------------





# KNIVES

## CUCHILLOS

### Sushi Silver

- high-performance stainless steel blades | láminas de acero inoxidable de alto desempeño
- nylon handles | mangos de nylon
- stainless steel tweezer | pinza de acero inoxidable



Revised in February 2022  
Revisado en Febrero 2022



**(9") Yanagiba knife / Cuchillo Yanagiba**

Ref.	un.	Kg	m <sup>3</sup>	789.1112.	packaging empaque
24230/049	04	1,28	0,004	24695.9	<input type="checkbox"/>



**(13") Yanagiba knife / Cuchillo Yanagiba**

24230/043	04	1,98	0,007	24693.5	<input type="checkbox"/>
-----------	----	------	-------	---------	--------------------------



**(8") Deba knife / Cuchillo Deba**

24231/048	04	2,07	0,007	24694.2	<input type="checkbox"/>
-----------	----	------	-------	---------	--------------------------



**(7") Nakiri knife / Cuchillo Nakiri**

24232/047	04	1,37	0,004	24696.6	<input type="checkbox"/>
-----------	----	------	-------	---------	--------------------------



**Tweezer / Pinza (10 cm)**

25687/000*	04	0,33	0,001	24203.6	<input type="checkbox"/>
------------	----	------	-------	---------	--------------------------













# KNIVES

---

# CUCHILLOS

## Cronos

- satin stainless steel blades | láminas de acero inoxidable satinado
- polished stainless steel handles | mangos de acero inoxidable pulido
- dishwasher safe | resistente a lavavajillas

Ref.	un.	Kg	m <sup>3</sup>	789.1112.	packaging empaque	
<b>(3") Vegetable and fruit knife / Cuchillo para legumbres y frutas</b>						
	24070/003*	12	2,14	0,011	09091.0	<input type="checkbox"/>
<b>(5") Steak / fruit knife / Cuchillo asado / frutas</b>						
	24071/005*	12	2,23	0,011	09092.7	<input type="checkbox"/>
<b>(6", 8") Utility knife / Cuchillo utility</b>						
	24072/006*	12	3,32	0,014	09093.4	<input type="checkbox"/>
	008*		3,74	0,017	09094.1	
<b>(8") Chef's knife / Cuchillo Chef</b>						
	24073/008*	12	3,91	0,018	09095.8	<input type="checkbox"/>
<b>(8") Bread knife / Cuchillo pan</b>						
	24074/008*	12	3,52	0,018	09096.5	<input type="checkbox"/>
<b>Carving fork / Tenedor trinchante (34 cm)</b>						
	24077/000*	12	3,88	0,031	16058.3	<input type="checkbox"/>
<b>(8") Sharpener / Afilador</b>						
	24078/008*	12	4,47	0,031	16075.0	<input type="checkbox"/>



**6 pcs. Knives set / Juego cuchillos 6 pzas.**

Ref.	un.	Kg	m <sup>3</sup>	789.1112.	packaging empaque
24099/070*	05	6,62	0,025	09097.2	

**CONTENTS / CONTENIDO**

- 1 - 24070/003 - 3" Vegetable and fruit knife / Cuchillo para legumbres y frutas 3"
- 1 - 24071/005 - 5" Steak / fruits knife / Cuchillo para asado / frutas 5"
- 1 - 24072/006 - 6" Utility knife / Cuchillo Utility 6"
- 1 - 24072/008 - 8" Utility knife / Cuchillo Utility 8"
- 1 - 24073/008 - 8" Chef's knife/ Cuchillo Chef 8"
- 1 - 24074/008 - 8" Bread knife / Cuchillo pan 8"



**3 pcs. Knives set / Juego cuchillos 3 pzas.**

24099/071*	05	3,15	0,020	09619.6	
------------	----	------	-------	---------	--

**CONTENTS / CONTENIDO**

- 1 - 24070/003 - 3" Vegetable and fruit knife / Cuchillo para legumbres y frutas 3"
- 1 - 24072/005 - 5" Utility knife / Cuchillo Utility 5"
- 1 - 24073/008 - 8" Chef's knife/ Cuchillo Chef 8"



**6 pcs. Knives set / Juego cuchillos 6 pzas.**

24099/078*	02	5,74	0,027	26497.7	
------------	----	------	-------	---------	--

**CONTENTS / CONTENIDO**

- 1 - 24070/003 - 3" Vegetable and fruit knife / Cuchillo para legumbres y frutas 3"
- 1 - 24071/005 - 5" Steak / fruits knife / Cuchillo para asado / frutas 5"
- 1 - 24072/006 - 6" Utility knife / Cuchillo Utility 6"
- 1 - 24073/008 - 8" Chef's knife/ Cuchillo Chef 8"
- 1 - 24074/008 - 8" Bread knife / Cuchillo pan 8"
- 1 - 10588/080 - Wooden knife storage / Taco madera





# KNIVES

---

# CUCHILLOS

Certified by NSF International, an internationally recognized organization for the monitoring of food safety and hygiene practices in the food and hospitality sectors.

Certificada por el NSF, National Sanitation Foundation, organización internacionalmente reconocida en monitoreo de seguridad de alimentos y prácticas de higiene en empresas de alimentos y restaurantes.

Special stainless steel blade, heat treated with sub-zero and stress relieving processes, provides a precise, long-lasting cutting edge.

Lámina de acero inoxidable especial, tratada con procesos de templado subcero y revenido, proporcionando un filo más preciso y durable.

Grinding into a V-shape ensures precise cutting and excellent performance even after multiple sharpenings of the blade.

Desbaste en forma "V" asegura un corte preciso y un excelente rendimiento incluso después de varios afilados.

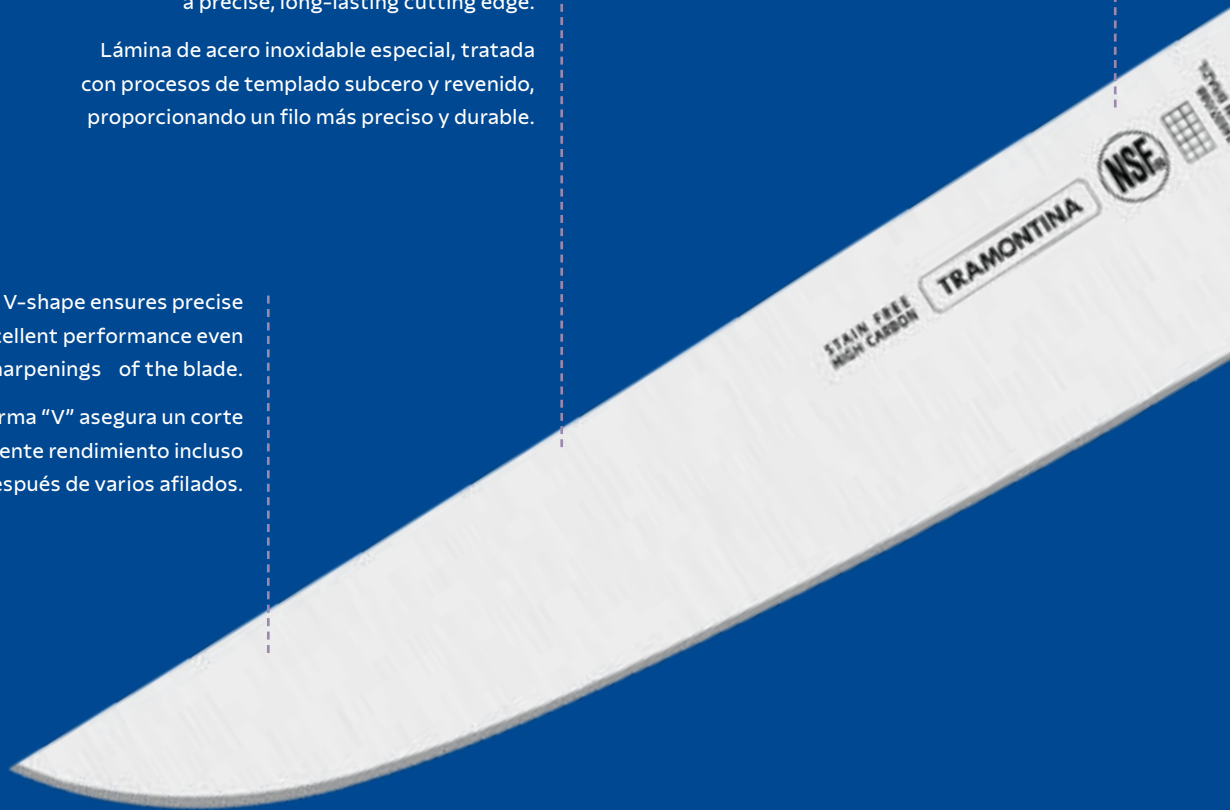

# PROFESSIONAL KNIVES

---

# CUCHILLOS PROFESIONALES



Polypropylene handles with antimicrobial protection.

Mangos de polipropileno con protección antimicrobiana.

There are absolutely no gaps between the parts, so no residues are retained.

Ausencia total de rendijas, evitando holguras o grietas entre las partes y la retención de residuos.



Revised in February 2022  
Revisado en Febrero 2022



# KNIVES CUCHILLOS

## Professional Knives Cuchillos Profesionales



Revised in February 2022  
Revisado en Febrero 2022

### Colors | Colores



black | negro      blue | azul 2935c      green | verde 348c      brown | marrón 476c      yellow | amarillo 116c      red | rojo 1797c      white | blanco

#### (8", 10", 12") Butcher knife / Cuchillo carnicero



Ref.	un.	Kg	m <sup>3</sup>	789.1112.	packaging empaque
<input type="checkbox"/> 24420/088		10,67	0,026	05224.6	
<input type="checkbox"/> 080	60	14,59	0,044	05222.2	
<input type="checkbox"/> 082		16,81	0,055	05223.9	

#### (8", 10", 12") Butcher knife / Cuchillo carnicero



<input type="checkbox"/> 24421/088		10,48	0,026	05230.7	
<input type="checkbox"/> 080	60	14,28	0,044	05228.4	
<input type="checkbox"/> 082		16,36	0,052	05229.1	

#### (10", 12") Impact knife / Cuchillo impacto



<input type="checkbox"/> 24422/080		15,10	0,039	11601.6	
<input type="checkbox"/> 082	60	17,27	0,039	11603.0	



15mm not sharpened blade  
15mm hoja sin filo



#### (5") Boning knife / Cuchillo deshuesar

<input type="checkbox"/> 24511/085	60	7,17	0,018	07257.2	
------------------------------------	----	------	-------	---------	--



#### (5") Poultry knife (double cutting edge) / Cuchillo aves (lámina con doble filo)



<input type="checkbox"/> 24600/085	60	7,23	0,016	05780.7	
------------------------------------	----	------	-------	---------	--

**(4", 5") Poultry boning knife / Cuchillo deshuesar aves**

Ref.	un.	Kg	m <sup>3</sup>	789.1112.	packaging empaque
■ 24601/014				09557.1	
■ 054	60	6,72	0,015	09631.8	
□ 084				09514.4	
■ 015				05238.3	
■ 055		7,29	0,016	05239.0	
□ 085				05240.6	
□ 185				8,96	



**(5", 7") Boning knife / Cuchillo deshuesar**

■ 24602/005				05078.5	
■ 015	60	6,17	0,016	05425.7	
■ 025				06893.3	
■ 055				05426.4	
■ 075				07783.6	
□ 085				05427.1	
■ 007				6,70	
■ 017	08207.6				
■ 027	08208.3				
■ 057	08209.0				
■ 077	18964.5				
□ 087	07878.9				
□ 185	8,12	0,033	05428.8		



**(6", 7") Meat/boning knife / Cuchillo carne/deshuesar**

□ 24603/086	60	5,94	0,014	05246.8			
□ 087				6,76		0,017	05247.5
□ 186				7,86		0,033	05248.2
□ 187				8,60		0,030	05249.9





**(6") Boning knife / Cuchillo deshuesar**

■ 24604/006				05081.5	
■ 016	60	6,46	0,014	05250.5	
■ 026				06894.0	
■ 056				05251.2	
■ 076				08261.8	
□ 086				05252.9	
□ 186				8,39	



**(5", 6", 7") Meat / boning knife / Cuchillo carne / deshuesar**

■ 24605/005				18967.6	
■ 015	60	6,82	0,016	09180.1	
■ 025				09574.8	
■ 055				08361.5	
■ 075				18971.3	
□ 085				07879.6	
■ 006				7,21	
■ 016	05254.3				
■ 026	06965.7				
■ 056	05256.7				
■ 076	07784.3				
□ 086	05258.1				
■ 007	7,75	0,017	05083.9		
■ 017			05255.0		
■ 027			08514.5		
■ 057			05257.4		
■ 077			18972.0		
□ 087			05259.8		
□ 186	9,12	0,032	05260.4		
□ 187	10,04	0,030	05261.1		





**(6", 7") Skinning knife / Cuchillo despellejar**



Ref.	un.	Kg	m <sup>3</sup>	789.1112.	packaging empaque
■ 24606/006				05084.6	
■ 016				05262.8	
■ 026		7,94	0,022	07105.6	
■ 056				05263.5	
■ 076				08247.2	
□ 086	60			05264.2	
■ 007				18973.7	
■ 017				05782.1	
■ 027		8,85	0,021	07982.3	
■ 057				05783.8	
■ 077				08248.9	
□ 087				05784.5	





**(6") Meat knife / Cuchillo para carne**

■ 24607/006				05085.3		
■ 016				05268.0		
■ 056	60	8,64	0,022	05273.4		
■ 076				12093.8		
□ 086				05278.9		
□ 186		11,03	0,046	05281.9		



**(7", 8", 10", 12") Meat knife / Cuchillo para carne**



■ 24607/007				15965.5	
■ 017				05269.7	
■ 057		9,57	0,025	05274.1	
■ 077				12095.2	
□ 087				05279.6	
■ 008				05086.0	
■ 018				05270.3	
■ 058		10,84	0,027	05275.8	
■ 078				08267.0	
□ 088				05280.2	
■ 000				18975.1	
■ 010	60	12,50	0,029	05266.6	
■ 050				05271.0	
■ 070				08265.6	
□ 080				05276.5	
■ 002				18976.8	
■ 012				05267.3	
■ 052		14,38	0,033	05272.7	
■ 072				08266.3	
□ 082				05277.2	
□ 187		11,88	0,047	05450.9	
□ 188		13,57	0,045	05282.6	
□ 180		15,57	0,064	05448.6	
□ 182		17,03	0,064	05449.3	

**(6", 8", 10", 12") Meat knife / Cuchillo para carne**



■ 24608/056		8,68	0,022	05288.8		
□ 086				05292.5		
■ 058		9,80	0,023	05289.5		
□ 088				05293.2		
■ 050	60	12,74	0,029	05286.4		
□ 080				05290.1		
■ 052		14,08	0,034	05287.1		
□ 082				05291.8		
□ 186		11,13	0,046	05296.3		



**(6", 8", 10", 12", 14") Meat knife / Cuchillo para carne**



Ref.	un.	Kg	m³	789.1112.	packaging empaque
■ 24609/006				15964.8	
■ 016				05786.9	
■ 026		8,68	0,023	08268.7	
■ 056				05787.6	
■ 076				08249.6	
□ 086				05788.3	
■ 008				05089.1	
■ 018				05298.7	
■ 028		10,74	0,023	07980.9	
■ 058				05301.4	
■ 078				07785.0	
□ 088				05304.5	
■ 000				15957.0	
■ 010				05090.7	
■ 020		13,16	0,031	07755.3	
■ 050				05299.4	
■ 070				07757.7	
□ 080	60			05302.1	
■ 002				15958.7	
■ 012				05297.0	
■ 022		16,35	0,042	07756.0	
■ 052				05300.7	
■ 072				07758.4	
□ 082				05303.8	
■ 004				19349.9	
■ 014				19353.6	
■ 024		19,95	0,039	19354.3	
■ 054				19356.7	
■ 074				19357.4	
□ 084				06801.8	
□ 188		13,21	0,048	05306.9	
□ 180		16,27	0,064	05305.2	1
□ 182		19,20	0,064	05452.3	

**(6", 8", 10", 12", 14") Skinning knife / Cuchillo despellejar**



■ 24610/016				05308.3	
■ 056		8,20	0,022	05312.0	
■ 076				08252.6	
□ 086				05316.8	
■ 018				05309.0	
■ 058		10,05	0,021	05313.7	
■ 078				07760.7	
□ 088	60			05317.5	
■ 010				05307.6	
■ 050		11,31	0,029	05310.6	
■ 070				08250.2	
□ 080				05314.4	
□ 082		13,00	0,033	05315.1	
□ 084		15,06	0,039	05791.3	
□ 186		10,11	0,034	05320.5	
□ 188		12,92	0,046	05321.2	1

**(8", 10", 12") Meat knife / Cuchillo para carne**



■ 24611/058				07949.6	
□ 088		10,42	0,024	07880.2	
□ 080	60	12,66	0,030	05325.0	
□ 082		14,96	0,044	05326.7	



**(4") Boning knife / Cuchillo deshuesar**

Ref.	un.	Kg	m <sup>3</sup>	789.1112.	packaging empaque
■ 24612/054	60	6,06	0,015	05793.7	
□ 084				05794.4	



**(4") Turkey drummette and jowl knife /  
Cuchillo para entrealas y papada del pavo**

■ 24613/054	60	5,93	0,016	07212.1	
□ 084				07213.8	



**(5") Poultry wing cutting knife / Cuchillo para cortar alas**

■ 24614/015				07374.6	
■ 055	60	6,30	0,016	07214.5	
□ 085				07218.3	



**(5") Poultry "oyster" cutting knife /  
Cuchillo para extracción de la cola de aves**

■ 24615/055	60	6,19	0,014	07260.2	
□ 085				07364.7	



**(5") Pork leg boning knife /  
Cuchillo para deshuesar pata de cerdo**



□ 24616/085	60	9,09	0,025	07217.6	
-------------	----	------	-------	---------	--



**(6", 8", 10") Meat knife / Cuchillo para carne**

■ 24619/016				10467.9	
■ 026				12806.4	
■ 056		5,38	0,010	08233.5	
□ 086				07881.9	
■ 018				07378.4	
■ 028	60	8,50	0,017	12809.5	
■ 058				07366.1	
□ 088				07262.6	
■ 010				07377.7	
■ 020				12812.5	
■ 050		11,30	0,021	07365.4	
□ 080				07261.9	

**(6", 8", 10") Meat / boning knife /  
Cuchillo para carne / deshuesar**

Ref.	un.	Kg	m <sup>3</sup>	789.1112.	packaging empaque
■ 24620/006				13361.7	
■ 016				05629.9	
■ 026				07216.9	
■ 046		5,06	0,009	07944.1	
■ 056				05556.8	
■ 076				07947.2	
□ 086				05329.8	
■ 008				13769.1	
■ 018				05630.5	
■ 028				07942.7	
■ 048		8,75	0,018	07945.8	
■ 058				05558.2	
■ 078				07948.9	
□ 088				05330.4	
■ 000				13357.0	
■ 010				05628.2	
■ 020				07941.0	
■ 040		12,60	0,028	07943.4	
■ 050				05555.1	
■ 070				07946.5	
□ 080				05328.1	
■ 106	60			13362.4	
■ 116				06732.5	
■ 126				09746.9	
■ 146		6,84	0,024	09747.6	
■ 156				06735.6	
■ 176				09748.3	
□ 186				05332.8	
■ 108				13770.7	
■ 118				06733.2	
■ 128				09749.0	
■ 148		10,60	0,030	09750.6	
■ 158				06736.3	
■ 178				09751.3	
□ 188				05333.5	
■ 100				13358.7	
■ 110				06731.8	
■ 120				09743.8	
■ 140		16,00	0,064	09744.5	
■ 150				06734.9	
■ 170				09745.2	
□ 180				05331.1	



**(8") Fillet knife / Cuchillo filetear**

□ 24622/088	60	6,98	0,020	05347.2	
-------------	----	------	-------	---------	---





**(14") Butcher knife / Cuchillo carnicero**

□ 24623/084	60	12,73	0,039	05349.6	
-------------	----	-------	-------	---------	---



**(6", 7", 8", 9", 10", 11", 12") Butcher knife / Cuchillo carnicero**



Ref.	un.	Kg	m <sup>3</sup>	789.1112.	packaging empaque
■ 24621/006				19035.1	
■ 016				05634.3	
■ 026				06895.7	
■ 056	7,63	0,022		05562.9	
■ 076				19055.9	
□ 086				05336.6	
■ 007				19036.8	
■ 017				05635.0	
■ 027	8,66	0,023		19042.9	
■ 057				05563.6	
■ 077				19056.6	
□ 087				05337.3	
■ 008				19037.5	
■ 018				05636.7	
■ 028	10,84	0,023		06963.3	
■ 058				05564.3	
■ 078				19057.3	
□ 088				05338.0	
□ 089	11,98	0,026		05339.7	
■ 000				19032.0	
■ 010				05631.2	
■ 020	13,78	0,031		19039.9	
■ 050				05559.9	
■ 070				19051.1	
□ 080				05334.2	
□ 081	16,94	0,054		05335.9	
■ 002				19034.4	
■ 012				05633.6	
■ 022	20,79	0,055		19041.2	
■ 052				05561.2	
■ 072				19054.2	
□ 082				05431.8	
□ 186	9,40	0,041		05342.7	
□ 187	10,30	0,041		05343.4	
□ 188	13,36	0,060		05344.1	
□ 189	15,01	0,060		05345.8	
□ 180	16,81	0,064		05340.3	





**(6") Cleaver / Hachuela**

■ 24624/116				06740.0	
■ 156	12	5,46	0,015	06741.7	
□ 186				05351.9	

**(3", 4") Paring knife / Cuchillo mondador**



□ 24625/083	120	4,68	0,008	05352.6	
□ 084		4,83	0,010	05353.3	
□ 183	60	3,42	0,021	05354.0	
□ 184		3,50	0,021	05355.7	

**(3") Paring knife / Cuchillo mondador**



Ref.	un.	Kg	m³	789.1112.	packaging empaque
<input type="checkbox"/> 24626/083	120	4,62	0,010	05356.4	
<input type="checkbox"/> 183	60	3,65	0,021	05357.1	<input type="checkbox"/> 1

**(8", 10", 12") Ham / bread slicer / Cuchillo fiambre / pan**



<input type="checkbox"/> 24627/088		8,23	0,021	05360.1	
<input type="checkbox"/> 080		8,90	0,021	05358.8	
<input type="checkbox"/> 082	60	10,06	0,033	05359.5	
<input type="checkbox"/> 188		11,32	0,042	05455.4	
<input type="checkbox"/> 180		11,82	0,042	05456.1	<input type="checkbox"/> 1
<input type="checkbox"/> 182		12,77	0,042	05457.8	

**(12", 14", 16") Ham slicer plain edge / Cuchillo jamón sin sierra**



<input type="checkbox"/> 24628/082		10,02	0,034	05361.8	
<input type="checkbox"/> 084	60	10,77	0,039	09327.0	
<input type="checkbox"/> 086		10,77	0,033	11526.2	

**(5", 6") Boning knife / Cuchillo deshuesar**



<input checked="" type="checkbox"/> 24635/055	60	6,64	0,023	08573.2	
<input type="checkbox"/> 085				08446.9	
<input checked="" type="checkbox"/> 056		6,40	0,015	05363.2	
<input type="checkbox"/> 086				05364.9	

**(6") Boning knife / Cuchillo deshuesar**



<input checked="" type="checkbox"/> 24636/056	60	6,93	0,015	05367.0	
<input checked="" type="checkbox"/> 076				15963.1	
<input type="checkbox"/> 086				05368.7	

**(6") Meat knife / Cuchillo para carne**



<input type="checkbox"/> 24637/086	60	9,13	0,022	05372.4	
<input type="checkbox"/> 186		11,74	0,045	05373.1	<input type="checkbox"/> 1

**(6") Boning Knife / Cuchillo deshuesar**



<input checked="" type="checkbox"/> 24638/056	60	6,35	0,015	07883.3	
<input type="checkbox"/> 086				07884.0	





**(7") Cook's knife / Cuchillo carnicero**

Ref.	un.	Kg	m <sup>3</sup>	789.1112.	packaging empaque
<input type="checkbox"/> 24646/087	60	11,12	0,024	08212.0	



**(5") Fillet knife / Cuchillo filetear**

<input type="checkbox"/> 24651/085	60	9,81	0,024	09528.1	
------------------------------------	----	------	-------	---------	--



**(5") Boning Knife / Cuchillo deshuesar**

<input checked="" type="checkbox"/> 24652/055	60	6,02	0,016	07367.8	
<input type="checkbox"/> 085				07263.3	



**(6") Boning Knife / Cuchillo deshuesar**

<input type="checkbox"/> 24653/086	60	5,86	0,015	07264.0	
------------------------------------	----	------	-------	---------	--



**(6") Boning Knife / Cuchillo deshuesar**

<input checked="" type="checkbox"/> 24655/056	60	6,80	0,014	07369.2	
<input type="checkbox"/> 086				07265.7	



**(6") Boning knife / Cuchillo deshuesar**

<input checked="" type="checkbox"/> 24660/016	60	8,36	0,023	08506.0	
<input checked="" type="checkbox"/> 056				08507.7	
<input type="checkbox"/> 086				08439.1	



**(6") Boning knife / Cuchillo deshuesar**

<input checked="" type="checkbox"/> 24661/056	60	7,71	0,022	08509.1	
<input type="checkbox"/> 086				08440.7	



**(5", 6") Boning knife / Cuchillo deshuesar**

<input checked="" type="checkbox"/> 24662/055	60	7,53	0,023	08511.4	
<input type="checkbox"/> 085				08441.4	
<input checked="" type="checkbox"/> 056		7,87	0,022	09569.4	
<input type="checkbox"/> 086				09515.1	



**(6") Boning knife / Cuchillo deshuesar**

Ref.	un.	Kg	m <sup>3</sup>	789.1112.	packaging empaque
■ 24663/016				08512.1	
■ 056	60	9,26	0,023	08513.8	
□ 086				08442.1	



**(8", 10", 12") Meat knife / Cuchillo para carne**

□ 24664/088		10,78	0,026	08954.9	
□ 080	60	12,31	0,030	08957.0	
□ 082		13,88	0,032	08960.0	



**(5") Poultry boning knife / Cuchillo de desosado**

□ 24667/085	60	7,14	0,016	14393.7	
-------------	----	------	-------	---------	---

**8" Dismantable shears  
Tijera desmontable 8"**



Smooth edge  
Filo liso



Micro-serrated  
Filo microdentado



Dismantable shears  
Tijera Desmontable

**Plain edge - Filo liso**

□ 25923/088	48	4,50	0,014	12034.1	
-------------	----	------	-------	---------	---

**Micro-serrated - Filo microdentado**

□ 25924/088	48	4,50	0,014	12035.8	
-------------	----	------	-------	---------	---



**Knife's edge aligner / Alineador de filo de cuchillos**

■ 24644/050	06	2,22	0,022	22425.4	
□ 080				22426.1	



**Knife's edge aligner / Alineador de filo de cuchillos**

□ 24690/000	06	2,28	0,014	22644.9	
-------------	----	------	-------	---------	---

\* Without NSF certificate. | No tiene chancela del NSF.

----- Exclusive material for legal entities/corporate clients. | Material exclusivo para clientes persona jurídica. -----



**(10") Grooved sharpener / Afilador estriado**  
Steel SAE 6150 or 9254 / Acero SAE 6150 o 9254

Ref.	un.	Kg	m <sup>3</sup>	789.1112.	packaging empaque
<input type="checkbox"/> 24640/080*	60	15,34	0,041	05374.8	
<input type="checkbox"/> 180*		18,12	0,078	05375.5	



**(8") Grooved sharpener / Afilador estriado**  
Steel SAE 1045 / Acero SAE 1045

<input type="checkbox"/> 24641/088	60	12,40	0,041	05376.2	
<input type="checkbox"/> 188		14,41	0,076	05377.9	



**(10", 12", 14") Grooved sharpener / Afilador estriado**  
Steel SAE 1045 / Acero SAE 1045

<input checked="" type="checkbox"/> 24642/050*	60	15,98	0,041	06604.5	
<input type="checkbox"/> 080*				05379.3	
<input checked="" type="checkbox"/> 052*		21,52	0,058	06605.2	
<input type="checkbox"/> 082*				05380.9	
<input checked="" type="checkbox"/> 054*		23,58	0,073	12741.8	
<input type="checkbox"/> 084*				05381.6	
<input type="checkbox"/> 180*		18,02	0,078	05382.3	
<input type="checkbox"/> 182*				05383.0	



**(10", 12") Smooth sharpener / Afilador liso**  
Steel SAE 1045 / Acero SAE 1045

<input checked="" type="checkbox"/> 24643/050*	60	15,04	0,041	06612.0	
<input type="checkbox"/> 080*				05385.4	
<input checked="" type="checkbox"/> 052*		21,20	0,056	06613.7	
<input type="checkbox"/> 082*				05386.1	



**6 pc. Cutlery set / Juego de cuchillos 6 pzas.**

24699/816	06	7,97	0,044	12987.0	
-----------	----	------	-------	---------	--

**CONTENTS / CONTENIDO**

- 1 - 24603/086 - 6" Meat / boning knife / Cuchillo carne / deshuesar 6"
- 1 - 24619/088 - 8" Meat knife / Cuchillo carne 8"
- 1 - 24626/083 - 3" Paring knife / Cuchillo mondador 3"
- 1 - 24627/088 - 8" Ham / bread slicer / Cuchillo fiambre / pan 8"
- 1 - 24640/080\* - 10" Grooved sharpener / Afilador estriado 10"
- 1 - 29900/559 - Nylon case / Estuche de nylon

\* Without NSF certificate. | No tiene chancela del NSF.



# KNIVES

# CUCHILLOS

## Profio

Dull knives not only make a chef's job more difficult, but they also compromise the dish's appearance. With this essential kitchen item in mind, Tramontina has developed the Profio line, with eight distinct pieces | Los cuchillos desafilados no solamente le dificultan el trabajo a los gourmets sino que pueden comprometer la terminación visual de una receta. Pensando en ese elemento fundamental del equipamiento de los cocineros, Tramontina desarrolló la línea Profio, con ocho piezas diferentes.



### Whetstone / Piedra de afilar

Ref.	un.	Kg	m <sup>3</sup>	789.1112.	packaging empaque
24036/000*	04	1,48	0,002	27790.8	<input type="checkbox"/>



### Two-sided whetstone / Piedra para afilar doble faz

24029/000*	06	4,35	0,005	12190.4	<input type="checkbox"/>
------------	----	------	-------	---------	--------------------------



### Whetstone / Piedra de afilar

24033/000*	04	4,34	0,005	24320.0	<input type="checkbox"/>
------------	----	------	-------	---------	--------------------------



### Whetstone / Piedra de afilar

24034/000*	04	4,34	0,005	24321.7	<input type="checkbox"/>
------------	----	------	-------	---------	--------------------------



### Two-sided diamond sharpener / Afilador doble faz diamantado

24030/000*	06	2,24	0,007	12559.9	<input type="checkbox"/>
------------	----	------	-------	---------	--------------------------



### Diamond knife sharpener / Afilador de cuchillos diamantado

24031/000*	06	1,62	0,009	12560.5	<input type="checkbox"/>
------------	----	------	-------	---------	--------------------------



### (10'') Diamond sharpener / Afilador diamantado

24032/010*	06	1,89	0,012	12558.2	<input type="checkbox"/>
------------	----	------	-------	---------	--------------------------



### Knife sharpening angle gride / Guia para afilar cuchillos

24035/000*	12	0,66	0,006	24322.4	<input type="checkbox"/>
------------	----	------	-------	---------	--------------------------



# KNIVES CUCHILLOS

## Pocket knives | Navajas

- stainless steel blades | láminas de acero inoxidable
- handles made of abs or wood | mangos de abs o madera



**(3") Pocketknife - ABS handle / Navaja - mango ABS**

Ref.	un.	Kg	m <sup>3</sup>	789.1112.	packaging empaque
26300/003	240	19,87	0,041	01484.8	6



**(3") Pocketknife - ABS handle / Navaja - mango ABS**

26301/003	240	24,53	0,047	01485.5	6
-----------	-----	-------	-------	---------	---



**(3") Pocketknife - wooden handle / Navaja - mango madera**

26325/103	48	7,13	0,040	00412.2	1
-----------	----	------	-------	---------	---

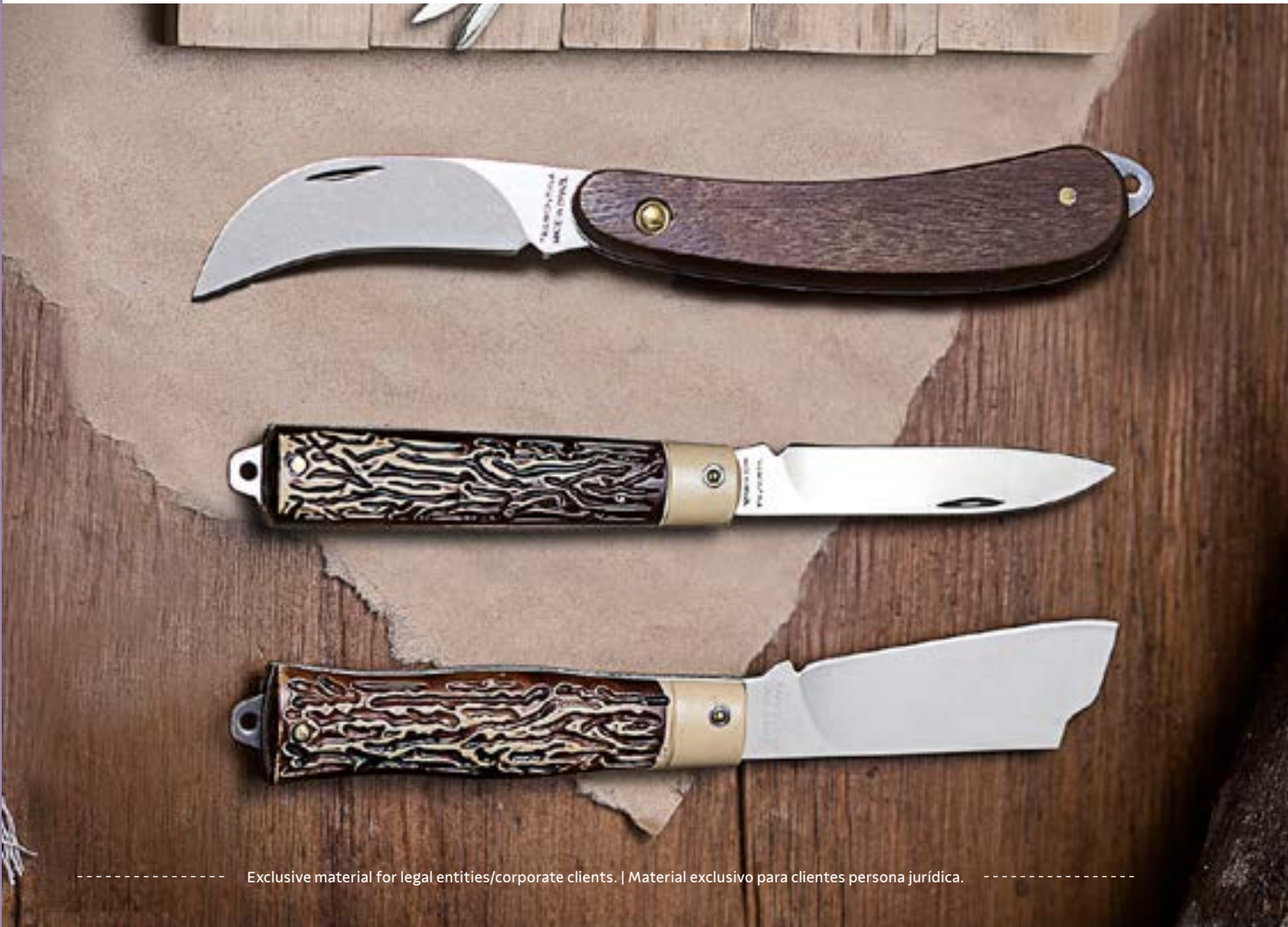





## KNIVES

## CUCHILLOS

## Sports knives | Cuchillos Deportivos

- stainless steel blades | láminas de acero inoxidable
- handles of abs, polypropylene or rubber | mangos de abs, polipropileno o revestidos de goma
- different types: Outdoor, Sport, Fish and Campera | conceptos: Outdoor, Sport, Fish y Campera
- includes a waterproof nylon sheath, synthetic, leather or polypropylene finish | viene con vaina de nylon impermeable, material sintético, cuero o de polipropileno

### Outdoor



**(5") Hunting knife / Cuchillo deportivo**  
ABS handle, synthetic material sheath /  
Mango ABS, vaina material sintético

Ref.	un.	Kg	m <sup>3</sup>	789.1112.	packaging empaques
26010/105	12	2,82	0,012	00120.6	1



**(6") Hunting knife / Cuchillo deportivo**  
ABS handle, synthetic material sheath /  
Mango ABS, vaina material sintético

26010/106	12	3,31	0,018	00121.3	1
-----------	----	------	-------	---------	---



**(5") Hunting knife / Cuchillo deportivo**  
ABS handle, synthetic material sheath /  
Mango ABS, vaina material sintético

26011/105	12	2,76	0,012	00185.5	1
-----------	----	------	-------	---------	---

### Sport



**(6") Hunting knife / Cuchillo deportivo**  
Polypropylene handle, waterproof nylon sheath with  
rubberized finish and cord / Mango polipropileno, vaina  
de nylon impermeable con acabado engomado y cordón

26003/106	12	2,38	0,014	00513.6	1
-----------	----	------	-------	---------	---

## Fish



### (5") Bowie knife / Cuchillo deportivo

Rubber handle, synthetic sheath / Mango goma, vaina sintético

Ref.	un.	Kg	m <sup>3</sup>	789.1112.	packaging empaque
26051/105	12	2,46	0,014	00083.4	1



### (6") Fillet knife / Cuchillo filetear

Polypropylene handle, polypropylene sheath with sharpener / Mango polipropileno, vaina polipropileno con afilador

26053/106	12	2,05	0,017	00199.2	1
-----------	----	------	-------	---------	---

## Campeira



### (8") Campeira knife / Cuchillo Gaucho

Wooden handle, leather sheath / Mango de madeira, vaina de cuero

26081/108	06	2,76	0,018	00183.1	☐
-----------	----	------	-------	---------	---



### 2 pcs. Campeira set / Juego de cuchillos Gaucho 2 pzas.

Wooden handles, leather sheath / Mangos de madeira, vaina de cuero

26099/081	06	4,21	0,023	07807.9	☐
-----------	----	------	-------	---------	---

#### CONTENTS / CONTENIDO

- 1 - 26081/008 - 8" Gaucho knife / Cuchillo Gaucho 8"
- 1 - 26082/008 - 8" Sharpener / Afilador 8"





# UTENSILS

# UTENSILIOS

**WITH SO MANY DIFFERENT STYLES TO CHOOSE FROM, IT COULD ONLY BE A COMPLETE LINE. | CON TANTOS ESTILOS DIFERENTES PARA ELEGIR, SOLO PUEDE SER UNA LÍNEA COMPLETA.**

**140. Polywood**

**142. Professional |  
Profesionales**

**145. Moldê**

**147. Live**

**148. Verano**

**153. Fluence**

**155. Utilità**

**161. Ability**

**164. Movin**

**166. Apreciatta**

**167. Lyon**

After choosing the cutlery for the kitchen, the next stage is to decide if the Tramontina utensils will match your chosen flatware set or will innovate by having a unique style. Following a pattern or being eclectic varies from consumer to consumer, which is why Tramontina has a complete line of utensils to suit all tastes.

Después de elegir los cubiertos para la cocina, la próxima etapa es decidir si los Utensilios Tramontina combinarán con el juego de cubiertos elegido o innovarán al tener un estilo diferente. Seguir un estándar o ser ecléctico varía entre los consumidores, y es por ese motivo que Tramontina cuenta con una línea completa de utensilios para satisfacer todos los gustos.









# UTENSILS UTENSILIOS

## Polywood



Dishwasher safe  
Resistente al lavavajillas



5 years warranty  
5 años de garantía



Impact-resistant  
Resistente a impactos



High temperature resistant  
Resistente a altas temperaturas



Cured wood  
Madera Tratada



watch the video



vea el vídeo

### Colors | Colores



red | rojo



brown | castaño



#### Sauce and pancake handle / Cucharón para salsa y panqueque

Ref.	un.	Kg	m <sup>3</sup>	789.1112.	packaging empaque
■ 21152/170	60	4,91	0,031	01229.5	▲
■ 190				10858.5	



#### Carving fork / Tenedor trinchante (33 cm)

■ 21154/170	36	3,81	0,017	00454.2	▲
■ 190				10859.2	



#### Spatula / Espátula

■ 21155/170	36	4,76	0,021	00455.9	▲
■ 190				10860.8	



#### Skimmer / Espumadera

■ 21156/170	36	4,94	0,030	00456.6	▲
■ 190				10861.5	



#### Ladle / Cucharón

■ 21157/170	36	5,71	0,031	00457.3	▲
■ 190				10862.2	

**Serving spoon / Cuchara para servir**

Ref.	un.	Kg	m <sup>3</sup>	789.1112.	packaging empaque
■ 21158/170	36	4,46	0,018	00458.0	▲
■ 190				10863.9	

**Potato masher / Pisapapas**

■ 21159/170	36	5,42	0,029	02041.2	▲
■ 190				10864.6	

**(8") Baker's spatula / Espátula para repostería**

■ 21161/178	60	7,42	0,026	02417.5	▲
■ 198				10850.9	

**(7") Baker's spatula / Espátula para repostería**

■ 21162/177	60	7,58	0,041	02418.2	▲
■ 197				10532.4	

**(5") Cake spatula / Espátula para pastel**

■ 21163/175	60	7,32	0,036	02419.9	▲
■ 195				10851.6	

**(5") Bench scraper / Espátula raspadora**

■ 21164/175	60	7,47	0,025	02420.5	▲
■ 195				10852.3	

**(4") Turner spatula / Espátula para fritura**

■ 21165/174	60	8,10	0,034	02421.2	▲
■ 194				10534.8	

**(5") Bench scraper / Espátula raspadora**

■ 21166/175	60	10,34	0,025	02422.9	▲
■ 195				10853.0	

**(5") Turner spatula / Espátula para fritura**

■ 21168/175	60	12,53	0,039	11162.2	▲
■ 195				11163.9	



# UTEN SILS

---

# UTEN SILIOS

## Professional | Profesionales

- stainless steel blades | láminas de acero inoxidable
- polypropylene handles | mangos de polipropileno
- dishwasher safe | resistente a lavavajillas



Revised in February 2022  
Revisado en Febrero 2022

### (4" x 1 1/4") Butter spreader / Espátula para mantequilla



Ref.	un.	Kg	m <sup>3</sup>	789.1112.	packaging empaque
<input type="checkbox"/> 24670/184	60	3,96	0,025	05392.2	▲

### (6", 8", 10", 12", 14") Baker's spatula / Espátula para repostería



<input type="checkbox"/> 24671/186		7,16	0,028	05401.1	
<input type="checkbox"/> 188		7,82	0,028	05402.8	
<input type="checkbox"/> 180	60	8,36	0,039	05398.4	▲
<input type="checkbox"/> 182		10,13	0,038	05399.1	
<input type="checkbox"/> 184		11,95	0,042	05400.4	

### (5" x 4") Hamburger spatula / Espátula para hamburguesa



<input type="checkbox"/> 24672/185	60	10,02	0,028	05404.2	▲
------------------------------------	----	-------	-------	---------	---

### (6" x 2 1/4") Cake and pie server / Espátula para torta



<input type="checkbox"/> 24673/186	60	7,93	0,046	05407.3	▲
------------------------------------	----	------	-------	---------	---

### (5" x 2 1/2") Food turner / Espátula para fritura



<input type="checkbox"/> 24674/185	60	9,93	0,056	05410.3	▲
------------------------------------	----	------	-------	---------	---

### (6" x 3 1/2") Food turner / Espátula para fritura



<input type="checkbox"/> 24675/186	60	12,64	0,064	05412.7	▲
------------------------------------	----	-------	-------	---------	---

### (6" x 3") Food turner / Espátula para fritura



<input type="checkbox"/> 24676/186	60	14,14	0,076	05414.1	▲
------------------------------------	----	-------	-------	---------	---



**(7" x 4 1/4") Food turner / Espátula para fritura**

Ref.	un.	Kg	m <sup>3</sup>	789.1112.	packaging empaque
□ 24677/187	60	20,14	0,091	05416.5	▲



**(8" x 3") Food turner / Espátula para fritura**

□ 24678/188	60	12,28	0,074	05418.9	▲
-------------	----	-------	-------	---------	---



**(9" x 3") Food turner / Espátula para fritura**

□ 24679/189	60	13,44	0,076	05420.2	▲
-------------	----	-------	-------	---------	---



**(9" x 3") Food turner / Espátula para fritura**

□ 24680/189	60	13,32	0,076	05422.6	▲
-------------	----	-------	-------	---------	---



**(10", 12") Baker's spatula / Espátula**

□ 24681/180	60	9,36	0,058	08472.8	▲
□ 182		10,61	0,074	08473.5	



**(4") Hamburger spatula / Espátula para hamburguesa**

□ 24479/184	60	6,64	0,027	26392.5	▲
-------------	----	------	-------	---------	---



**Pizza cutter / Cortador de pizza**

□ 24686/180	60	13,50	0,075	05424.0	▲
-------------	----	-------	-------	---------	---



**(4" x 6") Multi-purpose scraper and chopper / Raspador y cortador**

□ 24687/080	60	12,11	0,026	05429.5	●
-------------	----	-------	-------	---------	---



NEW | NUEVO



**Butcher boning hook / Gancho para deshuesar**

Ref.	un.	Kg	m <sup>3</sup>	789.1112.	packaging empaque
24693/080	60	7,09	0,035	31282.1	●

NEW | NUEVO

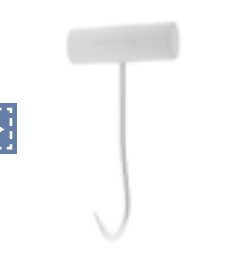

**Butcher boning hook / Gancho para deshuesar**

24693/081	60	7,09	0,035	31283.8	●
-----------	----	------	-------	---------	---



NEW | NUEVO



**Butcher boning hook / Gancho para deshuesar**

24693/082	60	7,09	0,035	31284.5	●
-----------	----	------	-------	---------	---







UTEN  
SILS

UTEN  
SILIOS

Moldê

- silicone utensils | utensilios de silicone
- dishwasher safe | resistente a lavavajillas



watch the video



vea el vídeo



**Spatula / Espátula (30 cm)**

Ref.	un.	Kg	m³	789.1112.	packaging empaque
25810/160*	12	1,50	0,007	29890.3	▲



**Serving spoon / Cuchara para servir (28 cm)**

25811/160*	12	1,49	0,007	29891.0	▲
------------	----	------	-------	---------	---



**Serving spoon / Cuchara para servir (28 cm)**

25812/160*	12	1,49	0,007	29892.7	▲
------------	----	------	-------	---------	---



**Ladle / Cucharón (30 cm)**

25813/160*	12	1,79	0,010	29893.4	▲
------------	----	------	-------	---------	---



**Spatula / Espátula (29 cm)**

25814/160*	12	1,20	0,004	29894.1	▲
------------	----	------	-------	---------	---



**Spatula / Espátula (26 cm)**

25815/160*	12	0,60	0,002	29895.8	▲
------------	----	------	-------	---------	---



**Spatula / Espátula (24,5 cm)**

25816/160*	12	1,08	0,004	29896.5	▲
------------	----	------	-------	---------	---



NEW | NUEVO

**Spatula / Espátula (26 cm)**

Ref.	un.	Kg	m³	789.1112	packaging empaque
25816/161*	12	0,77	0,002	29897.2	▲



NEW | NUEVO

**Multipurpose tong / Pinza multiuso (29 cm)**

25817/160*	12	2,03	0,007	29898.9	▲
------------	----	------	-------	---------	---



NEW | NUEVO

**Multipurpose tong / Pinza multiuso (35 cm)**

25817/161*	12	2,43	0,008	29899.6	▲
------------	----	------	-------	---------	---



NEW | NUEVO

**Basting brush / Pincel (27 cm)**

25818/160*	12	1,37	0,004	29900.9	▲
------------	----	------	-------	---------	---



NEW | NUEVO

**Whisk / Batidor manual (31 cm)**

25819/160*	12	0,82	0,010	29901.6	▲
------------	----	------	-------	---------	---





# UTEN SILS UTEN SILIOS

## Live

- silicone utensils | utensilios de silicone
- wooden handles | mangos de madera
- heat resistant up to 210 °C (410 °F) | resistente hasta 210°C

### Colors | Colores



green | verde  
7734c



grey | gris  
409c



#### Spatula / Espátula

Ref.	un.	Kg	m <sup>3</sup>	789.1112.	packaging empaque
■ 25731/120*	06	0,83	0,010	27870.7	▲
■ 160*				27871.4	



#### Ladle / Cucharón

■ 25732/120*	06	1,12	0,015	27872.1	▲
■ 160*				27873.8	



#### Serving spoon / Cuchara para servir

■ 25733/120*	06	1,00	0,008	27874.5	▲
■ 160*				27875.2	



#### Spaguetti server / Servidor de pasta

■ 25734/120*	06	0,91	0,011	27876.9	▲
■ 160*				27877.6	



#### Spatula / Espátula

■ 25735/120*	06	0,92	0,008	27883.7	▲
■ 160*				27884.4	



# UTEN SILS

---

# UTEN SIlios

## Verano

- nylon utensils | utensilios de nylon
- polypropylene handles | mangos de polipropileno
- dishwasher safe | resistente a lavavajillas



watch the video



vea el vídeo

### Colors | Colores



grey / grey  
gris / gris  
cool gray 5c / 424c



onyx / grey  
onix / gris  
432c / 424c



red / grey  
rojo / gris  
187c / 424c



### Spatula / Espátula

Ref.	un.	Kg	m <sup>3</sup>	789.1112.	packaging empaque
■ 25570/130				26268.3	
■ 160	12	1,35	0,009	26269.0	▲
■ 170				26270.6	



### Serving spoon / Cuchara para servir

■ 25571/130				26271.3	
■ 160	12	1,40	0,009	26272.0	▲
■ 170				26273.7	





### Ladle / Cucharón

Ref.	un.	Kg	m <sup>3</sup>	789.1112.	packaging empaque
■ 25572/130				26274.4	
■ 160	12	1,72	0,014	26275.1	▲
■ 170				26276.8	



### Skimmer / Espumadera

■ 25573/130				26277.5	
■ 160	12	1,44	0,009	26278.2	▲
■ 170				26279.9	



### Spaghetti server / Servidor de pasta

■ 25574/130				26280.5	
■ 160	12	1,25	0,009	26281.2	▲
■ 170				26282.9	

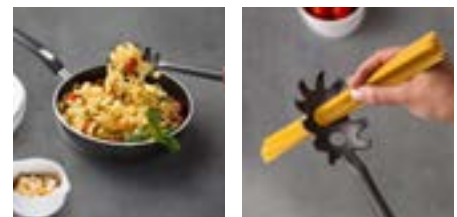

### Spatula / Espátula

■ 25575/130				26283.6	
■ 160	12	1,44	0,007	26285.0	▲
■ 170				26284.3	



### Cake server / Espátula para pastel

■ 25576/130				26286.7	
■ 160	12	1,60	0,010	26287.4	▲
■ 170				26288.1	







**Carving fork / Tenedor trinchante**

Ref.	un.	Kg	m <sup>3</sup>	789.1112.	packaging empaque
■ 25577/130				26289.8	
■ 160	12	1,21	0,009	26344.4	▲
■ 170				26345.1	

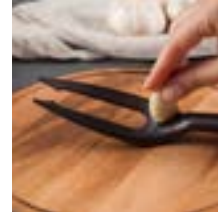

**Multiuse tong / Pinza multiuso**

■ 25578/130*				26290.4	
■ 160*	12	1,25	0,007	26291.1	▲
■ 170*				26292.8	



**Whisk / Batidor**

■ 25579/130				26293.5	
■ 160	12	1,21	0,011	26294.2	▲
■ 170				26295.9	



**Grater / Rallador**

■ 25580/130				26296.6	
■ 160	12	1,25	0,009	26297.3	▲
■ 170				26298.0	



NEW | NUEVO



**Presser / Squeezer / Pisador/ exprimidor**

25581/130*	12	6,02	0,036	26299.7	▲
------------	----	------	-------	---------	---



**Ice cream scoop / Cuchara helados**



Ref.	un.	Kg	m <sup>3</sup>	789.1112.	packaging empaque
■ 25582/130				26302.4	
■ 160	12	0,95	0,008	26303.1	▲
■ 170				26304.8	



**Opener / Destapador**



■ 25583/130				26305.5	
■ 160	12	1,12	0,005	26306.2	▲
■ 170				26307.9	



**Pizza cutter / Cortador de pizza**



■ 25584/130				26308.6	
■ 160	12	1,59	0,008	26309.3	▲
■ 170				26310.9	



**Peeler / Pelador**



Protective case  
Capa protectora

■ 25585/130				26311.6	
■ 160	12	1,01	0,005	26312.3	▲
■ 170				26313.0	



**Peeler / Pelador**



Protective case  
Capa protectora

■ 25586/130				26314.7	
■ 160	12	1,01	0,005	26315.4	▲
■ 170				26316.1	

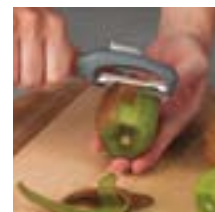



Protective case  
Capa protectora

**Peeler / Pelador**

Ref.	un.	Kg	m <sup>3</sup>	789.111.2.	packaging empaque
■ 25587/130				26317.8	
■ 160	12	1,01	0,005	26318.5	▲
■ 170				26319.2	



**Strainer / Colador (1= ø 13 cm, 2= ø 17 cm)**

■ 25588/131				26337.6	
■ 161	12	1,58	0,015	26338.3	▲
■ 171				26339.0	
■ 132				26340.6	
■ 162	12	2,58	0,026	26341.3	
■ 172				26342.0	



**6 pcs. Utensils set / Juego de utensilios 6 pzas.**

■ 25599/370				26513.4	■
■ 670	04	4,91	0,032	26508.0	
■ 770				26509.7	

**CONTENTS / CONTENIDO**

- 1 - 25570/070 - Spatula / Espátula
- 1 - 25571/070 - Serving spoon / Cuchara para servir
- 1 - 25572/070 - Ladle / Cucharón
- 1 - 25573/070 - Skimmer / Espumadera
- 1 - 25574/070 - Spaghetti server / Servidor de pasta
- 1 - 29900/506 - Holder / Soporte





# UTEN SILS

---

# UTEN SILIOS

## Fluence

- stainless steel blades | láminas de acero inoxidable
- polypropylene handles | mangos de polipropileno
- dishwasher safe | resistente a lavavajillas

### Colors | Colores

---



black | negro



mint green |  
verde menta  
4186c



red | rojo  
187c



check out the product  
in augmented reality /  
vea el producto en  
realidad aumentada



NEW | NUEVO

#### Carving fork / Tenedor trinchante

Ref.	un.	Kg	m <sup>3</sup>	789.1112.	packaging empaquetado
■ 25260/100				31300.2	
■ 120	12	1,05	0,006	31301.9	▲
■ 170				31302.6	



check out the product  
in augmented reality /  
vea el producto en  
realidad aumentada



NEW | NUEVO

#### Spatula / Espatula

■ 25261/100				31309.5	
■ 120	12	1,45	0,006	31310.1	▲
■ 170				31311.8	



check out the product  
in augmented reality /  
vea el producto en  
realidad aumentada



NEW | NUEVO

#### Skimmer / Espumadera

■ 25262/100				31312.5	
■ 120	12	1,42	0,006	31313.2	▲
■ 170				31314.9	





check out the product in augmented reality /  
vea el producto en realidad aumentada



**Ladle / Cucharón**

Ref.	un.	Kg	m <sup>3</sup>	789.1112.	packaging empaque
■ 25263/100				31318.7	
■ 120	12	1,42	0,006	31319.4	▲
■ 170				31320.0	



check out the product in augmented reality /  
vea el producto en realidad aumentada



**Serving Spoon / Cuchara para servir**

■ 25264/100				31324.8	
■ 120	12	1,42	0,006	31325.5	▲
■ 170				31326.2	







# UTEN SILS UTEN SILIOS

## Utilità

- utensils made of stainless steel and chrome-plated zamak, abs, nylon or silicone | utensilios de acero inoxidable, zamak cromado, abs, nylon o silicone
- polypropylene handles or abs | mango de polipropileno y abs
- dishwasher safe | resistente a lavavajillas

### Colors | Colores



black | negro



red | rojo  
193c



white | blanco



#### Garlic press / Triturador de ajo - Zamak

Ref.	un.	Kg	m <sup>3</sup>	789.1112.	packaging empaque
■ 25601/100				10598.0	
■ 170	12	2,53	0,004	17155.8	▲
□ 180				05941.2	



#### Ice cream scoop / Cuchara para helados

■ 25607/100				28444.9	
■ 170	12	1,11	0,005	28446.3	▲
□ 180				28447.0	



#### Ice cream scoop / Cuchara para helados

■ 25603/100				10604.8	
■ 170	12	1,55	0,007	17158.9	▲
□ 180				05961.0	



#### Can Opener / Abrelatas

■ 25605/100				11280.3	
■ 170	12	2,93	0,010	17162.6	▲
□ 180				05981.8	



#### Pastry wheel / Cortador pasta - Zamak

■ 25610/100				10608.6	
■ 170	12	1,25	0,005	17164.0	▲
□ 180				06001.2	



**Pastry wheel / Cortador pasta - Zamak**

Ref.	un.	Kg	m <sup>3</sup>	789.1112.	packaging empaque
■ 25611/100				10612.3	
■ 170	12	1,07	0,005	17166.4	▲
□ 180				06011.1	



**Fruit pulp extractor / Extractor de pulpa**

■ 25621/100				10616.1	
■ 170	12	0,75	0,005	17168.8	▲
□ 180				06079.1	



**Lemon scraper / Raspador para limón**

■ 25623/100				10620.8	
■ 170	12	0,64	0,004	17184.8	▲
□ 180				06089.0	



**Whisk / Batidor**

■ 25624/100				10658.1	
■ 170	12	1,24	0,009	17187.9	▲
□ 180				06099.9	



**Pizza cutter / Cortador de pizza**

■ 25625/100				08659.3	
■ 170	12	1,08	0,005	17189.3	▲
□ 180				06109.5	



**Mellon baller / Sacabocados  
(2 = ø 2,4 cm, 3 = ø 2,9 cm)**

■ 25626/102				10626.0	
■ 172	12	0,65	0,004	17191.6	▲
□ 182				06128.6	
■ 103				10630.7	
■ 173	12	0,76	0,005	17194.7	▲
□ 183				06129.3	



**Potato peeler / Pela papas**

■ 25627/100				10634.5	
■ 170	12	0,78	0,005	17196.1	▲
□ 180				06139.2	



**Cheese cutter / Cortador de queso**

■ 25631/100				08661.6	
■ 170	12	1,18	0,005	17198.5	▲
□ 180				06149.1	

**Pizza spatula / Espátula pizza**



Ref.	un.	Kg	m <sup>3</sup>	789.1112.	packaging empaques
■ 25632/100				08662.3	
■ 170	12	1,31	0,007	17200.5	▲
□ 180				06163.7	

**Cake server / Espátula para tartas**



■ 25633/100				10642.0	
■ 170	12	1,30	0,007	17201.2	▲
□ 180				06173.6	

**Sauce ladle / Cucharón salsa**



■ 25638/100				10692.5	
■ 170	12	0,92	0,007	17209.8	▲
□ 180				06213.9	

**Mini-grater / Mini-rallador**



■ 25640/100				10580.5	
■ 170	12	1,08	0,005	17211.1	▲
□ 180				06223.8	

**Mini-grater / Mini-rallador**



■ 25641/100				10584.3	
■ 170	12	1,00	0,005	17213.5	▲
□ 180				06233.7	

**Grater / Rallador**



■ 25685/100				16902.9	
■ 170	12	1,24	0,006	16904.3	▲
□ 180				16905.0	

**Carving fork / Tenedor trinchante**



■ 25650/100				08664.7	
■ 170	12	1,05	0,006	17215.9	▲
□ 180				06243.6	

**Spatula / Espátula**



■ 25651/100				08666.1	
■ 170	12	1,45	0,006	17217.3	▲
□ 180				06253.5	



**Skimmer / Espumadera**

Ref.	un.	Kg	m <sup>3</sup>	789.1112.	packaging empaque
■ 25652/100					08668.5
■ 170	12	1,42	0,006		17218.0 ▲
□ 180					06263.4



**Ladle / Cucharón**

■ 25653/100					08670.8
■ 170	12	1,72	0,009		17219.7 ▲
□ 180					06273.3



**Serving spoon / Cuchara para servir**

■ 25654/100					08672.2
■ 170	12	1,42	0,006		17220.3 ▲
□ 180					06283.2



**Potato masher / Puretera**

■ 25655/100					10654.3
■ 170	12	1,75	0,011		17221.0 ▲
□ 180					06293.1



**Whisk / Batidor manual - nylon**

■ 25674/100					09774.2
■ 170	12	0,89	0,008		17223.4 ▲



**Spatula / Espátula - nylon**

■ 25690/100					17096.4
■ 170	12	1,32	0,006		17098.8 ▲



**Skimmer / Espumadera - nylon**

■ 25691/100					17104.6
■ 170	12	1,30	0,006		17106.0 ▲



**Ladle / Cucharón - nylon**

■ 25692/100					17112.1
■ 170	12	1,59	0,011		17114.5 ▲



**Serving spoon / Cuchara para servir - nylon**

■ 25693/100					17120.6
■ 170	12	1,35	0,007		17122.0 ▲



### Spaguetti server / Servidor de pasta - nylon

Ref.	un.	Kg	m <sup>3</sup>	789.1112.	packaging empaque
■ 25694/100	12	1,24	0,007	17128.2	▲
■ 170				17130.5	



### Multiuse tong / Pinza multiuso (24 cm)

■ 25056/160	12	1,78	0,010	21166.7	▲
■ 170				23079.8	



### Multiuse tong / Pinza multiuso (30 cm)

■ 25057/160	12	2,14	0,013	21167.4	▲
■ 170				23072.9	



### Grater / Rallador

■ 25106/400				12399.1	
■ 470	12	1,46	0,006	21268.8	●
□ 480				12400.4	



### Grater/ Rallador

■ 25695/100				17136.7	
■ 170	12	1,59	0,007	17138.1	▲
□ 180				17139.8	



### Egg slicer / Cortador de huevos

□ 25029/180*	12	1,10	0,008	02675.9	▲
--------------	----	------	-------	---------	---



### 4 Sided grater / Rallador 4 lados

□ 25110/180*	12	2,86	0,023	02700.8	▲
--------------	----	------	-------	---------	---

Rim: Stainless Steel  
Mesh: Stainless Steel  
Aro: Acero inoxidable  
Malla: Acero inoxidable



Rim: Stainless Steel  
Mesh: Stainless Steel  
Aro: Acero inoxidable  
Malla: Acero inoxidable



### Strainer / Colador

(1 = ø9cm, 2 = ø13cm, 3 = ø17cm)

■ 25680/101		1,24	0,009	10702.1	
■ 102	12	1,83	0,012	10706.9	▲
■ 103		2,24	0,012	10710.6	



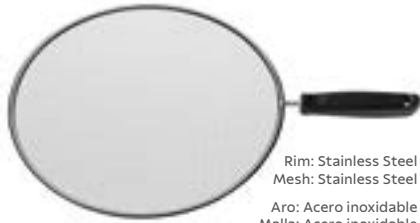

Rim: Stainless Steel  
Mesh: Stainless Steel  
Aro: Acero inoxidable  
Malla: Acero inoxidable

**Splatter screen / Malla para fritura (ø30cm)**

Ref.	un.	Kg	m³	789.1112.	packaging empaque
■ 25681/100	12	2,39	0,016	10714.4	▲



**Silicone pastry brush / Pincel de silicone**

25682/100*	12	1,37	0,004	13712.7	▲
------------	----	------	-------	---------	---



**Digital Thermometer / Termometro digital**

25683/100*	12	1,00	0,007	13706.6	◐
------------	----	------	-------	---------	---



**Oyster knife / Cuchillo para ostra**

25684/100*	12	0,99	0,009	13708.0	▲
------------	----	------	-------	---------	---



**Pastry bag and tips for decorating / Manga y baquillas de repostería**

29899/060*	12	2,85	0,013	23006.4	▲
------------	----	------	-------	---------	---



**5 pcs. Measuring spoons / Cucharas medidoras 5 pzas.**

29899/061*	12	0,88	0,006	23007.1	▲
------------	----	------	-------	---------	---



**4 pcs. Measuring cups / Tazas medidoras 4 pzas.**

29899/062*	12	2,14	0,026	23008.8	▲
------------	----	------	-------	---------	---



# UTEN SILS

# UTEN SILIOS

## Ability

- nylon utensils | utensilios de nylon
- heat resistant up to 180° C (356°F) | resistente hasta 180°C
- dishwasher safe | resistente a lavavajillas

### Colors | Colores



black | negro



graphite | grafito  
cool gray 10c



marsala | marsala  
188c



#### Spatula / Espátula

Ref.	un.	Kg	m <sup>3</sup>	789.1112.	packaging empaque
■ 25155/100				28473.9	
■ 160	12	0,78	0,007	20795.0	▲
■ 170				20796.7	



#### Serving spoon / Cuchara para servir

■ 25156/100				28474.6	
■ 160	12	0,82	0,007	20797.4	▲
■ 170				20798.1	



#### Ladle / Cucharón

■ 25157/100				28475.3	
■ 160	12	0,96	0,007	20799.8	▲
■ 170				20800.1	



#### Skimmer / Espumadera

■ 25158/100				28476.0	
■ 160	12	0,94	0,010	20801.8	▲
■ 170				20802.5	



#### Pancake / sauce ladle / Cuchara para panqueca / salsa

■ 25159/100				28477.7	
■ 160	12	0,65	0,005	20803.2	▲
■ 170				20804.9	



**Spatula / Espátula**

Ref.	un.	Kg	m <sup>3</sup>	789.1112.	packaging empaque
■ 25160/100				28478.4	
■ 160	12	0,78	0,007	20805.6	▲
■ 170				20806.3	



**Serving spoon / Cuchara para servir**

■ 25161/100				28479.1	
■ 160	12	0,78	0,006	20807.0	▲
■ 170				20808.7	



**Spaguetti server / Servidor de pasta**

■ 25162/100				28480.7	
■ 160	12	0,82	0,009	20809.4	▲
■ 170				20810.0	



**Multiuse tong / Pinza multiuso**

■ 25163/100				28481.4	
■ 160	12	1,33	0,012	20811.7	▲
■ 170				20812.4	



**Cake server / Espátula para torta**

■ 25164/100				28482.1	
■ 160	12	0,78	0,007	20813.1	▲
■ 170				20814.8	



**Knife for pies, cakes, salads / Cuchillo para tortas y ensaladas**

■ 25165/100				28483.8	
■ 160	12	0,89	0,009	20815.5	▲
■ 170				20816.2	



**Egg spatula / Espátula para huevo**

■ 25166/100				28485.2	
■ 160	12	0,55	0,005	22092.8	▲
■ 170				22093.5	

NEW | NUEVO



3 pcs. Utensils set / Juego de utensilios 3 pzas.

Ref.	un.	Kg	m <sup>3</sup>	789.1112.	packaging empaque
■ 25199/011				31201.2	
■ 611	10	1,81	0,016	31202.9	▲
■ 711				31203.6	

CONTENTS / CONTENIDO

- 1 - 25155/000 - Spatula / Espatula
- 1 - 25156/000 - Serving spoon / Cuchara para servir
- 1 - 25157/000 - Ladle / Cucharón

NEW | NUEVO



5 pcs. Utensils set / Juego de utensilios 5 pzas.

■ 25199/007				29094.5	
■ 607	10	2,89	0,026	31199.2	▲
■ 707				31200.5	

CONTENTS / CONTENIDO

- 1 - 25155/000 - Spatula / Espatula
- 1 - 25156/000 - Serving spoon / Cuchara para servir
- 1 - 25157/000 - Ladle / Cucharón
- 1 - 25158/000 - Skimmer / Espumadera
- 1 - 25159/000 - Pancake/sauce ladle / Cuchara para panqueca/salsa





# UTEN SILS

---

# UTEN SILIOS

**Movin**

- nylon utensils | utensílios de nylon
- stainless steel handles | mangos de acero inoxidable
- heat resistant up to 180° C (356°F) | resistente hasta 180°C
- dishwasher safe | resistente a lavavajillas



watch the video



vea el vídeo

## Colors | Colores



blue | azul  
211c



grey | gris  
432c



lilac | lila  
242c



### Spatula / Espátula

Ref.	un.	Kg	m <sup>3</sup>	789.1112.	packaging empaque
■ 25751/110				26466.3	
■ 160	12	1,27	0,006	26467.0	▲
■ 190				26468.7	



### Skimmer / Espumadera

■ 25752/110				26469.4	
■ 160	12	1,32	0,006	26470.0	▲
■ 190				26471.7	



### Ladle / Cucharón

■ 25753/110				26472.4	
■ 160	12	1,57	0,010	26473.1	▲
■ 190				26474.8	







**Serving spoon / Cuchara para servir**

Ref.	un.	Kg	m <sup>3</sup>	789.1112.	packaging empaque
■ 25754/110				26475.5	
■ 160	12	1,26	0,006	26476.2	▲
■ 190				26477.9	



**Spaghetti Server / Servidor de pasta**

■ 25755/110				26478.6	
■ 160	12	1,19	0,006	26479.3	▲
■ 190				26480.9	



**Spatula / Espátula**

■ 25756/110				26481.6	
■ 160	12	1,35	0,007	26482.3	▲
■ 190				26483.0	



**5 pcs. Utensils set / Juego utensilios 5 pzas.**

■ 25799/150				26510.3	
■ 650	04	3,87	0,065	26511.0	■
■ 950				26512.7	

**CONTENTS / CONTENIDO**

- 1 - 25751/010 - Spatula / Espátula
- 1 - 25752/010 - Skimmer / Espumadera
- 1 - 25753/010 - Ladle / Cucharón
- 1 - 25754/010 - Serving spoon / Cuchara para servir
- 1 - 25755/010 - Spaghetti Server / Servidor de pasta



# UTEN SILS

---

# UTEN SILIOS

## Apreciatta

- silicone utensils | utensilios de silicone
- stainless steel handles | mangos de acero inoxidable
- heat resistant up to 210 °C (410°F) | resistente hasta 210°C
- dishwasher safe | resistente a lavavajillas



### Silicone glove / Guante de silicone

Ref.	un.	Kg	m <sup>3</sup>	789.1112.	packaging empaques
25785/100*	12	2,97	0,021	09049.1	▲



### Spatula / Espátula

25800/100*	12	1,50	0,007	13516.1	▲
------------	----	------	-------	---------	---



### Serving spoon / Cuchara para servir

25801/100*	12	1,49	0,007	13518.5	▲
------------	----	------	-------	---------	---



### Skimmer / Espumadera

25802/100*	12	1,64	0,010	13520.8	▲
------------	----	------	-------	---------	---



### Ladle / Cucharón

25803/100*	12	1,79	0,010	13522.2	▲
------------	----	------	-------	---------	---



### Spaghetti server / Servidor de pasta

25804/100*	12	1,35	0,007	13524.6	▲
------------	----	------	-------	---------	---



### Spatula / Espátula

25807/100*	12	1,20	0,004	16053.8	▲
------------	----	------	-------	---------	---



### Whisk / Batidor manual

25808/100*	12	0,82	0,010	16055.2	▲
------------	----	------	-------	---------	---



# UTEN SILS

---

# UTEN SILIOS

## Lyon

- silicone utensils with reinforced interior | utensilios de silicone con refuerzo interno
- heat resistant up to 180 °C (356°F) | resistente hasta 180°C
- dishwasher safe | resistente a lavavajillas



### Spatula / Espátula

Ref.	un.	Kg	m <sup>3</sup>	789.1112.	packaging empaque
25830/100*	06	1,18	0,007	16274.7	▲



### Serving spoon / Cuchara para servir

25831/100*	06	0,95	0,006	16276.1	▲
------------	----	------	-------	---------	---



### Ladle / Cucharón

25832/100*	06	1,35	0,009	16278.5	▲
------------	----	------	-------	---------	---



### Spatula / Espátula

25833/100*	06	0,83	0,004	16280.8	▲
------------	----	------	-------	---------	---



### Serving spoon / Cuchara para servir

25835/100*	06	0,27	0,001	16282.2	▲
------------	----	------	-------	---------	---



### Spatula / Espátula

25836/100*	06	0,26	0,001	16284.6	▲
------------	----	------	-------	---------	---



### Silicone pastry brush / Pincel de silicone

25837/100*	06	0,30	0,001	16286.0	▲
------------	----	------	-------	---------	---



### Utensils rest / Apoyo para utensilios

25840/100*	06	0,45	0,001	16288.4	▲
------------	----	------	-------	---------	---



### Triset / Apoyo para ollas

25841/100*	06	1,63	0,005	16290.7	▲
------------	----	------	-------	---------	---

# HAR MO NIZA

**IT GOES WITH EVERYTHING,  
INCLUDING YOU. | COMBINA CON TODO,  
INCLUSO CON USTED.**

During the week, wake up, have breakfast, work, return home and relax with the Harmoniza Tramontina line. On weekends, you are the one who decides when to open and enjoy a good wine. There is no rule, no day, no right time to enjoy life and combine your favorite grape with a good cheese. As sharing makes each moment more special, do not forget to also harmonize these moments with those you love the most.

Durante la semana, levántese, tome café, trabaje, vuelva a casa y relájese con la línea Harmoniza Tramontina. Los fines de semana es usted quien decide cuándo abrir y disfrutar un buen vino. No existe regla, ni día, ni hora adecuada para aprovechar la vida y combinar su uva preferida con un buen queso. Como compartir hace cada momento más especial, recuerde armonizar estos momentos también con quienes más aprecia.

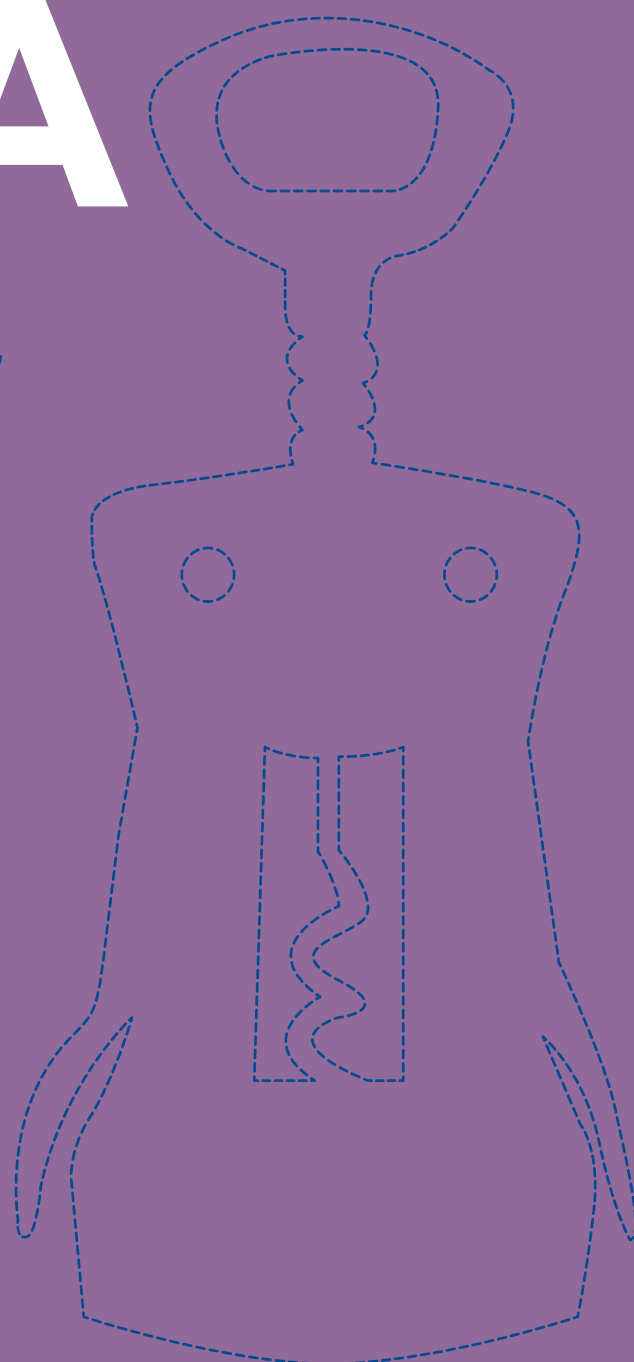





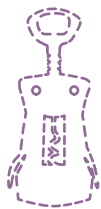

**HAR  
MO  
NIZA**



watch the video



vea el vídeo

## Colors | Colores



black | negro



red | rojo  
193c



### Winged corkscrew / Abridor / sacacorchos

Ref.	un.	Kg	m <sup>3</sup>	789.1112.	packaging empaque
■ 25550/100	06	1,52	0,010	26576.9	
■ 170				26577.6	



### Corkscrew with built-in foil cutter / Sacacorchos con cortalacre

■ 25551/100	06	1,37	0,010	26582.0	
■ 170				26583.7	



### Opener / corkscrew / pocket knife / Abridor / sacacorchos / navaja

■ 26330/100	12	1,29	0,003	10788.5	
■ 170				17711.6	



### 2 - Stage waiter's corkscrew / Abridor / sacacorchos sommelier - 2 etapas

■ 25552/100	12	1,44	0,009	26579.0	
■ 170				26580.6	



### Corkscrew / Sacacorchos

Ref.	un.	Kg	m³	789.1112.	packaging empaques
26337/100*	12	1,22	0,005	11672.6	



### Foil cutter / Cortalacre

25553/100*	12	0,65	0,004	26451.9	
------------	----	------	-------	---------	--



### Drip-free wine pourer / Cortagotas

25554/100*	12	0,71	0,005	26453.3	
------------	----	------	-------	---------	--



### Wine drip collar / Aro salvagotas

25555/100*	12	0,58	0,005	26455.7	
------------	----	------	-------	---------	--



### Wine bottle stopper / Tapa para botella de vino

25556/100*	12	1,02	0,005	26457.1	
------------	----	------	-------	---------	--



### 3 pcs. Wine set / Juego para vino 3 pzas.

25599/010	04	1,07	0,005	26458.8	
-----------	----	------	-------	---------	--

#### CONTENTS / CONTENIDO

1 - 25552/000 - 2 Stage waiter's corkscrew / Abridor / sacacorchos sommelier - 2 etapas

1 - 25554/100 - Wine drip collar / Aro salvagotas

1 - 25556/100 - Wine bottle stopper / Tapa para botella de vino



### 5 pcs. Wine set / Juego para vino 5 pzas.

25599/011	04	1,90	0,011	26459.5	
-----------	----	------	-------	---------	--

#### CONTENTS / CONTENIDO

1 - 25550/000 - Winged corkscrew / Abridor / sacacorchos

1 - 25553/100 - Foil cutter / Cortalacre

1 - 25554/100 - Drip-free wine pourer / Cortagotas

1 - 25555/100 - Wine drip collar / Aro salvagotas

1 - 25556/100 - Wine bottle stopper / Tapa para botella de vino



**Wine saver and stoppers / Bomba de vacío y tapas**

Ref.	un.	Kg	m³	789.1112.	packaging empaque
25599/012*	04	0,95	0,007	26462.5	

**CONTENTS / CONTENIDO**

- 1 - Vacuum pump / Bomba de vacío
- 2 - Stoppers / Tapas



**2 pcs. Wine set saver stoppers /  
Tapas para bomba de vacío 2 pzas.**

25599/013*	12	1,11	0,014	26463.2	
------------	----	------	-------	---------	--

**CONTENTS / CONTENIDO**

- 2 - Wine saver stoppers / Tapas para bomba de vacío



**(6") Cheese knife / Cuchillo para queso**

21177/176	12	1,07	0,004	26183.9	
196				26184.6	





### 5 pcs. Cheese serving set / Juego para queso 5 pzas.

Ref.	un.	Kg	m³	789.1112.	packaging empaque
■ 21399/755	05	1,60	0,008	22792.7	
■ 955				22793.4	

#### CONTENTS / CONTENIDO

- 1 - 21370/090 - Cheese knife for hard cheeses / Cuchillo para quesos duros
- 1 - 21371/090 - Cheese knife for semi-hard and soft cheeses / Cuchillo para quesos semiduros y blandos
- 1 - 21372/090 - Cheese fork / Tenedor para queso
- 1 - 21373/090 - Cheese knife for semi-hard and soft cheeses / Cuchillo para quesos semiduros y blandos
- 1 - 21374/090 - Cheese knife for semi-hard and hard cheeses / Cuchillo para queso semiduros y duros



### 3 pcs. Cheese serving set / Juego para queso 3 pzas.

■ 23498/018	05	1,02	0,005	22906.8	
■ 718				26533.2	

#### CONTENTS / CONTENIDO

- 1 - 23435/000 - Cheese knife for hard cheeses / Cuchillo para quesos duros
- 1 - 23437/000 - Cheese fork / Tenedor para queso
- 1 - 23438/000 - Cheese knife for semi-hard and soft cheeses / Cuchillo para quesos semiduros y blandos



### 5 pcs. Cheese serving set / Juego para queso 5 pzas.

■ 23498/019	05	1,44	0,008	22909.9	
■ 719				26535.6	

#### CONTENTS / CONTENIDO

- 1 - 23435/000 - Cheese knife for hard cheeses / Cuchillo para quesos duros
- 1 - 23436/000 - Cheese knife for semi-hard and soft cheeses / Cuchillo para quesos semiduros y blandos
- 1 - 23437/000 - Cheese fork / Tenedor para queso
- 1 - 23438/000 - Cheese knife for semi-hard and soft cheeses / Cuchillo para quesos semiduros y blandos
- 1 - 23439/000 - Cheese knife for semi-hard and hard cheeses / Cuchillo para quesos semiduros y duros

## types of CHEESE

## tipos de QUESO



Cheese knife for hard cheese

Cuchillo para quesos duros



Cheese knife for semi-hard and soft cheeses

Cuchillo para quesos semiduros y blandos



Cheese knife for semi-hard and hard cheeses

Cuchillo para quesos semiduros y duros



Fork for all types of cheeses

Tenedor para todos tipos de queso

# SCISSORS

# TIJERAS

**THERE ARE THINGS THAT DO NOT CHANGE WITH TIME. LIKE THE COMFORT WHEN USING TRAMONTINA SCISSORS, FOR EXAMPLE. | HAY COSAS QUE NO CAMBIAN CON EL TIEMPO. EL CONFORT AL UTILIZAR UNA TIJERA TRAMONTINA, POR EJEMPLO.**

**176. Monstercort**

**178. Professional | Profesionales**

**179. Supercort**

**181. Professional | Profesionales**

From the first cutouts and collages in the classroom to the intense manual work required by the industry, Tramontina has scissors to meet different uses and needs. With comfortable handles, ergonomic design and precise blades, accurate cutting and contouring is much more practical in all activities.

Desde los primeros recortes y collages en los salones de clase hasta los trabajos manuales e intensos que la industria exige, Tramontina posee tijeras para satisfacer diversos usos y necesidades. Con mangos cómodos de manejar, diseño ergonómico y láminas precisas, cortar con exactitud y hacer contornos es mucho más práctico en todas las actividades.

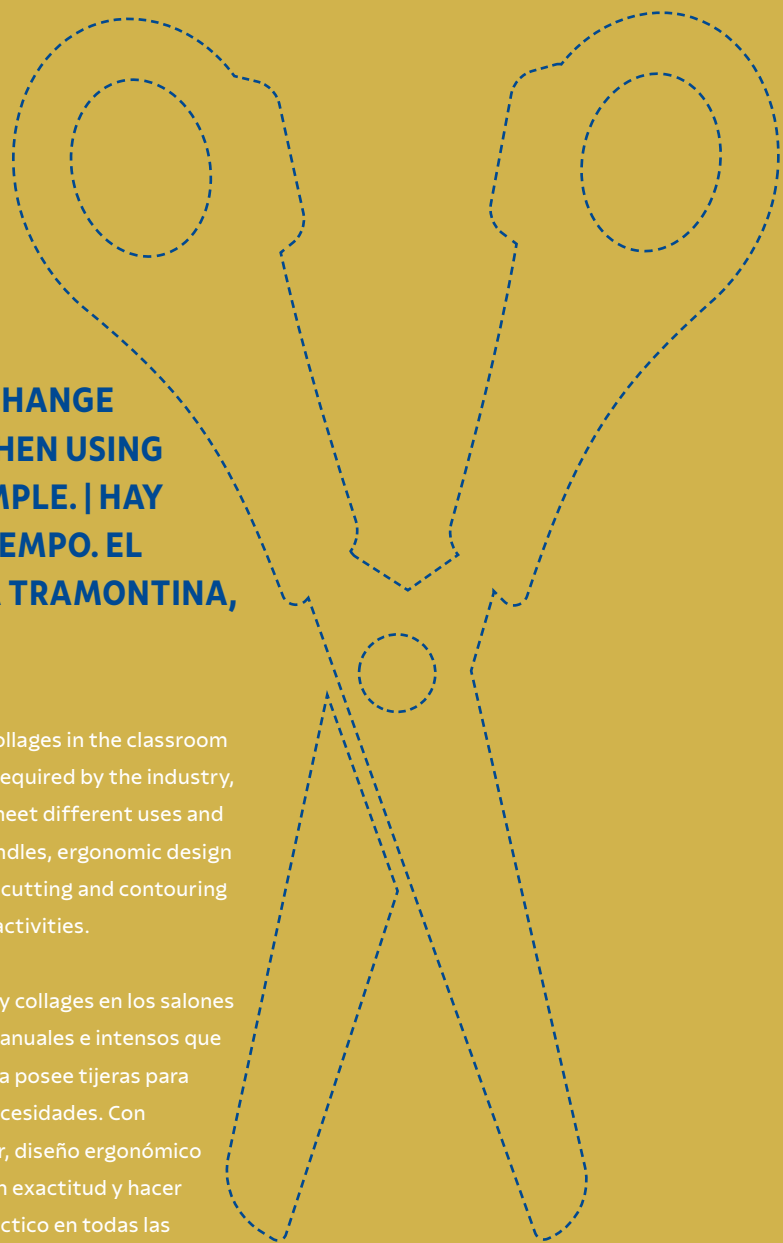









SCIS  
SORS

TIJE  
RAS

## Monstercort

- stainless steel blades with rounded tips | láminas de acero inoxidable con puntas redondeadas
- ergonomic handles made of polypropylene | mangos anatómicos de polipropileno
- various colors | diversos colores
- rivet-secured blades | láminas fijadas con remaches



**(4") School scissors - Assorted colours (12 pcs.)**  
**Tijera escolar - Colores surtidos adentro (12 pzas.)**

Ref.	un.	Kg	m³	789.1112.	packaging empaques
25900/144	60	1,30	0,009	01963.8	1

CONTENTS / CONTENIDO

- 6 - 25900/004
- 2 - 25900/014
- 2 - 25900/044
- 2 - 25900/094



**(4") School scissors display - 72 pcs.**  
**Display tijeras - 72 pzas.**

25999/409	04	4,08	0,034	15075.1	●
-----------	----	------	-------	---------	---

CONTENTS / CONTENIDO

- 30 - 25900/004
- 14 - 25900/014
- 14 - 25900/044
- 14 - 25900/094



**(5") School scissors / Tijera escolar**

25901/105	60	2,11	0,010	00235.7	1
-----------	----	------	-------	---------	---

CONTENTS / CONTENIDO

- 60 - 25901/005



**(5") School scissors - Assorted colours inside of the carton (12 pcs.)**  
**Tijera escolar - Colores surtidos adentro de la caja interna (12 pzas.)**

25901/145	60	2,11	0,010	15073.7	1
-----------	----	------	-------	---------	---

CONTENTS / CONTENIDO

- 6 - 25901/005
- 2 - 25901/015
- 2 - 25901/075
- 2 - 25901/095



**30 pcs. Scissors display / Display tijeras 30 pzas.**

Ref.	un.	Kg	m <sup>3</sup>	789.1112.	packaging empaque
25999/010	04	3,59	0,032	15074.4	●

CONTENTS / CONTENIDO  
30 - 25901/005



**30 pcs. Scissors display / Display tijeras 30 pzas.**

25999/410	04	3,50	0,034	15076.8	●
-----------	----	------	-------	---------	---

CONTENTS / CONTENIDO  
 ■ 9 - 25901/005  
 ■ 7 - 25901/015  
 ■ 7 - 25901/075  
 ■ 7 - 25901/095



**(5") School scissors - Assorted colours (15 pcs.)  
Tijera escolar - Colores surtidos (15 pzas.)**

25930/995	60	2,12	0,011	26595.0	1
-----------	----	------	-------	---------	---

CONTENTS / CONTENIDO  
 ■ 3 - 25930/015  
 ■ 3 - 25930/035  
 ■ 3 - 25930/045  
 ■ 3 - 25930/055  
 ■ 3 - 25930/065



**(5") School scissors display - 20 pcs.  
Display tijeras - 20 pzas.**

25999/913	04	2,77	0,33	26596.7	●
-----------	----	------	------	---------	---

CONTENTS / CONTENIDO  
 ■ 4 - 25930/015  
 ■ 4 - 25930/035  
 ■ 4 - 25930/045  
 ■ 4 - 25930/055  
 ■ 4 - 25930/065

**For left-handed kids  
Para zurdos**



**(5") School scissors - Assorted colours (15 pcs.)  
Tijera escolar - Colores surtidos adentro (15 pzas.)**

25929/995	60	2,12	0,011	26594.3	1
-----------	----	------	-------	---------	---

CONTENTS / CONTENIDO  
 ■ 3 - 25929/015  
 ■ 3 - 25929/035  
 ■ 3 - 25929/045  
 ■ 3 - 25929/055  
 ■ 3 - 25929/065



# SCISSORS TIJERAS

## Professional | Profesionales

- stainless steel blades | láminas de acero inoxidable
- ergonomic polypropylene handles | mangos anatómicos de polipropileno
- blades secured with screws | fijación con tornillos



### (7",8",10") Sewing scissors - Razor edge (plain) Tijera para costura - Filo navaja (liso)

Ref.	un.	Kg	m <sup>3</sup>	789.1112.	packaging empaque
25925/167		1,04	0,004	28098.4	
168	12	1,30	0,004	28099.1	▲
160		1,93	0,007	28100.4	



### (8", 10") Sewing scissors - Laser-cut edge (serrated) Tijera para costura - Filo láser (microdentado)

Ref.	un.	Kg	m <sup>3</sup>	789.1112.	packaging empaque
25926/168		1,13	0,004	28101.1	
160	12	1,93	0,007	28102.8	▲





# SCISSORS TIJERAS

## Supercort

- stainless steel blades | láminas de acero inoxidable
- ergonomic polypropylene handles | mangos anatómicos de polipropileno
- blades secured with screws or rivets | fijación con tornillos o remaches



watch the video



vea el vídeo

### Colors | Colores



carmim  
7425c



off-white  
cool gray 1c



turquesa  
7466c



ônix  
432c



pink / rosa  
2040c



#### (8") Kitchen / carving scissors / Tijera de cocina / trinchante

Ref.	un.	Kg	m <sup>3</sup>	789.1112.	packaging empaque
25919/168	12	2,25	0,007	28097.7	▲



#### (9") Kitchen / carving scissors / Tijera de cocina / trinchante

25920/169	12	1,46	0,004	28094.6	▲
-----------	----	------	-------	---------	---



#### (7", 8") Sewing scissors / Tijera para coser Assorted colours / Colores surtidos

25950/147	48	4,23	0,028	02701.5	1
148		4,57	0,028	02702.2	

#### CONTENTS / CONTENIDO

- 6 - 25950/007
- 2 - 25950/717
- 2 - 25950/787
- 2 - 25950/797







**(6") Barber scissors - Razor edge (smooth)**  
**Tijera para cabello - Filo navaja (liso)**

Ref.	un.	Kg	m <sup>3</sup>	789.1112.	packaging empaque
25905/166	12	0,55	0,003	28096.0	1



**(6") Barber scissors with finger rest - Thinning edge**  
**Tijera para cabello con descanso - Filo desbaste**

■ 25911/146	12	0,49	0,002	28092.2	▲
■ 166				28093.9	



**(6") Barber scissors with finger rest - Laser-cut edge (serrated)**  
**Tijera para cabello con descanso - Filo láser (microdentado)**

■ 25910/146	12	0,47	0,002	28090.8	▲
■ 166				28091.5	



**(5") Barber scissors with finger rest - Razor edge (smooth)**  
**Tijera para cabello con descanso - Filo navaja (liso)**

■ 25910/145	12	0,38	0,002	28088.5	▲
■ 165				28089.2	





# SCISSORS TIJERAS

## Professional | Profesionales

- 100% stainless steel | 100% acero inoxidable
- removable silicone rings | juntas de silicone removibles
- silicone shock absorber | amortiguador de silicone para impactos
- finger support | apoyo para dedo
- pressure adjusting screw | tornillo para ajuste de presión
- designed for professionals who want precise cuts | desarrollada para los profesionales que desean cortes precisos



**(6") Hair shears - Thinning edge**  
**Tijera para cabello - Filo desbaste**

Ref.	un.	Kg	m <sup>3</sup>	789.1112.	packaging empaque
25987/006*	06	0,83	0,004	24552.5	



watch the video



vea el vídeo



**(6") Hair shears - Laser-cut edge (serrated)**  
**Tijera para cabello - Filo láser (microdentado)**

25986/006*	06	0,83	0,004	24551.8	
------------	----	------	-------	---------	--



**(5,5") Hair shears - Razor edge (smooth)**  
**Tijera para cabello - Filo navaja (liso)**

25985/005*	06	0,83	0,005	24550.1	
------------	----	------	-------	---------	--



**(5,5") Hair shears - Thinning edge**  
**Tijera para cabello - Filo desbaste**

25982/005*	06	0,75	0,003	24549.5	
------------	----	------	-------	---------	--



watch the video



vea el vídeo



**(6") Hair shears - Laser-cut edge (serrated)**  
**Tijera para cabello - Filo láser (microdentado)**

25981/006*	06	0,71	0,003	24548.8	
------------	----	------	-------	---------	--



**(5") Hair shears - Razor edge (smooth)**  
**Tijera para cabello - Filo navaja (liso)**

25980/005*	06	0,68	0,003	24547.1	
------------	----	------	-------	---------	--

# CHILDREN



# INFANTIL

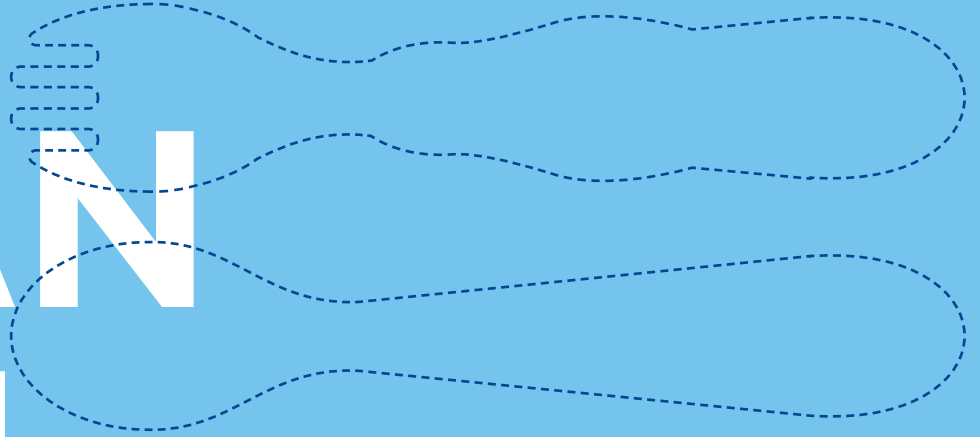

**THE MORE COLOR ON THE PLATE, THE BETTER. AND IN THE FLATWARE, TOO. |  
CUANTO MÁS COLOR EN EL PLATO, MEJOR. Y EN LOS CUBIERTOS TAMBIÉN.**

**184. *Le Petit***

**185. *Baby Friends***

**187. *Lirous***

When you are a child, the rule is clear: there is no rule to have fun and learn by playing.

A plate can turn into a drum, or it can be a fun and very healthy dish. A spoon can turn into a drumstick, or it can be a spoon to eat all the food on the plate. And so with so many other products, which are colorful, arouse curiosity and are versatile to always stimulate the development of little ones.

Quando se es niño, la regla es clara: no hay reglas para divertirse y aprender jugando.

Un plato se puede convertir en un tambor, o puede ser un plato divertido y muy sano. Una cuchara puede convertirse en un palillo, o puede ser una cuchara para comer toda la comida en el mismo plato. Y así con tantos otros productos, que son coloridos, que despiertan la curiosidad y que son versátiles para que siempre estimulen el desarrollo de los pequeños.







# CHILDREN INFANTIL

- container, lid and flatware made of polypropylene | pote, tapa y cubiertos de polipropileno
- silicone bib | babero de silicone



## Le Petit

NEW | NUEVO

+6m



### 2 pcs. Children's flatware set / Juego de cubiertos infantil 2 pzas.

Ref.	un.	Kg	m <sup>3</sup>	789.1112.	packaging empaque
23797/402	12	0,55	0,003	29951.1	2

CONTENTS / CONTENIDO  
1 - 23774/040 - Fork / Tenedor  
1 - 23775/040 - Spoon / Cuchara

NEW | NUEVO

+6m



### 2 pcs. Children's flatware set / Juego de cubiertos infantil 2 pzas.

23797/602	12	0,55	0,003	29950.4	2
-----------	----	------	-------	---------	---

CONTENTS / CONTENIDO  
1 - 23774/060 - Fork / Tenedor  
1 - 23775/060 - Spoon / Cuchara

NEW | NUEVO

+6m



### 2 pcs. Bib + Children's spoon set / Kit babero + cuchara infantil 2 pzas.

23797/404	06	0,90	0,008	29955.9	▲
-----------	----	------	-------	---------	---

CONTENTS / CONTENIDO  
1 - 23775/040 - Spoon / Cuchara  
1 - 23778/060 - Bib / Babero

NEW | NUEVO

+6m



### 2 pcs. Bib + Children's spoon set / Kit babero + cuchara infantil 2 pzas.

23797/604	06	0,90	0,008	29954.2	▲
-----------	----	------	-------	---------	---

CONTENTS / CONTENIDO  
1 - 23775/060 - Spoon / Cuchara  
1 - 23778/060 - Bib / Babero

NEW | NUEVO

+6m



### 3 pcs. Children's set / Juego infantil 3 pzas.

23797/403	10	1,84	0,033	29953.5	3
-----------	----	------	-------	---------	---

CONTENTS / CONTENIDO  
1 - 23774/040 - Fork / Tenedor  
1 - 23775/040 - Spoon / Cuchara  
1 - 23780/040 - 300 ml Container / Pote 300 ml

NEW | NUEVO

+6m



### 3 pcs. Children's set / Juego infantil 3 pzas.

23797/603	10	1,84	0,033	29952.8	3
-----------	----	------	-------	---------	---

CONTENTS / CONTENIDO  
1 - 23774/060 - Fork / Tenedor  
1 - 23775/060 - Spoon / Cuchara  
1 - 23780/060 - 300 ml Container / Pote 300 ml





# CHILDREN

# INFANTIL

## Baby Friends

- stainless steel blades | lâminas de acero inoxidable
- polypropylene plate and handles | mangos y plato de polipropileno



NEW | NUEVO

+12m



### 2 pcs. Children's flatware set / Juego de cubiertos infantil 2 pzas.

Ref.	un.	Kg	m³	789.1112.	packaging empaque
23797/905	12	1,03	0,008	29958.0	2

CONTENTS / CONTENIDO

- 1 - 23795/030 - Fork / Tenedor
- 1 - 23796/050 - Spoon / Cuchara

NEW | NUEVO

+36m



### 3 pcs. Children's flatware set / Juego de cubiertos infantil 3 pzas.

23797/906	12	1,33	0,008	29957.3	3
-----------	----	------	-------	---------	---

CONTENTS / CONTENIDO

- 1 - 23794/023 - 3" Knife / Cuchillo 3"
- 1 - 23795/030 - Fork / Tenedor
- 1 - 23796/050 - Spoon / Cuchara

NEW | NUEVO

+12m



### Plate / Plato - ø 20 cm

23776/120	12	1,89	0,015	29935.1	1
-----------	----	------	-------	---------	---

NEW | NUEVO

+12m



### Plate / Plato - ø 20 cm

23776/130	12	1,89	0,015	29936.8	1
-----------	----	------	-------	---------	---

NEW | NUEVO

+12m



### Plate / Plato - ø 20 cm

23776/150	12	1,89	0,015	29937.5	1
-----------	----	------	-------	---------	---

NEW | NUEVO

+12m



**3 pcs. Children's set / Juego infantil 3 pzas.**

Ref.	un.	Kg	m <sup>3</sup>	789.1112.	packaging empaque
23797/907	10	2,05	0,015	29959.7	3

CONTENTS / CONTENIDO  
 1 - 23776/030 - Plate / Plato - ø 20 cm  
 1 - 23795/030 - Fork / Tenedor  
 1 - 23796/050 - Spoon / Cuchara

NEW | NUEVO

+36m



**5 pcs. Children's set/ Juego infantil 5 pzas.**

23797/908	05	2,54	0,045	29956.6	5
-----------	----	------	-------	---------	---

CONTENTS / CONTENIDO  
 1 - 23776/020 - Plate / Plato - ø 20 cm  
 1 - 23781/020 - 600 ml Container / Pote 600 ml  
 1 - 23794/023 - 3" Knife / Cuchillo 3"  
 1 - 23795/030 - Fork / Tenedor  
 1 - 23796/050 - Spoon / Cuchara





# CHILDREN INFANTIL

## Lirous

- stainless steel blades | lâminas de acero inoxidable
- polypropylene plate, cup and handles | mangos, vaso e plato de polipropileno



NEW | NUEVO

+12m



### 2 pcs. Children's flatware set / Juego de cubiertos infantil 2 pzas.

Ref.	un.	Kg	m <sup>3</sup>	789.1112.	packaging empaque
23797/909	12	1,00	0,007	30220.4	2

CONTENTS / CONTENIDO  
1 - 23789/070 - Fork / Tenedor  
1 - 23790/020 - Spoon / Cuchara

NEW | NUEVO

+36m



### 3 pcs. Children's flatware set / Juego de cubiertos infantil 3 pzas.

23797/910	12	1,46	0,008	30221.1	3
-----------	----	------	-------	---------	---

CONTENTS / CONTENIDO  
1 - 23788/093 - 3" Knife / Cuchillo 3"  
1 - 23789/070 - Fork / Tenedor  
1 - 23790/020 - Spoon / Cuchara

NEW | NUEVO

+12m



### Plate / Plato - ø 20 cm

23777/120	12	1,89	0,015	29940.5	1
-----------	----	------	-------	---------	---

NEW | NUEVO

+12m



### Plate / Plato - ø 20 cm

23777/130	12	1,89	0,015	29941.2	1
-----------	----	------	-------	---------	---

NEW | NUEVO

+36m



### 5 pcs. Children's set / Juego infantil 5 pzas.

23797/001	05	2,39	0,045	29949.8	5
-----------	----	------	-------	---------	---

CONTENTS / CONTENIDO  
1 - 23777/020 - Plate / Plato - ø 20 cm  
1 - 23779/020 - 260 ml Cup / Vaso 260 ml  
1 - 23788/093 - 3" Knife / Cuchillo 3"  
1 - 23789/070 - Fork / Tenedor  
1 - 23790/020 - Spoon / Cuchara

# MIX COLOR



## THEY ORGANIZE THE ROUTINE WITH LIGHTNESS. | ORGANIZAN LA RUTINA CON LIGEREZA.

A line that breaks the monochrome to get rid of the monotony. With different colors and sizes, in addition to facilitating storage, conservation, organization and preparation of food or ingredients, the Mixcolor Tramontina line made these tasks lighter and more practical by bringing cheerful tones into the home.

Una línea que rompe con la monocromía para acabar con la monotonía. Con diferentes colores y tamaños, además de facilitar el almacenamiento, la conservación, la organización y la preparación de los alimentos o los ingredientes, la línea Mixcolor Tramontina mejoró estas tareas y las volvió más prácticas al incorporar tonos alegres al hogar.



prepare  
preparar



server  
servir



store  
guardar

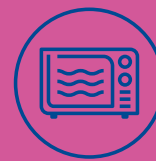

microwave-safe  
microondas



freezer-safe  
freezer



dishwasher  
lavavajillas

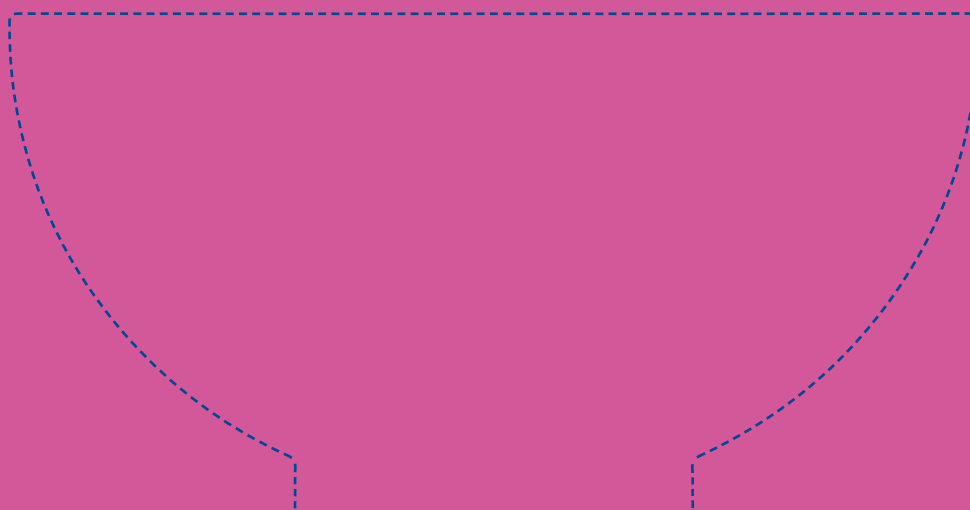









## MIX COLOR

- polypropylene containers and lids |  
potes y tapas de polipropileno
- transparent lids | tapas transparentes



watch the video



vea el vídeo



### 3 pcs. Containers set / Juego de potes 3 pzas.

Ref.	un.	Kg	m <sup>3</sup>	789.1112.	packaging empaques
25099/979	04	2,40	0,041	26666.7	

#### CONTENTS / CONTENIDO

3 - 600 ml Containers / Potes 600 ml



### 3 pcs. Containers set / Juego de potes 3 pzas.

25099/980	04	4,12	0,039	26667.4	
-----------	----	------	-------	---------	--

#### CONTENTS / CONTENIDO

1 - 600 ml Container / Pote 600 ml

1 - 2 L Container / Pote 2 L

1 - 4 L Container / Pote 4 L



### 300 ml Container / Pote 300 ml

25099/975	20	1,79	0,018	26662.9	
-----------	----	------	-------	---------	--

#### CONTENTS / CONTENIDO

(master box / caja master)

4 - Pink / Rosa

4 - Yellow / Amarillo

4 - Blue / Azul

4 - Purple / Púrpura

4 - Red / Rojo



### 600 ml Container / Pote 600 ml

25099/976	12	1,80	0,023	26663.6	
-----------	----	------	-------	---------	--

#### CONTENTS / CONTENIDO

(master box / caja master)

4 - Blue / Azul

4 - Pink / Rosa

4 - Yellow / Amarillo



### 2 L Container / Pote 2 L

25099/977	09	2,89	0,037	26664.3	
-----------	----	------	-------	---------	--

#### CONTENTS / CONTENIDO

(master box / caja master)

3 - Blue / Azul

3 - Pink / Rosa

3 - Yellow / Amarillo



#### 4 L Container / Pote 4 L

Ref.	un.	Kg	m <sup>3</sup>	789.1112.	packaging empaque
25099/978	06	2,98	0,046	26665.0	●

CONTENTS / CONTENIDO  
 (master box / caja master)  
 2 - Blue / Azul  
 2 - Pink / Rosa  
 2 - Yellow / Amarillo



#### 9 pcs. Ice cream set / Juego para helados 9 pzas.

25099/942	04	3,12	0,043	23031.6	■
-----------	----	------	-------	---------	---

CONTENTS / CONTENIDO  
 4 - 300 ml Bowls / Copas 300 ml  
 4 - Dessert spoons / Cucharas postre  
 1 - Ice cream scoop / Cuchara para helado



#### 12 pcs. Dessert set / Juego para postre 12 pzas.

25099/943	04	3,48	0,044	23032.3	■
-----------	----	------	-------	---------	---

CONTENTS / CONTENIDO  
 6 - 300 ml Bowls / Copas 300 ml  
 6 - Dessert spoons / Cucharas postre



watch the video



vea el vídeo

#### 5 pcs. Cutting boards set with holder / Juego de tablas con soporte 5 pzas.

25099/940	04	6,61	0,029	22843.6	■
-----------	----	------	-------	---------	---

CONTENTS / CONTENIDO  
 1 - 25053/770 - Cutting board for raw meat / Tabla de corte para carnes crudas  
 1 - 25053/710 - Cutting board for fish / Tabla de corte para pescado  
 1 - 25053/720 - Cutting board for vegetables / Tabla de corte para legumbres y vegetables  
 1 - 25053/780 - Cutting board for bread and cheese / Tabla de corte para panes y quesos  
 1 - 29900/507 - Holder / Soporte

#### Cutting Board / Tabla para cortar (29x20 cm)

■ 25053/170	12	3,86	0,006	20850.6	●
□ 180				20851.3	



# STAR FLON

**UNLIKE THE FOOD, THE OWNERS STICK TO A STARFLON. | A DIFERENCIA DE LA COMIDA, LOS DUEÑOS NUNCA SE DESPEGAN DE UNA STARFLON.**

Good nonstick is one that, from Monday to Monday, does not let the food stick to the pan. And if it does not stick, you can be sure that the pan is a Starflon Tramontina. Produced to be a practical and healthy alternative, Starflon coating provides greater durability to the product and is PFOA-free, in addition to being easy to sanitize and offer models in different finishes and colors to shine in all recipes.

Un buen antiadherente es aquel que, de un segundo al otro, no deja que los alimentos se peguen en la olla. Y si no se pegan, puede estar seguro de que la olla es una Tramontina Starflon. Producido para ser una alternativa práctica y saludable, el revestimiento Starflon proporciona mayor durabilidad al producto y está libre de PFOA, además de ser fácil de limpiar y con modelos en diferentes acabados y colores, para brillar en todas las recetas.



Nonstick  
No se pega



Easy to clean  
Fácil de limpiar



Healthier  
Más saludable



More durable  
Más durable



PFOA free  
Libre de PFOA



ANTIADERENTE  
NONSTICK  
★★★  
**STARFLON®**  
**MAX**

**3X MAIS  
DURÁVEL**  
3X LONGER LASTING • 3X MÁS DURABLE

ANTIADERENTE  
NONSTICK  
★★★★★  
**STARFLON®**  
**EXCELLENT**

**5X MAIS  
DURÁVEL**  
5X LONGER LASTING • 5X MÁS DURABLE

ANTIADERENTE  
NONSTICK  
★★★★★★★★  
**STARFLON®**  
**PREMIUM**

**10X MAIS  
DURÁVEL**  
10X LONGER LASTING • 10X MÁS DURABLE

ANTIADERENTE  
NONSTICK  
★★★★★★★★★★  
**STARFLON®**  
**HIGH  
PERFORMANCE**

**20X MAIS  
DURÁVEL**  
20X LONGER LASTING • 20X MÁS DURABLE

# STAR FLON MAX

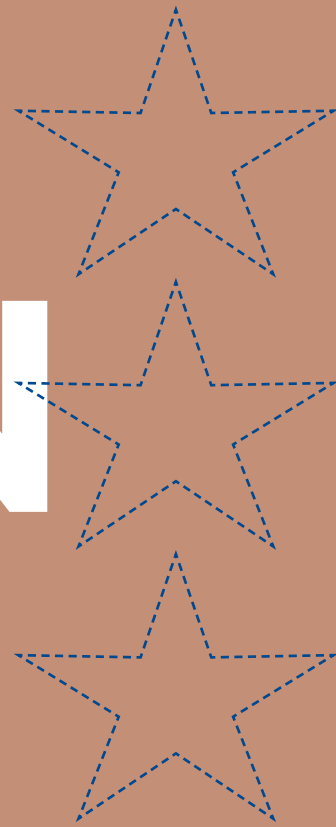

**ESSENTIAL FOR ALL KITCHENS. AND ALL COOKS. | ESENCIAL PARA TODAS LAS COCINAS. Y TODOS LOS COCINEROS.**

- 196.** *Brasil*
- 199.** *Vermont*
- 201.** *Turim*
- 204.** *Loreto*
- 211.** *Paris*
- 220.** *Vermont*
- 223.** *Kettles /  
Teteras*

Ideal for those who want practicality and versatility for everyday recipes. From Brazilian doughnuts to fluffy rice, the Starflon Max nonstick coated pans ensure quick and even cooking of food.

Ideal para quienes quieren practicidad y versatilidad para las recetas del día a día. Desde las croquetas hasta el arroz suelto, las ollas con revestimiento antiadherente Starflon Max garantizan una cocción rápida y uniforme de los alimentos.



Nonstick  
No se pega



Easy to clean  
Fácil de limpiar



Healthier  
Más saludable



More durable  
Más durable



PFOA free  
Libre de PFOA





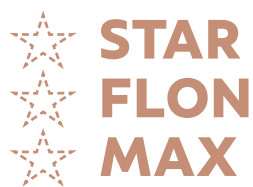

## Brasil

- aluminum with interior and exterior Starflon Max nonstick coating | alumínio com revestimento interno y externo antiaderente Starflon Max
- dishwasher safe | resistente a lavavajillas



### Colors | Cores



graphite | grafito  
8625c



red | rojo  
7628c

#### Deep roasting pan / Asadera rectangular honda - 22, 28, 34, 40 cm



Ref.	un.	Kg	m <sup>3</sup>	thick espesor mm	lit.	size tamaño cm	789.1112.	packaging empaque
20051/022		1,32	0,008	0,8	1,9	27,3x20x5,4	05889.7	●
722							15287.8	
028		1,87	0,012	0,8	3,3	33,3x24,1x6,2	05890.3	
728	06						15856.6	
034		2,61	0,017	0,8	4,9	39,2x28,2x6,3	05891.0	
734							15857.3	
040		3,38	0,024	0,8	7,2	45,2x32,3x6,8	05892.7	
740							19245.4	

#### Flat roasting pan / Asadera rectangular rasa - 22, 28, 34, 40 cm



20053/022		1,24	0,008	0,8	1,4	27,3x20x3,5	05897.2	●
722							15288.5	
028		1,61	0,012	0,8	2,0	33,3x24,1x3,5	05898.9	
728	06						19247.8	
034		2,14	0,012	0,8	2,9	39,2x28,2x3,5	05899.6	
734							15833.7	
040		2,83	0,019	0,8	3,8	45,3x32,3x3,5	05900.9	
740							19250.8	



#### Deep roasting pan with grill / Asadera rectangular con rejilla - 34 cm

20048/034	06	6,02	0,059	0,8	4,9	39,2x28,2x6,3	20517.8	□
734							20519.2	



#### Baking pan with removable bottom / Molde para tarta desmontable - ø 24 cm

20064/024	06	1,68	0,010	1,0	1,4	24x4,1	20506.2	■
724							20508.6	



### Baking pan / Molde para tarta - ø 24, 26 cm



Ref.	un.	Kg	m <sup>3</sup>	esp. mm	lit.	medida cm	789.1112. apresentação
■ 20056/024	06	1,39	0,008	1,0	1,4	24x4	01596.8
■ 724						19259.1	
■ 026		1,57	0,009	1,0	1,8	26x4,2	01597.5
■ 726						15289.2	

### Pizza pan / Asadera para pizza - ø 30, 35 cm



■ 20058/030	06	1,82	0,010	0,8	1,8	30x2,8	04835.5
■ 730						15291.5	
■ 035		2,69	0,014	1,0	2,5	35x3,0	02159.4
■ 735						19264.5	

### Pizza pan with holes / Asadera para pizza perforada - ø 30 cm



■ 20076/030	06	1,49	0,011	0,8	-	30x1,8	24799.4
■ 730						24803.8	

### Round baking pan / Molde para hornear - ø 22, 24, 26 cm



■ 20057/022	06	1,27	0,007	0,8	1,7	22x5,0	02160.0
■ 722						15834.4	
■ 024		1,50	0,009	0,8	2,1	24x5,0	02161.7
■ 724						15290.8	
■ 026						1,65	0,011
■ 726	19262.1						

### Cake pan / Molde para rosca - ø 24 cm



■ 20060/024	06	2,39	0,031	1,0	1,4	24x5,6	01622.4
■ 724						15292.2	

### Cake pan / Molde para rosca - ø 24 cm



■ 20074/024	06	2,63	0,041	1,0	2,0	24x6,5	24698.0
■ 724						24699.7	

### Brioche mold / Molde para brioche - ø 22 cm



■ 20065/022	06	1,48	0,011	1,0	1,3	22x9,5	01566.1
■ 722						19110.5	

### Cake mold / Molde para tarta - 24 cm



■ 20075/024	06	0,99	0,005	1,0	1,1	23x19,5x5,4	24700.0
■ 724						24701.7	



**Cake pan with removable bottom /  
Molde para tarta desmontable - ø 26 cm**

Ref.	un.	Kg	m <sup>3</sup>	thick espesor mm	lit.	size tamaño cm	789.1112.	packaging empaque
■ 20066/026	06	4,06	0,050	1,0	3,3	26x7,5	05905.4	■
■ 726					2,8			



**Bread mold / Molde para pan - 22, 26, 30 cm**

■ 20069/022	06	1,20	0,005	1,0	1,2	25,9x12,5x7	02163.1	●
■ 722							19269.0	
■ 026	06	1,37	0,006	1,0	1,4	29,8x12,5x7	02164.8	●
■ 726							15293.9	
■ 030	06	1,60	0,008	1,0	1,9	33,5x13,1x7	04926.0	●
■ 730							19111.2	



**3 pcs. Roasting pan set / Juego de asaderas 3 pzas.**

Ref.	un.	Kg	m <sup>3</sup>	789.1112.	packaging empaque
■ 20099/020	06	6,94	0,058	06997.8	■
■ 720				19272.0	

**CONTENTS / CONTENIDO**

- 1 - 20051/722 - Deep roasting pan / Asadera rectangular honda - 22 cm (1,9 L)
- 1 - 20051/728 - Deep roasting pan / Asadera rectangular honda - 28 cm (3,3 L)
- 1 - 20051/734 - Deep roasting pan / Asadera rectangular honda - 34 cm (4,9 L)



**3 pcs. Cake set / Portatorta 3 pzas.**

29899/063	06	3,67	0,048	23009.5	○
-----------	----	------	-------	---------	---

**CONTENTS / CONTENIDO**

- 1 - Cake plate / Plato
- 1 - Lid / Tapa
- 1 - 25164/000 - Cake server / Espátula para torta



**Cake and pudding pan / Budinera - ø 20 cm**

Ref.	un.	Kg	m <sup>3</sup>	thick espesor mm	lit.	size tamaño cm	789.1112.	packaging empaque
■ 20062/020	06	1,60	0,010	1,2	1,5	20x9,3	06995.4	■



**Cake and pudding pan / Budinera - ø 24 cm**

■ 20062/024	06	2,20	0,012	1,2	2,6	24x8,6	03475.4	■
-------------	----	------	-------	-----	-----	--------	---------	---



## Vermont

- aluminum with interior Starflon Max nonstick coating | aluminio con revestimiento interno antiaderente Starflon Max
- exterior polyester or nonstick coating | revestimiento externo de poliéster o antiaderente



### Deep roasting pan / Asadera rectangular honda - 22, 28, 34 cm

Exterior polyester coating / Revestimiento externo de poliéster



Ref.	un.	Kg	m <sup>3</sup>	thick espesor mm	lit.	size tamaño cm	789.1112	packaging empaque
27806/001		1,31	0,008	0,8	1,9	27,3x20x5,4	24877.9	
002	06	1,97	0,013	0,8	3,3	33,3x24,1x6,2	24878.6	●
003		2,60	0,017	0,8	4,9	39,2x28,2x6,3	24879.3	

### Baking mold / Molde para tarta - ø 26 cm

Exterior polyester coating / Revestimiento externo de poliéster



27806/004	06	1,60	0,009	1,0	1,8	26x4,2	24880.9	●
-----------	----	------	-------	-----	-----	--------	---------	---

### Pizza pan / Asadera para pizza - ø 35 cm

Exterior polyester coating / Revestimiento externo de poliéster



27806/005	06	2,85	0,017	1,0	2,5	35x3,0	24881.6	●
-----------	----	------	-------	-----	-----	--------	---------	---

### Cake pan / Molde para rosca - ø 24 cm

Exterior Starflon nonstick coating /  
Revestimiento externo de antiaderente Starflon



27806/006	06	1,52	0,011	1,0	1,4	24x5,8	24882.3	■
-----------	----	------	-------	-----	-----	--------	---------	---

### Cake pan with removable bottom / Molde para tarta desmontable - ø 26 cm



27806/007	06	4,18	0,053	1,0	3,3 2,8	26x7,5	24883.0	■
-----------	----	------	-------	-----	------------	--------	---------	---





**Bread mold / Molde para pan - 26 cm**

Exterior Starflon nonstick coating /  
Revestimiento externo de antiadherente Starflon

Ref.	un.	Kg	m <sup>3</sup>	thick espesor mm	lit.	size tamaño cm	789.1112.	packaging empaquet
27806/008	06	1,35	0,006	1,0	1,4	29,8x12,5x7	24884.7	



**Cake pan / Molde para rosca - ø 24 cm**

Exterior Starflon nonstick coating /  
Revestimiento externo de antiadherente Starflon

27806/009	06	2,63	0,038	1,0	2,0	24x6,5	24885.4	
-----------	----	------	-------	-----	-----	--------	---------	--



**6 pcs. Tart molds set / Juego de moldes para tartaletas 6 pzas.**

Exterior polyester coating / Revestimiento externo de poliéster

Ref.	un.	Kg	m <sup>3</sup>	789.1112.	packaging empaquet
27899/039	06	1,44	0,005	24905.9	

CONTENTS / CONTENIDO

6 - 27806/028 - Tart molds / Torteras - ø 10 cm



**3 pcs. Roasting pan set / Juego de asaderas 3 pzas.**

Exterior polyester coating / Revestimiento externo de poliéster

27899/038	06	6,80	0,058	24904.2	
-----------	----	------	-------	---------	--

CONTENTS / CONTENIDO

1 - 27806/001 - Deep roasting pan / Asadera honda - 22 cm (1,9 L)

1 - 27806/002 - Deep roasting pan / Asadera honda - 28 cm (3,3 L)

1 - 27806/003 - Deep roasting pan / Asadera honda - 34 cm (4,9 L)

# STARFLON MAX



gas  
gas



electric  
eléctrica



ceramic glass (electric  
heating element)  
vitrocerámico  
(resistencia eléctrica)

## Turim

- aluminum with interior and exterior Starflon Max nonstick coating | aluminio con revestimiento interno y externo antiaderente Starflon Max
- heat-resistant bakelite handles and nylon knobs | mangos y asas de baquelita antitérmica y agarradores de nylon
- tempered glass lids with stainless steel rims | tapas de vidrio templado con bordes de acero inoxidable
- dishwasher safe | resistente a lavavajillas



### Colors | Colores



dark grey | plomo  
431c



red | rojo  
7628c



#### Egg frying pan / Sartén para huevo - ø 13 cm

Ref.	un.	Kg	m <sup>3</sup>	thick espesor mm	lit.	size tamaño cm	789.1112	packaging empaque
20182/013	12	2,20	0,024	1,2	0,4	ø 13	12758.6	



#### Frying pan / Sartén - ø 16 cm

20188/016	12	3,60	0,036	1,2	0,5	ø 16	12760.9	
-----------	----	------	-------	-----	-----	------	---------	--



#### Egg-poaching pan / Olla para huevo poché - ø 10 cm

20275/610	06	1,74	0,013	2,0	0,3	ø 10	22811.5	
-----------	----	------	-------	-----	-----	------	---------	--



#### Frying Pan / Sartén - ø 16, 18, 20, 22, 24, 26, 28, 30 cm

■ 20260/616		2,49	0,027	1,2	0,4	ø 16	20090.6	
■ 716							19513.4	
■ 618		3,00	0,046	1,2	0,7	ø 18	20175.0	
■ 718							19514.1	
■ 620		3,40	0,042	1,2	0,8	ø 20	19727.5	
■ 720							19129.7	
■ 622		3,76	0,052	1,2	1,0	ø 22	19728.2	
■ 722	12						21355.5	
■ 624		4,40	0,058	1,2	1,4	ø 24	20178.1	
■ 724							20179.8	
■ 626		4,90	0,073	1,2	1,8	ø 26	21155.1	
■ 726							24073.5	
■ 628		5,60	0,087	1,2	2,0	ø 28	21156.8	
■ 728							24117.6	
■ 630		6,00	0,091	1,2	2,5	ø 30	21158.2	
■ 730							24074.2	



**Pancake mold / Panquequera - ø 22 cm**

Ref.	un.	Kg	m <sup>3</sup>	thick espesor mm	lit.	size tamaño cm	789.1112.	packaging empaque
■ 20264/622	12	4,11	0,038	1,6	0,6	ø 22	20132.3	●
■ 722								



**Stockpot / Cuscusera - ø 14 cm**

■ 20268/614	04	3,06	0,034	1,6	1,9	ø 14	21881.9	●
■ 714								

NEW | NUEVO



**Stock pot / Cuscusera - ø 16 cm**

■ 20266/616	04	4,16	0,047	1,4	1,8	ø 16	25293.6	●
■ 716								



**Casserole / Cacerola - ø 18, 20, 22, 24 cm**

■ 20261/618	04	3,13	0,028	1,2	2,0	ø 18	21421.7	●	
■ 718									19515.8
■ 620		3,80	0,034	1,2	2,8	ø 20	19130.3		
■ 720									19131.0
■ 622									4,15
■ 722		19720.6							
■ 624		4,92	0,054	1,2	4,9	ø 24	19729.9		
■ 724	20402.7								



**Sauce pan / Olla - ø 16, 18, 20 cm**

■ 20262/616	04	2,62	0,023	1,2	1,4	ø 16	19360.4	●	
■ 716									19361.1
■ 618		3,18	0,029	1,2	2,0	ø 18	19132.7		
■ 718									19133.4
■ 620									3,74
■ 720		21713.3							

NEW | NUEVO



**Milk boiler / Hervidor leche - ø 12, 14 cm**

■ 20332/612	06	1,97	0,018	1,4	1,0	ø 12	19134.1	●
■ 712								
■ 614		2,40	0,027	1,4	1,7	ø 14	19726.8	
■ 714								



**2 pcs. Frying pan set / Juego de sartenes 2 pzas.**

Ref.	un.	Kg	m <sup>3</sup>	789.1112.	packaging empaque
20198/660	06	2,76	0,034	21150.6	●
760				21151.3	

**CONTENTS / CONTENIDO**

- 1 - 20260/616 - Frying pan / Sartén - ø 16 cm (0,4 L)
- 1 - 20260/620 - Frying pan / Sartén - ø 20 cm (0,8 L)



**3 pcs. Frying pan set / Juego de sartenes 3 pzas.**

20198/661	06	4,80	0,056	21152.0	●
761				21153.7	

**CONTENTS / CONTENIDO**

- 1 - 20260/616 - Frying pan / Sartén - ø 16 cm (0,4 L)
- 1 - 20260/620 - Frying pan / Sartén - ø 20 cm (0,8 L)
- 1 - 20260/624 - Frying pan / Sartén - ø 24 cm (1,4 L)



**5 pcs. Cookware set / Bateria de cocina 5 pzas.**

20298/661	03	10,66	0,135	26723.7	■
761				19128.0	

**CONTENTS / CONTENIDO**

- 1 - 20260/620 - Frying pan / Sartén - ø 20 cm (0,8 L)
- 1 - 20261/620 - Casserole / Cacerola - ø 20 cm (2,8 L)
- 1 - 20262/616 - Sauce pan / Olla - ø 16 cm (1,4 L)
- 1 - 20262/618 - Sauce pan / Olla - ø 18 cm (2,0 L)
- 1 - 20332/612 - Milk boiler / Hervidor - ø 12 cm (1,0 L)



**7 pcs. Cookware set / Bateria de cocina 7 pzas.**

20298/664	03	14,00	0,135	20312.9	■
764				19719.0	

**CONTENTS / CONTENIDO**

- 1 - 20260/616 - Frying pan / Sartén - ø 16 cm (0,4 L)
- 1 - 20260/620 - Frying pan / Sartén - ø 20 cm (0,8 L)
- 1 - 20261/620 - Casserole / Cacerola - ø 20 cm (2,8 L)
- 1 - 20261/622 - Casserole / Cacerola - ø 22 cm (3,7 L)
- 1 - 20262/616 - Sauce pan / Olla - ø 16 cm (1,4 L)
- 1 - 20262/618 - Sauce pan / Olla - ø 18 cm (2,0 L)
- 1 - 20332/612 - Milk boiler / Hervidor - ø 12 cm (1,0 L)



# STARFLON MAX



gas  
gas



electric  
eléctrica



ceramic glass (electric  
heating element)  
vitrocerámico  
(resistencia eléctrica)

## Loreto

- aluminum with interior and exterior Starflon Max nonstick coating | aluminio con revestimiento interno y externo antiaderente Starflon Max
- heat-resistant bakelite handles and nylon knobs | mangos, asas de baquelita antitérmica y agarradores de nylon
- tempered glass lids with stainless steel rim | tapas de vidrio templado con bordes de acero inoxidable
- dishwasher safe | resistente a lavavajillas



### Colors | Colores



graphite | grafito  
8625c



red | rojo  
7628c

### Frying pan / Sartén - ø 16, 18, 20, 22, 24, 26, 28, 30 cm



Ref.	un.	Kg	m <sup>3</sup>	thick espesor mm	lit.	size tamaño cm	789.1112	packaging empaquete
20380/016		2,78	0,028	1,6	0,4	ø16	26566.0	●
018		3,58	0,041	1,6	0,7	ø18	26568.4	
020		3,74	0,041	1,6	0,8	ø20	26569.1	
022	12	4,89	0,059	1,6	1,1	ø22	26570.7	
024		5,05	0,057	1,6	1,4	ø24	26571.4	
026		5,93	0,078	1,6	1,8	ø26	26572.1	
028		6,63	0,087	1,6	2,0	ø28	26573.8	
030		7,07	0,093	1,6	2,5	ø30	26574.5	



### Skillet grill / Bifera - 26 cm

20391/024	06	4,50	0,045	2,3	1,3	29,1x26,4	26610.0	■
-----------	----	------	-------	-----	-----	-----------	---------	---



Glass Ceramic  
(electric heating element)  
Vitrocerámico  
(resistencia eléctrica)



### Skillet grill / Bifera - 26 cm

Exterior silicone coating / Revestimiento externo siliconado

20392/024	06	4,50	0,045	2,3	1,0	29,1x26,4	26612.4	■
-----------	----	------	-------	-----	-----	-----------	---------	---



### Pancake mold / Panquequera - ø 22 cm

20389/022	12	4,12	0,036	1,6	0,6	ø22	26607.0	●
-----------	----	------	-------	-----	-----	-----	---------	---





**Skillet grill / Bifera - ø 22 cm**

Exterior silicone coating / Revestimiento externo siliconado

Ref.	un.	Kg	m <sup>3</sup>	thick espesor mm	lit.	size tamaño cm	7891112.	packaging empaque
20390/022	12	4,12	0,036	1,6	0,6	ø 22	26608.7	■



Superior: 0,9 L



**Omelette pan / Omeletera - ø 20 cm**

20123/020	06	3,04	0,033	1,2	0,8 0,9	ø 20	12167.6	■
-----------	----	------	-------	-----	------------	------	---------	---

Bottom pan / Inferior: 0,8 L

Superior:  
ø 20 cm (0,5 L)  
ø 24 cm (0,9 L)



**Omelette pan / Omeletera - ø 20, 24 cm**

20687/020	06	3,40	0,025	1,6	0,5 0,7	ø 20	16906.7	■
024		4,60	0,039	1,6	0,9 1,1	ø 24	16907.4	

Bottom pan / Inferior:  
ø 20 cm (0,7 L)  
ø 24 cm (1,1 L)

**NEW | NUEVO**



**Wok / Wok - ø 28 cm**

20395/028	06	3,72	0,070	1,4	3,60	ø 28	28852.2	●
-----------	----	------	-------	-----	------	------	---------	---



**Wok / Wok - ø 32, 36 cm**

20252/032	06	6,45	0,096	2,0	4,4	ø 32	08255.7	●
036		7,58	0,112	2,0	6,0	ø 36	09120.7	

**NEW | NUEVO**



**Deep frying pan / Sartén honda - ø 24 cm**

20385/024	06	3,04	0,027	1,8	2,2	ø 24	31461.0	■
-----------	----	------	-------	-----	-----	------	---------	---



**Paella pan / Paellera - ø 30, 34, 38 cm**

■ 20125/030		4,60	0,021	2,3	2,5	ø 30	04761.7	●
■ 034	06	5,64	0,026	2,3	3,7	ø 34	04762.4	
■ 038		7,21	0,033	2,3	5,4	ø 38	04763.1	



**Casserole / Cacerola - ø 20, 22, 24 cm**

Ref.	un.	Kg	m <sup>3</sup>	thick espesor mm	lit.	size tamaño cm	789.1112.	packaging empaque
20382/020		3,98	0,035	1,6	2,8	ø 20	26597.4	
022	04	4,64	0,044	1,6	3,7	ø 22	26598.1	●
024		5,91	0,056	1,6	4,9	ø 24	26599.8	



**Sauce pan / Olla - ø 16, 18, 20 cm**

20383/016		2,78	0,022	1,6	1,4	ø 16	26601.8	
018	04	3,38	0,030	1,6	2,0	ø 18	26602.5	●
020		4,19	0,040	1,6	2,8	ø 20	26603.2	



**Milk boiler / Hervidor - ø 12, 14 cm**

20384/012		1,95	0,018	1,4	1,0	ø 12	26605.6	
014	06	2,57	0,026	1,4	1,7	ø 14	26668.1	●



check out the product  
in augmented reality /  
vea el producto en  
realidad aumentada

NEW | NUEVO



**Popcorn maker / Olla para palomitas de maiz - ø 20 cm**

20387/020	04	5,94	0,075	1,6	3,5	ø 20	31186.2	■
-----------	----	------	-------	-----	-----	------	---------	---



**2 pcs. Frying pan set / Juego de sartenes 2 pzas.**

Ref.	un.	Kg	m <sup>3</sup>	789.1112.	packaging empaque
20399/080	06	4,41	0,049	26698.8	●

**CONTENTS / CONTENIDO**

- 1 - 20380/020 - Frying pan / Sartén - ø 20 cm (0,8 L)
- 1 - 20380/024 - Frying pan / Sartén - ø 24 cm (1,4 L)



**3 pcs. Frying pan set / Juego de sartenes 3 pzas.**

20399/081	06	4,24	0,048	26699.5	▲
-----------	----	------	-------	---------	---

**CONTENTS / CONTENIDO**

- 1 - 20380/018 - Frying pan / Sartén - ø 18 cm (0,7 L)
- 1 - 20380/022 - Frying pan / Sartén - ø 22 cm (1,1 L)
- 1 - 25130/060 - Spatula / Espátula



**5 pcs. Cookware set / Batería de cocina 5 pzas.**

Ref.	un.	Kg	m <sup>3</sup>	789.1112.	packaging empaque
20399/082	03	11,40	0,114	26701.5	

**CONTENTS / CONTENIDO**

- 1 - 20380/020 - Frying pan / Sartén - ø 20 cm (0,8 L)
- 1 - 20382/020 - Casserole / Cacerola - ø 20 cm (2,8 L)
- 1 - 20383/016 - Sauce pan / Olla - ø 16 cm (1,4 L)
- 1 - 20383/018 - Sauce pan / Olla - ø 18 cm (2,0 L)
- 1 - 20384/012 - Milk boiler / Hervidor - ø 12 cm (1,0 L)



**7 pcs. Cookware set / Batería de cocina 7 pzas.**

20399/083	03	15,85	0,165	26700.8	
-----------	----	-------	-------	---------	--

**CONTENTS / CONTENIDO**

- 1 - 20380/020 - Frying pan / Sartén - ø 20 cm (0,8 L)
- 1 - 20381/022 - Straight frying pan / Sartén recta - ø 22 cm (1,7 L)
- 1 - 20382/020 - Casserole / Cacerola - ø 20 cm (2,8 L)
- 1 - 20382/022 - Casserole / Cacerola - ø 22 cm (3,7 L)
- 1 - 20383/016 - Sauce pan / Olla - ø 16 cm (1,4 L)
- 1 - 20383/018 - Sauce pan / Olla - ø 18 cm (2,0 L)
- 1 - 20384/014 - Milk boiler / Hervidor - ø 14 cm (1,7 L)

**Frying pan / Sartén - ø 16, 18, 20, 22, 24, 26, 28, 30 cm**

Ref.	un.	Kg	m <sup>3</sup>	thick espesor mm	lit.	size tamaño cm	789.1112.	packaging empaque
20380/716		2,78	0,028	1,6	0,4	ø 16	26566.7	
718		3,58	0,041	1,6	0,7	ø 18	22845.0	
720		3,74	0,041	1,6	0,8	ø 20	22847.4	
722	12	4,89	0,058	1,6	1,1	ø 22	22849.8	
724		5,05	0,057	1,6	1,4	ø 24	22851.1	
726		5,93	0,078	1,6	1,8	ø 26	25448.0	
728		6,63	0,087	1,6	2,0	ø 28	25576.0	
730		7,07	0,093	1,6	2,5	ø 30	26575.2	



**Skillet grill / Bifera - 26 cm**

20391/724	06	4,50	0,045	2,3	1,3	29,1x26,7	26611.7	
-----------	----	------	-------	-----	-----	-----------	---------	--



**Skillet grill / Bifera - 26 cm**

Exterior silicone coating / Revestimiento externo siliconado

20392/724	06	4,50	0,045	2,3	1,0	29,1x26,4	26613.1	
-----------	----	------	-------	-----	-----	-----------	---------	--





**Pancake mold / Panquequera - ø 22 cm**

Ref.	un.	Kg	m³	thick espesor mm	lit.	size tamaño cm	789.1112.	packaging empaque
20389/722	12	4,12	0,036	1,6	0,6	ø 22	25173.1	



**Skillet grill / Bifera - ø 22 cm**

Exterior silicone coating / Revestimiento externo siliconado

20390/722	12	4,12	0,036	1,6	0,6	ø 22	26609.4	
-----------	----	------	-------	-----	-----	------	---------	--



Superior: 0,9 L



Bottom pan / Inferior: 0,8 L

**Omelette pan / Omeletera - ø 20 cm**

20123/920	06	3,26	0,033	1,2	0,8 0,9	ø 20	26669.8	
-----------	----	------	-------	-----	------------	------	---------	--

Superior:  
ø 20 cm (0,5 L)  
ø 24 cm (0,9 L)



Bottom pan / Inferior:  
ø 20 cm (0,7 L)  
ø 24 cm (1,1 L)

**Omelette pan / Omeletera - ø 20, 24 cm**

20687/720	06	3,40	0,025	1,6	0,5 0,7	ø 20	26618.6	
724		4,60	0,039	1,6	0,9 1,1	ø 24	26619.3	

**NEW | NUEVO**



**Wok / Wok - ø 28 cm**

20395/728	06	3,72	0,070	1,40	3,60	ø 28	28853.9	
-----------	----	------	-------	------	------	------	---------	--



**Wok / Wok - ø 32, 36 cm**

20252/732	06	6,02	0,101	2,0	4,4	ø 32	26616.2	
736		7,58	0,112	2,0	6,0	ø 36	26617.9	

NEW | NUEVO



**Deep frying pan / Sartén honda - Ø 24 cm**

Ref.	un.	Kg	m <sup>3</sup>	thick espesor mm	lit.	size tamaño cm	789.1112.	packaging empaque
20385/724	06	3,04	0,027	1,8	2,2	Ø 24	31462.7	■



**Casserole / Cacerola - Ø 20, 22, 24 cm**

20382/720		3,98	0,034	1,6	2,8	Ø 20	22856.6	●
722	04	4,64	0,044	1,6	3,7	Ø 22	22858.0	
724		5,91	0,056	1,6	4,9	Ø 24	26600.1	



**Sauce pan / Olla - Ø 16, 18, 20 cm**

20383/716		2,78	0,022	1,6	1,4	Ø 16	26860.3	●
718	04	3,38	0,030	1,6	2,0	Ø 18	26862.7	
720		4,19	0,040	1,6	2,8	Ø 20	26604.9	



**Milk boiler / Hervidor - Ø 12, 14 cm**

20384/712		1,95	0,018	1,4	1,0	Ø 12	22864.1	●
714	06	2,57	0,026	1,4	1,7	Ø 14	22866.5	



check out the product  
in augmented reality /  
vea el producto en  
realidad aumentada



NEW | NUEVO



**Popcorn maker / Olla para palomitas de maíz - Ø 20 cm**

20387/720	04	5,94	0,075	1,6	3,5	Ø 20	31187.9	●
-----------	----	------	-------	-----	-----	------	---------	---





**2 pcs. Frying pan set / Juego de sartenes 2 pzas.**

Ref.	un.	Kg	m <sup>3</sup>	789.1112.	packaging empaque
20399/780	06	4,41	0,049	22868.9	

CONTENTS / CONTENIDO  
 1 - 20380/720 - Frying pan / Sartén - ø 20 cm (0,8 L)  
 1 - 20380/724 - Frying pan / Sartén - ø 24 cm (1,4 L)



**3 pcs. Frying pan set / Juego de sartenes 3 pzas.**

20399/781	06	4,24	0,048	22870.2	
-----------	----	------	-------	---------	--

CONTENTS / CONTENIDO  
 1 - 20380/718 - Frying pan / Sartén - ø 18 cm (0,7 L)  
 1 - 20380/722 - Frying pan / Sartén - ø 22 cm (1,1 L)  
 1 - 25130/060 - Spatula / Espátula



**5 pcs. Cookware set / Batería de cocina 5 pzas.**

20399/782	03	11,40	0,114	22872.6	
-----------	----	-------	-------	---------	--

CONTENTS / CONTENIDO  
 1 - 20380/720 - Frying pan / Sartén - ø 20 cm (0,8 L)  
 1 - 20382/720 - Casserole / Cacerola - ø 20 cm (2,8 L)  
 1 - 20383/716 - Sauce pan / Olla - ø 16 cm (1,4 L)  
 1 - 20383/718 - Sauce pan / Olla - ø 18 cm (2,0 L)  
 1 - 20384/712 - Milk boiler / Hervidor - ø 12 cm (1,0 L)



**7 pcs. Cookware set / Batería de cocina 7 pzas.**

20399/783	03	15,85	0,165	23058.3	
-----------	----	-------	-------	---------	--

CONTENTS / CONTENIDO  
 1 - 20380/720 - Frying pan / Sartén - ø 20 cm (0,8 L)  
 1 - 20381/722 - Straight frying pan / Sartén recta - ø 22 cm (1,7 L)  
 1 - 20382/720 - Casserole / Cacerola - ø 20 cm (2,8 L)  
 1 - 20382/722 - Casserole / Cacerola - ø 22 cm (3,7 L)  
 1 - 20383/716 - Sauce pan / Olla - ø 16 cm (1,4 L)  
 1 - 20383/718 - Sauce pan / Olla - ø 18 cm (2,0 L)  
 1 - 20384/714 - Milk boiler / Hervidor - ø 14 cm (1,7 L)



# STARFLON MAX



gas  
gas



electric  
eléctrica



ceramic glass (electric  
heating element)  
vitrocerámico  
(resistencia eléctrica)

## Paris

- aluminum with interior and exterior Starflon Max nonstick coating | aluminio con revestimiento interno y externo antiaderente Starflon Max
- heat-resistant bakelite handles and nylon knobs | mangos, asas de baquelita antitérmica y agarradores de nylon
- tempered glass lids with stainless steel rim and steam vents | tapas de vidrio templado con borde de acero inoxidable y salida de vapor
- dishwasher safe | resistente a lavavajillas



## Colors | Colores



dark gray | plomo  
warm gray 9c



red | rojo  
7624c



Glass Ceramic  
(electric heating element)  
Vitrocerámico  
(resistencia eléctrica)



NEW | NUEVO

### Frying pan with spatula / Sartén con espátula ø 18, 20, 22, 24, 26, 28, 30 cm

Exterior silicone coating / Revestimiento externo siliconado

Ref.	un.	Kg	m <sup>3</sup>	thick espesor mm	lit.	size tamaño cm	789.1112.	packaging empaque
28508/618		2,42	0,019	1,8	0,6	ø 18	29777.7	
620		2,66	0,021	1,8	0,8	ø 20	29779.1	
622		3,22	0,025	1,8	1,0	ø 22	29781.4	
624	06	3,68	0,031	2,0	1,2	ø 24	29783.8	▲
626		4,27	0,036	2,0	1,8	ø 26	29784.5	
628		5,05	0,041	2,3	2,0	ø 28	29787.6	
630		5,51	0,044	2,3	2,5	ø 30	29789.0	

#### CONTENTS / CONTENIDO

1 - 28507/618 - Frying pan / Sartén  
1 - 25125/000 - Spatula / Espátula

### Frying pan with spatula / Sartén con espátula ø 18, 20, 22, 24, 26, 28, 30 cm



NEW | NUEVO

28500/618		2,42	0,019	1,8	0,6	ø 18	29803.3	
620		2,66	0,021	1,8	0,8	ø 20	29218.5	
622		3,22	0,025	1,8	1,0	ø 22	29805.7	
624	06	3,80	0,030	2,0	1,2	ø 24	29219.2	▲
626		4,27	0,036	2,0	1,8	ø 26	29807.1	
628		5,05	0,041	2,3	2,0	ø 28	29809.5	
630		5,51	0,044	2,3	2,5	ø 30	29220.8	

#### CONTENTS / CONTENIDO

1 - 28501/618 - Frying pan / Sartén  
1 - 25125/000 - Spatula / Espátula

NEW | NUEVO



### Straight frying pan with spatula / Sartén recta con espátula ø 20, 22, 24 cm

28504/620		3,10	0,027	1,8	1,4	ø 20	29755.5	
622	06	3,43	0,031	1,8	1,7	ø 22	29756.2	▲
624		4,12	0,034	1,8	2,0	ø 24	29757.9	

#### CONTENTS / CONTENIDO

1 - 28502/620 - Straight frying pan / Sartén recta  
1 - 25125/000 - Spatula / Espátula

NEW | NUEVO



**Straight frying pan with lid / Sartén recta con tapa - ø 22, 24 cm**

Ref.	un.	Kg	m <sup>3</sup>	thick espesor mm	lit.	size tamaño cm	789.1112	packaging empaque
28505/622	06	6,83	0,058	1,8	1,7	ø 22	29751.7	■
624		8,00	0,069	1,8	2,0	ø 24	29752.4	

NEW | NUEVO



**Deep frying pan / Sartén honda - ø 24, 28 cm**

28509/624	06	3,94	0,030	2,3	2,2	ø 24	29795.1	■
628		5,64	0,044	2,5	3,3	ø 28	29797.5	

NEW | NUEVO



**Pancake mold / Panquequera - ø 28 cm**

28506/628	06	4,20	0,045	1,8	1,8	ø 28	29761.6	■
-----------	----	------	-------	-----	-----	------	---------	---

NEW | NUEVO



**Skillet grill / Bifera - 28 cm**

Exterior silicone coating / Revestimiento externo siliconado

28515/628	06	6,00	0,052	2,5	2,3	28x28	29216.1	■
-----------	----	------	-------	-----	-----	-------	---------	---

NEW | NUEVO



**Skillet with lid / Arrocera con tapa - ø 24 cm**

28517/624	04	6,05	0,059	2,3	2,8	ø 24	29815.6	■
-----------	----	------	-------	-----	-----	------	---------	---

NEW | NUEVO



**Skillet with lid / Sartén honda con tapa - ø 24, 26 cm**

28518/624	04	6,91	0,075	2,3	2,8	ø 24	29820.0	■
626		7,20	0,080	2,3	3,6	ø 26	29821.7	

NEW | NUEVO



**Casserole / Cacerola - ø 18, 20, 22, 24, 26, 28 cm**

Ref.	un.	Kg	m³	thick espesor mm	lit.	size tamaño cm	7891112	packaging empaque
28524/618		4,13	0,032	1,8	2,1	ø 18	29829.3	
620		4,85	0,041	1,8	2,9	ø 20	28137.0	
622	04	5,70	0,047	1,8	3,8	ø 22	28139.4	●
624		6,28	0,058	1,8	4,9	ø 24	29214.7	
626		6,96	0,062	1,8	6,3	ø 26	29830.9	
628		7,90	0,076	1,8	8,0	ø 28	29832.3	

NEW | NUEVO



**Sauce pan / Olla - ø 16, 18, 20, 22 cm**

28525/616		3,23	0,024	1,8	1,5	ø 16	28141.7	
618	04	3,90	0,032	1,8	2,1	ø 18	28143.1	●
620		4,80	0,041	1,8	2,9	ø 20	29835.4	
622		5,55	0,050	1,8	3,8	ø 22	29836.1	

NEW | NUEVO



**Stock pot / Olla alta - ø 16, 18, 20, 22, 24, 26, 28 cm**

28530/616		3,90	0,034	1,8	2,1	ø 16	29839.2	
618		4,60	0,041	1,8	3,1	ø 18	29841.5	
620		5,46	0,060	1,8	4,2	ø 20	29843.9	
622	04	6,21	0,062	1,8	5,7	ø 22	29845.3	●
624		7,00	0,076	1,8	7,1	ø 24	29847.7	
626		7,88	0,090	1,8	9,8	ø 26	29849.1	
628		8,98	0,108	1,8	11,8	ø 28	29851.4	

NEW | NUEVO



**Milk boiler / Hervidor - ø 10, 12, 14, 16 cm**

28531/610		1,84	0,015	1,6	0,8	ø 10	29857.6	
612	06	2,07	0,020	1,6	1,2	ø 12	29859.0	●
614		2,87	0,027	1,6	1,9	ø 14	28145.5	
616		3,45	0,035	1,6	2,7	ø 16	29860.6	

NEW | NUEVO



**Milk boiler with lid / Hervidor con tapa - ø 14, 16 cm**

28532/614	06	4,44	0,037	1,6	1,9	ø 14	29863.7	●
616		5,34	0,051	1,6	2,7	ø 16	29866.8	

NEW | NUEVO



**Pasta cooker / Olla pasta - ø 24 cm**

28535/624	04	7,16	0,088	1,8	7,3	ø 24	29853.8	□
-----------	----	------	-------	-----	-----	------	---------	---

NEW | NUEVO



**Popcorn maker / Olla para hacer palomitas de maíz - ø 22 cm**

Ref.	un.	Kg	m <sup>3</sup>	thick espesor mm	lit.	size tamaño cm	789.1112.	packaging empaques
28536/622	04	7,99	0,103	1,8	4,8	ø 22	29855.2	

NEW | NUEVO



**4 Function set / Juego de 4 funciones**

28538/622	04	9,64	0,082	1,8	5,7	ø 22	29873.6	
-----------	----	------	-------	-----	-----	------	---------	--

**CONTENTS / CONTENIDO**

- 1 - 28530/622 - Stock pot / Olla alta - ø22 cm - 5,7 L
- 1 - 28537/622 - Steamer / Cozi-vapore

NEW | NUEVO



**Wok / Wok - ø 32, 36 cm**

28545/632	04	8,31	0,056	2,0	4,4	ø 32	29867.5	
	636	10,22	0,075	2,0	6,0	ø 36	29868.2	

NEW | NUEVO



**3 pcs. Set in one - Popcorn maker, pasta cooker and stock pot / Juego 3 em 1 - Olla para hacer palomitas de maíz, olla alta - ø 22 cm**

28599/611	04	8,87	0,100	1,8	4,8	ø 22	29871.2	
-----------	----	------	-------	-----	-----	------	---------	--

**CONTENTS / CONTENIDO**

- 1 - Stock pot / Olla alta
- 1 - Glass lid for popcorn maker / Tapa de vidrio para olla para palomitas de maíz
- 1 - Aluminum lid for cooker / Tapa de aluminio para olla pasta



**3 pcs. Roasting pan set / Juego de asaderas 3 pzas.**

Ref.	un.	Kg	m <sup>3</sup>	789.1112.	packaging empaques
28099/600	04	6,01	0,061	28149.3	

**CONTENTS / CONTENIDO**

- 1 - 28000/634 - Deep roasting pan / Asadera rectangular honda - 34 cm (4,9 L)
- 1 - 28003/624 - Round baking pan / Molde para hornear - ø 24 cm (2,1 L)
- 1 - 28004/630 - Pizza pan / Asadera para pizza - ø 30 cm (1,8 L)





### 2 pcs. Frying pan set / Juego de sartenes 2 pzas.

Ref.	un.	Kg	m <sup>3</sup>	789.1112.	packaging empaque
28599/600	04	5,10	0,050	28151.6	

#### CONTENTS / CONTENIDO

- 1 - 28501/622 - Frying pan / Sartén - ø 22 cm (1,0 L)
- 1 - 28501/626 - Frying pan / Sartén - ø 26 cm (1,8 L)



### 5 pcs. Cookware set / Batería de cocina 5 pzas.

28599/601	03	12,65	0,113	28153.0	
-----------	----	-------	-------	---------	--

#### CONTENTS / CONTENIDO

- 1 - 28501/620 - Frying pan / Sartén - ø 20 cm (0,8 L)
- 1 - 28524/620 - Casserole / Cacerola - ø 20 cm (2,9 L)
- 1 - 28525/616 - Sauce pan / Olla - ø 16 cm (1,5 L)
- 1 - 28525/618 - Sauce pan / Olla - ø 18 cm (2,1 L)
- 1 - 28531/614 - Milk boiler / Hervidor - ø 14 cm (1,9 L)



### 7 pcs. Cookware set / Batería de cocina 7 pzas.

28599/602	03	17,96	0,151	28155.4	
-----------	----	-------	-------	---------	--

#### CONTENTS / CONTENIDO

- 1 - 28501/620 - Frying pan / Sartén - ø 20 cm (0,8 L)
- 1 - 28502/622 - Straight frying pan / Sartén recta - ø 22 cm (1,7 L)
- 1 - 28524/620 - Casserole / Cacerola - ø 20 cm (2,9 L)
- 1 - 28524/622 - Casserole / Cacerola - ø 22 cm (3,8 L)
- 1 - 28525/616 - Sauce pan / Olla - ø 16 cm (1,5 L)
- 1 - 28525/618 - Sauce pan / Olla - ø 18 cm (2,1 L)
- 1 - 28531/614 - Milk boiler / Hervidor - ø 14 cm (1,9 L)



NEW | NUEVO



### Frying pan with spatula / Sartén con espátula - ø 20, 24, 28 cm

Exterior silicone coating / Revestimiento externo siliconado

Ref.	un.	Kg	m <sup>3</sup>	thick espesor mm	lit.	size tamaño cm	789.1112.	packaging empaque
28508/720		2,66	0,021	1,8	0,8	ø 20	29780.7	
724	06	3,68	0,031	2,0	1,2	ø 24	29785.2	
728		5,05	0,041	2,3	2,0	ø 28	29788.3	

#### CONTENTS / CONTENIDO

- 1 - 28507/720 - Frying pan / Sartén
- 1 - 25125/000 - Spatula / Espátula

NEW | NUEVO



### Frying pan with spatula / Sartén con espátula - ø 18, 20, 22, 24, 26, 28, 30 cm

28500/718		2,42	0,019	1,8	0,6	ø 18	29804.0	
720		2,66	0,021	1,8	0,8	ø 20	29811.8	
722		3,22	0,025	1,8	1,0	ø 22	29806.4	
724	06	3,68	0,031	2,0	1,2	ø 24	29812.5	
726		4,27	0,036	2,0	1,8	ø 26	29808.8	
728		5,05	0,041	2,3	2,0	ø 28	29810.1	
730		5,51	0,044	2,3	2,5	ø 30	29813.2	

#### CONTENTS / CONTENIDO

- 1 - 28501/718 - Frying pan / Sartén
- 1 - 25125/000 - Spatula / Espátula

NEW | NUEVO



**Straight frying pan with spatula / Sartén recta con espátula - ø 20, 22, 24 cm**

Ref.	un.	Kg	m <sup>2</sup>	thick espesor mm	lit.	size tamaño cm	789.1112.	packaging empaque
28504/720		3,10	0,027	1,8	1,4	ø 20	29758.6	
722	06	3,43	0,031	1,8	1,7	ø 22	29759.3	▲
724		4,12	0,034	1,8	2,0	ø 24	29760.9	

**CONTENTS / CONTENIDO**

- 1 - 28502/720 - Straight frying pan / Sartén recta
- 1 - 25125/000 - Spatula / Espátula

NEW | NUEVO



**Straight frying pan with lid / Sartén recta con tapa - ø 22, 24 cm**

28505/722		6,83	0,058	1,8	1,7	ø 22	29753.1	
724	06	8,00	0,069	1,8	2,0	ø 24	29754.8	■

NEW | NUEVO



**Deep frying pan / Sartén honda - ø 24, 28 cm**

28509/724		3,94	0,030	2,3	2,2	ø 24	29798.2	
728	06	5,64	0,044	2,5	3,3	ø 28	29800.2	■

NEW | NUEVO



**Pancake mold / Panquequera - ø 28 cm**

28506/728	06	4,20	0,045	1,8	1,8	ø 28	29762.3	■
-----------	----	------	-------	-----	-----	------	---------	---

NEW | NUEVO

  
Glass Ceramic  
(electric heating element)  
Vitrocerámico  
(resistencia eléctrica)



**Skillet grill / Bifera - 28 cm**

Exterior silicone coating / Revestimiento externo siliconado

28515/728	06	6,00	0,052	2,5	2,3	ø 28	29826.2	■
-----------	----	------	-------	-----	-----	------	---------	---

NEW | NUEVO



**Skillet with lid / Arrocera con tapa - ø 24 cm**

28517/724	04	6,05	0,059	2,3	2,8	ø 24	29818.7	■
-----------	----	------	-------	-----	-----	------	---------	---

NEW | NUEVO



**Skillet with lid / Sartén con tapa - ø 24, 26 cm**

Ref.	un.	Kg	m <sup>3</sup>	thick espesor mm	lit.	size tamaño cm	789.1112.	packaging empaque
28518/724	04	6,91	0,075	2,3	2,8	ø 24	29822.4	■
726		7,20	0,080	2,3	3,6	ø 26	29823.1	

NEW | NUEVO



**Casserole / Cacerola - ø 18, 20, 22, 24, 26, 28 cm**

28524/718	04	4,13	0,032	1,8	2,1	ø 18	28674.0	●
720		4,85	0,041	1,8	2,9	ø 20	28138.7	
722		5,70	0,047	1,8	3,8	ø 22	28140.0	
724		6,28	0,058	1,8	4,9	ø 24	29834.7	
726		6,96	0,062	1,8	6,3	ø 26	29831.6	
728		7,90	0,076	1,8	8,0	ø 28	29833.0	

NEW | NUEVO



**Sauce pan / Olla - ø 16, 18, 20, 22 cm**

28525/716	04	3,23	0,024	1,8	1,5	ø 16	28142.4	●
718		3,90	0,032	1,8	2,1	ø 18	28144.8	
720		4,80	0,041	1,8	2,9	ø 20	29837.8	
722		5,55	0,050	1,8	3,8	ø 22	29838.5	

NEW | NUEVO



**Stock pot / Olla alta - ø 16, 18, 20, 22, 24, 26, 28 cm**

28530/716	04	3,90	0,034	1,8	2,1	ø 16	29882.8	●
718		4,60	0,041	1,8	3,1	ø 18	29842.2	
720		5,46	0,060	1,8	4,2	ø 20	29844.6	
722		6,21	0,062	1,8	5,7	ø 22	29846.0	
724		7,00	0,076	1,8	7,1	ø 24	29848.4	
726		7,88	0,090	1,8	9,8	ø 26	29850.7	
728		8,98	0,108	1,8	11,8	ø 28	29852.1	

NEW | NUEVO



**Milk boiler / Hervidor - ø 10, 12, 14, 16 cm**

28531/710	06	1,84	0,015	1,6	0,8	ø 10	29858.3	●
712		2,07	0,020	1,6	1,2	ø 12	28675.7	
714		2,87	0,027	1,6	1,9	ø 14	28146.2	
716		3,45	0,035	1,6	2,7	ø 16	29861.3	

NEW | NUEVO



**Milk boiler with lid / Hervidor con tapa - ø 14, 16 cm**

28532/714	06	4,44	0,037	1,6	1,9	ø 14	29864.4	●
716		5,34	0,051	1,6	2,7	ø 16	29865.1	

NEW | NUEVO



**Pasta cooker / Olla pasta - ø 24 cm**

Ref.	un.	Kg	m <sup>3</sup>	thick espesor mm	lit.	size tamaño cm	789.111.2	packaging empaque
28535/724	04	7,16	0,088	1,8	7,3	ø 24	29854.5	

NEW | NUEVO



**Popcorn maker / Olla para palomitas de maíz - ø 22 cm**

28536/722	04	7,99	0,103	1,8	4,8	ø 22	29856.9	
-----------	----	------	-------	-----	-----	------	---------	--

NEW | NUEVO



**4 Function set / Juego de 4 funciones**

28538/722	04	9,64	0,081	1,8	5,7	ø 22	29874.3	
-----------	----	------	-------	-----	-----	------	---------	--

CONTENTS / CONTENIDO

- 1 - 28530/722 - Stock pot / Olla alta - ø 22 cm - 5,7 L
- 1 - 28537/722 - Steamer / Cozi-vapore

NEW | NUEVO



**Wok / Wok - ø 32, 36 cm**

28545/732	04	8,31	0,056	2,0	4,4	ø 32	29869.9	
736		10,22	0,075	2,0	6,0	ø 36	29870.5	

NEW | NUEVO



**3 pcs. Set in one - Popcorn maker, pasta cooker and stock pot / Juego 3 em 1 - Olla para palomitas de maíz, olla pasta, olla alta - ø 22 cm**

28599/711	04	8,87	0,101	1,8	4,8	ø 22	29872.9	
-----------	----	------	-------	-----	-----	------	---------	--

CONTENTS / CONTENIDO

- 1 - Stock pot / Olla alta
- 1 - Glass lid for popcorn maker / Tapa de vidrio para olla para palomitas de maíz
- 1 - Aluminum lid for cooker / Tapa de aluminio para olla pasta



### 3 pcs. Roasting pan set / Juego de asaderas 3 pzas.

Ref.	un.	Kg	m³	789.1112.	packaging empaque
28099/700	04	6,00	0,061	28150.9	

#### CONTENTS / CONTENIDO

- 1 - 28000/734 - Deep roasting pan / Asadera rectangular honda - 34 cm (4,9 L)
- 1 - 28003/724 - Round baking pan / Molde para hornear - ø 24 cm (2,1 L)
- 1 - 28004/730 - Pizza pan / Asadera para pizza - ø 30 cm (1,8 L)



### 2 pcs. Frying pan set / Juego de sartenes 2 pzas.

28599/700	04	5,10	0,050	28152.3	
-----------	----	------	-------	---------	--

#### CONTENTS / CONTENIDO

- 1 - 28501/722 - Frying pan / Sartén - ø 22 cm (1,0 L)
- 1 - 28501/726 - Frying pan / Sartén - ø 26 cm (1,8 L)



### 5 pcs. Cookware set / Batería de cocina 5 pzas.

28599/701	03	12,65	0,113	28154.7	
-----------	----	-------	-------	---------	--

#### CONTENTS / CONTENIDO

- 1 - 28501/720 - Frying pan / Sartén - ø 20 cm (0,8 L)
- 1 - 28524/720 - Casserole / Cacerola - ø 20 cm (2,9 L)
- 1 - 28525/716 - Sauce pan / Olla - ø 16 cm (1,5 L)
- 1 - 28525/718 - Sauce pan / Olla - ø 18 cm (2,1 L)
- 1 - 28531/714 - Milk boiler / Hervidor - ø 14 cm (1,9 L)



### 7 pcs. Cookware set / Batería de cocina 7 pzas.

28599/702	03	18,20	0,151	28156.1	
-----------	----	-------	-------	---------	--

#### CONTENTS / CONTENIDO

- 1 - 28501/720 - Frying pan / Sartén - ø 20 cm (0,8 L)
- 1 - 28502/722 - Straight frying pan / Sartén recta - ø 22 cm (1,7 L)
- 1 - 28524/720 - Casserole / Cacerola - ø 20 cm (2,9 L)
- 1 - 28524/722 - Casserole / Cacerola - ø 22 cm (3,8 L)
- 1 - 28525/716 - Sauce pan / Olla - ø 16 cm (1,5 L)
- 1 - 28525/718 - Sauce pan / Olla - ø 18 cm (2,1 L)
- 1 - 28531/714 - Milk boiler / Hervidor - ø 14 cm (1,9 L)





# STARFLON MAX



gas  
gas



electric  
eléctrica



ceramic glass (electric  
heating element)  
vitrocerámico  
(resistencia eléctrica)

## Vermont

- aluminum with interior and exterior Starflon Max nonstick coating | aluminio con revestimiento interno y externo antiaderente Starflon Max
- heat-resistant bakelite handles and nylon knobs | mangos, asas de baquelita antitérmica y agarradores de nylon
- tempered glass lids with stainless steel rim and steam vents | tapas de vidrio templado con borde de acero inoxidable y salida de vapor
- dishwasher safe | resistente a lavavajillas



### Pancake mold / Panquequera - ø 22 cm

Ref.	un.	Kg	m <sup>3</sup>	thick espesor mm	lit.	size tamaño cm	789.1112.	packaging empaque
27806/011	06	2,18	0,017	1,6	0,6	ø 22	24887.8	



Superior: 0,9 L .....

Bottom pan / Inferior: 0,8 L .....

### Omelette pan / Omeletera - ø 20 cm

27806/012	06	3,26	0,033	1,2	0,8 0,9	ø 20	24888.5	
-----------	----	------	-------	-----	------------	------	---------	--



Glass Ceramic  
(electric heating element)  
Vitrocerámico  
(resistencia eléctrica)



### Skillet grill / Bifera - 28 cm

Exterior silicone coating / Revestimiento externo siliconado

27806/013	06	6,00	0,046	2,5	2,3	28,4x28,4	24889.2	
-----------	----	------	-------	-----	-----	-----------	---------	--



### Frying pan with spatula / Sartén con espátula - ø 20, 24, 28 cm

27806/014		2,78	0,024	1,8	0,8	ø 20	24890.8	
015	06	3,96	0,027	2,0	1,2	ø 24	24891.5	
016		4,92	0,040	2,3	2,0	ø 28	24892.2	

#### CONTENTS / CONTENIDO

- 1 - 27806/914 - Frying pan / Sartén
- 1 - 25125/000 - Spatula / Espátula



### Straight frying pan with spatula / Sartén recta con espátula - ø 24 cm

27806/017	06	4,06	0,035	1,8	2,0	ø 24	24893.9	
-----------	----	------	-------	-----	-----	------	---------	--

#### CONTENTS / CONTENIDO

- 1 - 27806/917 - Straight frying pan / Sartén recta
- 1 - 25125/000 - Spatula / Espátula



**Sauce pan / Olla - ø 16, 18 cm**

Ref.	un.	Kg	m <sup>3</sup>	thick espesor mm	lit.	size tamaño cm	789.1112.	packaging empaque
27806/018	04	2,76	0,023	1,8	1,4	ø 16	24894.6	
019		3,76	0,032	1,8	1,9	ø 18	24895.3	



**Casserole / Cacerola - ø 20, 22, 24 cm**

27806/020	04	4,78	0,041	1,8	2,9	ø 20	24896.0	
021		5,19	0,049	1,8	4,0	ø 22	24897.7	
022		5,90	0,058	1,8	4,9	ø 24	24898.4	



**Milk boiler / Hervidor - ø 14 cm**

27806/023	06	2,63	0,027	1,6	1,9	ø 14	24899.1	
-----------	----	------	-------	-----	-----	------	---------	--



**Pasta cooker / Olla pasta - ø 24 cm**

27806/024	04	6,59	0,080	1,8	7,3	ø 24	24900.4	
-----------	----	------	-------	-----	-----	------	---------	--



**Popcorn maker / Olla para hacer palomitas de maíz - ø 22 cm**

27806/025	04	7,81	0,097	1,8	4,8	ø 22	24901.1	
-----------	----	------	-------	-----	-----	------	---------	--



**Wok / Wok - ø 32 cm**

27806/027	04	8,95	0,058	2,0	4,5	ø 32	24903.5	
-----------	----	------	-------	-----	-----	------	---------	--

CONTENTS / CONTENIDO  
 1 - 27806/927 - Wok / Wok - ø 32 cm (2,0 L)  
 1 - 25126/000 - Serving spoon / Cuchara para servir



**5 pcs. Cookware set / Batería de cocina 5 pzas.**

Ref.	un.	Kg	m <sup>3</sup>	789.1112.	packaging empaque
27899/041	02	7,83	0,061	24908.0	

**CONTENTS / CONTENIDO**

- 1 - 27806/914 - Frying pan / Sartén - ø 20 cm (0,8 L)
- 1 - 27806/023 - Milk boiler / Hervidor - ø 14 cm (1,9 L)
- 1 - 27806/020 - Casserole / Cacerola - ø 20 cm (2,9 L)
- 1 - 27806/018 - Sauce Pan / Olla - ø 16 cm (1,4 L)
- 1 - 27806/019 - Sauce Pan / Olla - ø 18 cm (1,9 L)



**7 pcs. Cookware set / Batería de cocina 7 pzas.**

27899/040	02	11,30	0,081	24907.3	
-----------	----	-------	-------	---------	--

**CONTENTS / CONTENIDO**

- 1 - 27806/029 - Straight frying pan / Sartén recta - ø 22 cm (1,7 L)
- 1 - 27806/914 - Frying pan / Sartén - ø 20 cm - (0,8 L)
- 1 - 27806/020 - Casserole / Cacerola - ø 20 cm (2,9 L)
- 1 - 27806/021 - Casserole / Cacerola - ø 22 cm (4,0 L)
- 1 - 27806/018 - Sauce Pan / Olla - ø 16 cm (1,4 L)
- 1 - 27806/019 - Sauce Pan / Olla - ø 18 cm (1,9 L)
- 1 - 27806/023 - Milk boiler / Hervidor - ø 14 cm (1,9 L)







## Kettles | Teteras

- aluminum with interior and exterior Starflon Max nonstick coating | aluminio con revestimiento interno y externo antiaderente Starflon Max
- heat-resistant bakelite handles and nylon knobs | mangos de baquelita antitérmica y agarradores de nylon
- aluminum or tempered glass lids with stainless steel rim | tapas de aluminio con borde de acero inoxidable
- dishwasher safe | resistente a lavavajillas



gas  
gas



electric  
eléctrica



ceramic glass (electric heating element)  
vitrocerámico (resistencia eléctrica)

### Colors | Colores



dark blue | azul marino  
8505c



off white | cool gray  
4c



cooper | cobre  
7522c



dark gray | plomo  
warm gray 9c



red | rojo  
7624c



graphite | grafito  
cool gray 7c



navy blue | azul marino  
2189c



terracotta orange | naranja terracota  
7587c

NEW | NUEVO



#### Kettle / Tetera 2,3 L

Ref.	un.	Kg	m <sup>3</sup>	thick espesor mm	lit.	789.1112.	packaging empaque
28596/123	04	4,39	0,035	1,8	2,3	30094.1	

NEW | NUEVO



#### Kettle / Tetera 2,3 L

28596/323	04	4,39	0,035	1,8	2,3	30095.8	
-----------	----	------	-------	-----	-----	---------	--

NEW | NUEVO



#### Kettle / Tetera 2,3 L

28596/923	04	4,39	0,035	1,8	2,3	30096.5	
-----------	----	------	-------	-----	-----	---------	--



watch the video



vea el vídeo

**Kettle / Tetera 1,9 L**

Ref.	un.	Kg	m <sup>3</sup>	thick espesor mm	lit.	789.1112.	packaging empaque
28534/619	04	4,21	0,042	1,6	1,9	28147.9	<input type="checkbox"/>



watch the video



vea el vídeo

**Kettle / Tetera 1,9 L**

28534/719	04	4,21	0,042	1,6	1,9	28148.6	<input type="checkbox"/>
-----------	----	------	-------	-----	-----	---------	--------------------------

NEW | NUEVO



watch the video



vea el vídeo

**Kettle / Tetera 2,2 L**

28595/322	04	3,33	0,035	1,4	2,2	30093.4	<input type="checkbox"/>
-----------	----	------	-------	-----	-----	---------	--------------------------

NEW | NUEVO



watch the video



vea el vídeo

**Kettle / Tetera 1,9 L**

28594/119	04	3,10	0,038	1,6	1,9	30090.3	<input type="checkbox"/>
-----------	----	------	-------	-----	-----	---------	--------------------------

NEW | NUEVO



watch the video



vea el vídeo

**Kettle / Tetera 1,9 L**

28594/419	04	3,10	0,038	1,6	1,9	30091.0	<input type="checkbox"/>
-----------	----	------	-------	-----	-----	---------	--------------------------





# STAR FLON EXCEL LENT

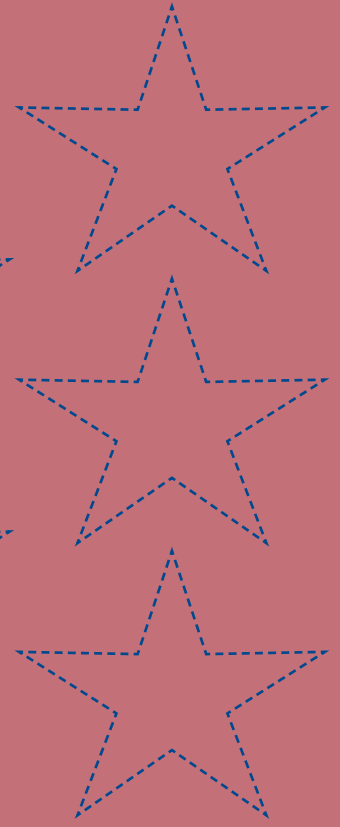

**NO MATTER THE HOUR: THE WEEK'S  
RECIPES ARE GUARANTEED. | NO IMPORTA  
LA HORA: LAS RECETAS DE LA SEMANA  
ESTÁN GARANTIZADAS.**



**228. Sicília** With an interior and exterior Starflon Excellent nonstick coating, you ensure a touch of style when preparing a recipe. It is the ideal choice for those who want beautiful, complete, and convenient sauce pans.

El revestimiento interno y externo con antiadherente Starflon Excellent les da un toque de estilo a las recetas. Es la opción ideal para quienes desean ollas bonitas, completas y prácticas.



Nonstick  
No se pega



Easy to clean  
Fácil de limpiar



Healthier  
Más saludable



More durable  
Más durable



PFOA free  
Libre de PFOA





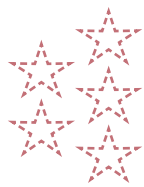

# STARFLON EXCELLENT



## Sicília

- aluminum with interior and exterior Starflon Excellent nonstick coating | alumínio com revestimento interno y externo antiaderente Starflon Excellent
- heat-resistant bakelite handles and knobs | mangos, asas y agarradores de baquelita antitérmica
- tempered glass lids with stainless steel rim and steam vents | tapas de vidrio templado con bordes de acero inoxidable y salida de vapor
- dishwasher safe | resistente a lavavajillas



watch the video



vea el vídeo

### Colors | Colores



light brown | avellana  
warm gray 9c



red | rojo pimienta  
7628c

NEW | NUEVO



#### Frying pan / Sartén - ø 20, 24, 28 cm

Ref.	un.	Kg	m <sup>3</sup>	thick espesor mm	lit.	size tamaño cm	789.1112.	packaging empaque
20400/620	06	3,72	0,032	3,0	0,95	ø 20	27825.7	■
720						27826.4		
624		4,78	0,041	3,0	1,2	ø 24	27828.8	
724						27827.1		
628		5,94	0,053	3,0	2,0	ø 28	27829.5	
728						27830.1		

NEW | NUEVO



#### Skillet with lid / Sartén honda con tapa - ø 24 cm

Ref.	un.	Kg	m <sup>3</sup>	thick espesor mm	lit.	size tamaño cm	789.1112.	packaging empaque
20406/624	04	7,58	0,057	3,0	2,5	ø 24	29984.9	●
724						29985.6		

NEW | NUEVO



#### Casserole / Cacerola - ø 20, 24 cm

Ref.	un.	Kg	m <sup>3</sup>	thick espesor mm	lit.	size tamaño cm	789.1112.	packaging empaque
20402/620	04	6,30	0,040	3,0	2,4	ø 20	27832.5	●
720						27831.8		
624		8,66	0,058	3,0	4,3	ø 24	27833.2	
724						27834.9		

NEW | NUEVO



#### Stock pot / Olla alta - ø 24, 26 cm

Ref.	un.	Kg	m <sup>3</sup>	thick espesor mm	lit.	size tamaño cm	789.1112.	packaging empaque
20407/624	04	9,91	0,073	3,0	5,7	ø 24	30615.8	●
724						30616.5		
626		11,68	0,095	3,0	7,6	ø 26	30318.8	
726						30319.5		



NEW | NUEVO



**Sauce pan / Olla - ø 16, 18, 20 cm**

Ref.	un.	Kg	m <sup>3</sup>	thick espesor mm	lit.	size tamaño cm	789.1112.	packaging empaques
20403/616							27836.3	
■ 716		4,72	0,031	3,0	1,3	ø 16	27835.6	
■ 618	04	5,51	0,039	3,0	1,9	ø 18	27837.0	○
■ 718							27838.7	
■ 620		6,42	0,048	3,0	2,4	ø 20	30316.4	
■ 720	30317.1							

NEW | NUEVO



**Milk boiler / Hervidor - ø 14 cm**

■ 20405/614	04	2,54	0,022	1,8	1,9	ø 14	29962.7	○
■ 714							29963.4	



**5 pcs. Cookware set / Bateria de cocina 5 pzas.**

Ref.	un.	Kg	m <sup>3</sup>	thick espesor mm	789.1112.	packaging empaques
■ 20499/615	02	14,77	0,104	3,0	27905.6	□
■ 715					27906.3	

**CONTENTS / CONTENIDO**

- 1 - 20402/620 - Casserole / Cacerola - ø 20 cm (2,4 L)
- 1 - 20402/624 - Casserole / Cacerola - ø 24 cm (4,3 L)
- 1 - 20403/616 - Sauce Pan / Olla - ø 16 cm (1,3 L)
- 1 - 20403/618 - Sauce Pan / Olla - ø 18 cm (1,9 L)
- 1 - 20404/624 - Deep frying pan / Sartén Honda - ø 24 cm (2,5 L)



**4 pcs. Cookware set / Bateria de cocina 4 pzas.**

■ 20499/616	02	12,30	0,101	3,0	28164.6	□
■ 716					28165.3	

**CONTENTS / CONTENIDO**

- 1 - 20400/624 - Frying pan / Sartén - ø 24 cm (1,2 L)
- 1 - 20402/620 - Casserole / Cacerola - ø 20 cm (2,4 L)
- 1 - 20402/624 - Casserole / Cacerola - ø 24 cm (4,3 L)
- 1 - 20403/618 - Sauce Pan / Olla - ø 18 cm (1,9 L)



**2 pcs. Frying pan set / Juego de sartenes 2 pzas.**

■ 20499/617	04	7,14	0,051	3,0	28166.0	□
■ 717					28167.7	

**CONTENTS / CONTENIDO**

- 1 - 20400/624 - Frying pan / Sartén - ø 24 cm (1,2 L)
- 1 - 20400/628 - Frying pan / Sartén - ø 28 cm (2,0 L)



# STAR FLON PRE MIUM



**DARING IN THE KITCHEN IS DISCOVERING NEW RECIPES. | OSAR EN LA COCINA ES DESCUBRIR NUEVAS RECETAS.**

**232. Mônaco Induction**  
**235. Refinatta**

Nothing better than new finishes, tongs and elegant details to stimulate the discovery of new recipes. The pans that have the Starflon Premium nonstick coating still come in different colors and materials. A full plate for anyone who wants to dare in the kitchen.

Nada mejor que nuevos acabados, agarradores y detalles elegantes para estimular el descubrimiento de nuevas recetas. Las ollas con revestimiento antiadherente Starflon Premium también están disponibles en diferentes colores y materiales. Un plato lleno para quienes quieren atreverse en la cocina.



Nonstick  
No se pega



Easy to clean  
Fácil de limpiar



Healthier  
Más saludable



More durable  
Más durable



PFOA free  
Libre de PFOA





# STARFLON PREMIUM

## Mônaco Induction



gas  
gas



electric  
eléctrica



ceramic glass (electric  
heating element)  
vitrocerámico  
(resistencia eléctrica)



induction  
inducción

- reinforced aluminum with interior Starflon Premium nonstick coating | aluminio reforzado con revestimiento interno de antiadherente Starflon Premium
- exterior silicone or Starflon Premium nonstick coating | revestimiento externo siliconado o antiadherente Starflon Premium

- metal handles and knobs with silicone protection | mangos, asas y agarradores metálicos con protección de silicone
- tempered glass lids with steam vent and stainless steel rim | tapas de vidrio templado con bordes de acero inoxidable y salida de vapor

- dishwasher safe / resistente a lavavajillas



watch the video



vea el vídeo

### Colors | Colores



black | negro  
black c



red | rojo  
1807c

### Frying pan / Sartén - ø 20, 24, 26, 28 cm



induction  
inducción



Ref.	un.	Kg	m <sup>3</sup>	thick espesor mm	lit.	size tamaño cm	789.1112.	packaging empaque	
■ 28700/020	06	4,16	0,021	3,0	1,0	ø 20	27970.4	—	
■ 720									27971.1
■ 024		5,66	0,031	3,0	1,6	ø 24			27972.8
■ 724									27973.5
■ 026		6,44	0,041	3,0	2,0	ø 26			27974.2
■ 726									27975.9
■ 028		7,02	0,034	3,0	2,4	ø 28			27976.6
■ 728	27977.3								



induction  
inducción



### Pancake mold / Panquequera - ø 22 cm

■ 28701/022	06	4,62	0,032	3,0	0,8	ø 22	27980.3	—
■ 722							27981.0	



induction  
inducción



### Skillet grill / Bifera - 24 cm

■ 28702/024	06	5,88	0,044	3,0	1,5	24,8x24,8	27982.7	—
■ 724							27983.4	



**Deep frying pan / Sartén honda - ø 24 cm**

Ref.	un.	Kg	m <sup>3</sup>	thick espesor mm	lit.	size tamaño cm	789.1112.	packaging empaque
■ 28703/024	04	4,46	0,031	3,0	2,7	ø 24	27984.1	■
■ 724							27985.8	



**Deep frying pan with lid / Sartén honda con tapa - ø 24 cm**

■ 28704/024	04	8,30	0,072	3,0	2,7	ø 24	27986.5	●
■ 724							27987.2	



**Casserole / Cacerola - ø 20, 22, 24, 28 cm**

■ 28705/020	04	6,42	0,040	3,0	2,6	ø 20	27988.9	●
■ 720							27989.6	
■ 022	04	7,82	0,048	3,0	3,5	ø 22	27990.2	●
■ 722							27991.9	
■ 024	04	8,44	0,063	3,0	4,5	ø 24	27992.6	●
■ 724							27993.3	
■ 028	04	11,20	0,069	3,0	6,4	ø 28	27994.0	●
■ 728							27995.7	



**Sauce Pan / Olla - ø 18, 20 cm**

■ 28706/018	04	5,96	0,046	3,0	2,0	ø 18	27996.4	●
■ 718							27997.1	
■ 020	04	7,12	0,060	3,0	2,6	ø 20	27998.8	●
■ 720							27999.5	



**Skillet with lid / Arrocera con tapa - ø 28 cm**

■ 28707/028	04	9,62	0,053	3,0	4,2	ø 28	28000.7	●
■ 728							28001.4	





induction  
inducción



**Wok / Wok - ø 32 cm**

Ref.	un.	Kg	m³	thick espesor mm	lit.	size tamaño cm	789.1112.	packaging empaque
■ 28708/032	04	10,32	0,063	3,0	4,5	ø 32	28002.1	☐
■ 732							28003.8	



induction  
inducción



**Pasta cooker / Olla pasta - ø 22 cm**

■ 28709/022	04	10,06	0,064	3,0	5,4	ø 22	28004.5	☐
■ 722							28005.2	

**Lid / Tapa ø 16, 18, 20, 22, 24, 28, 32, 36 cm**

Ref.	un.	Kg	m³	medida cm	789.1112.	apresentação
20849/016	01	0,54	0,004	ø 16	12704.3	☐
018		0,60	0,004	ø 18	12705.0	
020		0,66	0,004	ø 20	12706.7	
022		0,80	0,006	ø 22	12707.4	
024		0,88	0,006	ø 24	12708.1	
028		1,20	0,010	ø 28	12709.8	
032		1,52	0,013	ø 32	12710.4	
036		1,74	0,013	ø 36	12711.1	



induction  
inducción



**4 pcs. Cookware set / Bateria de cocina 4 pzas**

Ref.	un.	Kg	m³	789.1112.	packaging empaque
■ 28799/001	02	13,98	0,116	28108.0	☐
■ 701				28009.0	

**CONTENTS / CONTENIDO**

- 1 - 28703/024 - Deep frying pan / Sartén honda - ø 24 cm (2,7 L)
- 1 - 28705/020 - Casserole / Cacerola - ø 20 cm (2,6 L)
- 1 - 28705/024 - Casserole / Cacerola - ø 24 cm (4,5 L)
- 1 - 28706/018 - Sauce pan / Olla - ø 18 cm (2,0 L)



induction  
inducción



**5 pcs. Cookware set / Bateria de cocina 5 pzas**

■ 28799/002	02	17,46	0,125	28109.7	☐
■ 702				28110.3	

**CONTENTS / CONTENIDO**

- 1 - 28703/024 - Deep frying pan / Sartén honda - ø 24 cm (2,7 L)
- 1 - 28705/022 - Casserole / Cacerola - ø 22 cm (3,5 L)
- 1 - 28705/024 - Casserole / Cacerola - ø 24 cm (4,5 L)
- 1 - 28706/018 - Sauce pan / Olla - ø 18 cm (2,0 L)
- 1 - 28706/020 - Sauce pan / Olla - ø 20 cm (2,6 L)



# STAR FLON PREMIUM

## Refinatta



gas  
gas



electric  
eléctrica



ceramic glass (electric  
heating element)  
vitrocerámico  
(resistencia eléctrica)



induction  
inducción

- reinforced aluminum with interior Starflon Premium nonstick coating | aluminio reforzado con revestimiento interno de antiadherente Starflon Premium
- exterior silicone or Starflon Premium nonstick coating | revestimiento externo siliconado o antiadherente Starflon Premium
- stainless steel handles with silicone covering and silicone knob | mangos, asas de acero inoxidable con protección de silicone y agarradores de silicone
- tempered glass lid with steam vent and silicone rim | tapas de vidrio templado con bordes de silicone y salida de vapor
- dishwasher safe | resistente a lavavajillas



### Colors | Colores



golden | dorado  
8495c



red | rojo  
207c



induction  
inducción



#### Deep frying pan / Sartén honda - 24 cm

Ref.	un.	Kg	m <sup>3</sup>	thick espesor mm	lit.	size tamaño cm	789.1112.	packaging empaque
■ 20912/324	01	2,30	0,016	3,0	2,8	24	24760.4	☐
■ 724							24761.1	



induction  
inducción



#### Casserole / Cacerola - 24, 26 cm

■ 20913/324	01	2,42	0,014	3,0	4,8	24	24762.8	☐
■ 724							24763.5	
■ 326		2,76	0,017	3,0	5,7	26	24764.2	
■ 726							24765.9	



induction  
inducción



#### Sauce pan / Olla - 18 cm

■ 20914/318	01	1,64	0,012	3,0	2,2	18	24766.6	☐
■ 718							24767.3	

# STAR FLON HIGH PERFORMANCE

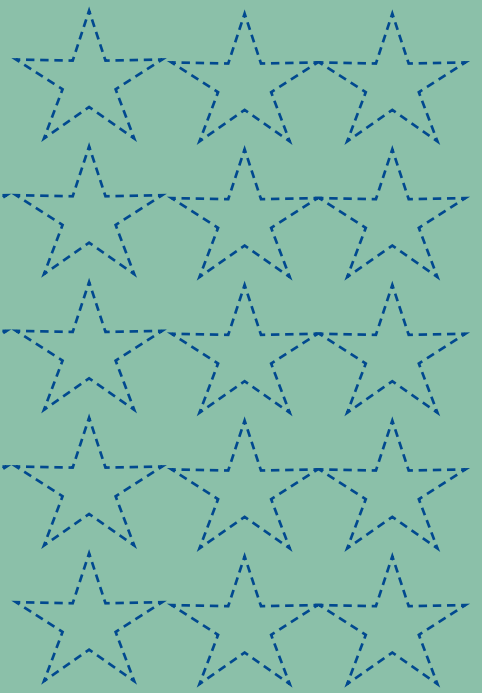

**IF INSPIRATION COMES FROM WHERE WE LEAST EXPECT, HIGH PERFORMANCE IS THE EXCEPTION TO THE RULE. | SI LA INSPIRACIÓN VIENE DE DONDE MENOS ESPERAMOS, HIGH PERFORMANCE ES LA EXCEPCIÓN A LA REGLA.**

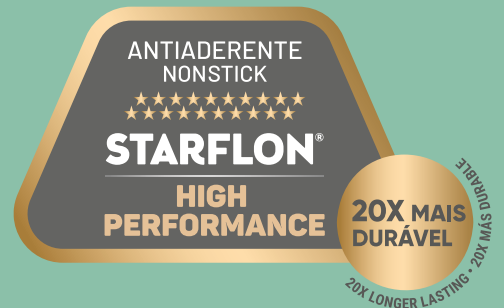

**238. Lyon**

As soon as we look at a pan that has a Starflon High Performance nonstick coating, we imagine a world of recipes and flavors. Impeccable finishes, elegant colors and sophisticated design prepare unforgettable moments around the table, which arise through the inspiration that only a product of this level can provide.

En cuanto vemos una olla con el revestimiento antiadherente Starflon High Performance, nos imaginamos un mundo de recetas y sabores. Las impecables terminaciones, los elegantes colores y el sofisticado diseño preparan momentos inolvidables alrededor de la mesa, que surgen gracias a la inspiración que sólo un producto de este nivel puede proporcionar.



Nonstick  
No se pega



Easy to clean  
Fácil de limpiar



Healthier  
Más saludable



More durable  
Más durable



PFOA free  
Libre de PFOA



TRAMONTINA



# STARFLON HIGH PERFORMANCE



gas  
gas



eléctrica  
eléctrica



ceramic glass (electric heating element)  
vitrocerámico (resistencia eléctrica)



inducción  
inducción

## Lyon

- reinforced aluminum with interior Starflon High Performance nonstick coating | aluminio reforzado con revestimiento interno de antiadherente Starflon High Performance
- exterior silicone or Starflon High Performance nonstick coating | revestimiento externo siliconado o antiadherente Starflon High Performance
- aluminum lids | tapas de aluminio



watch the video



vea el vídeo

## Colors | Colores



red | rojo  
199c



black | negro  
black 2c



golden | dorado  
8945c

### Casserole / Cacerola - ø 24, 26, 30 cm

Exterior silicone coating / Revestimiento externo siliconado

Ref.	un.	Kg	m <sup>3</sup>	thick espesor mm	lit.	size tamaño cm	789.1112.	packaging empaque
■ 20940/724		4,02	0,028	8,0	3,7	ø 24	13185.9	
■ 726	01	4,92	0,028	8,0	4,6	ø 26	10153.1	☐
■ 730		5,52	0,028	8,0	6,8	ø 30	10155.5	

Interior and exterior Starflon High Performance nonstick coating / Revestimiento interno y externo de antiadherente Starflon High Performance

■ 20960/024		4,02	0,028	8,0	3,7	ø 24	11576.7	
■ 026		4,92	0,028	8,0	4,6	ø 26	11577.4	
■ 030		5,52	0,028	8,0	6,8	ø 30	11578.1	
■ 424	01	4,02	0,028	8,0	3,7	ø 24	09255.6	☐
■ 426		4,92	0,028	8,0	4,6	ø 26	09258.7	
■ 430		5,52	0,028	8,0	6,8	ø 30	09175.7	

### Sauce pan / Olla - ø 20 cm

Exterior silicone coating / Revestimiento externo siliconado

■ 20941/720	01	2,94	0,022	6,0	2,8	ø 20	10157.9	☐
-------------	----	------	-------	-----	-----	------	---------	---

Interior and exterior Starflon High Performance nonstick coating / Revestimiento interno y externo de antiadherente Starflon High Performance

■ 20961/020	01	2,94	0,022	6,0	2,8	ø 20	11570.5	☐
■ 420							09249.5	



inducción  
inducción



inducción  
inducción



### Frying pan / Sartén - ø 32 cm

Exterior silicone coating / Revestimiento externo siliconado

Ref.	un.	Kg	m <sup>3</sup>	thick espesor mm	lit.	size tamaño cm	789.1112.	packaging empaque
■ 20931/732	01	5,24	0,020	8,0	4,3	ø 32	10151.7	

Interior and exterior Starflon High Performance nonstick coating /  
Revestimiento interno y externo de antiadherente Starflon High  
Performance

■ 20951/032	01	5,24	0,020	8,0	4,3	ø 32	11573.6	
■ 432							09168.9	



### Square casserole / Cacerola cuadrada - 28 cm

Exterior silicone coating / Revestimiento externo siliconado

■ 20943/728	01	5,54	0,028	8,0	5,5	28x28	10159.3	
-------------	----	------	-------	-----	-----	-------	---------	--

Interior and exterior Starflon High Performance nonstick coating /  
Revestimiento interno y externo de antiadherente Starflon High  
Performance

■ 20963/028	01	5,54	0,028	8,0	5,5	28x28	11571.2	
■ 428							09178.8	



### Lyon 360

Exterior silicone coating / Revestimiento externo siliconado

Ref.	un.	Kg	m <sup>3</sup>	789.1112.	packaging empaque
■ 20999/753	01	8,40	0,045	18607.1	

Interior and exterior Starflon High Performance nonstick coating /  
Revestimiento interno y externo de antiadherente Starflon High  
Performance

■ 20999/053	01	8,40	0,045	25056.7	
■ 453				25057.4	

#### CONTENTS / CONTENIDO

- 1 - 20964/728 - Dutch oven with grill lid / Olla con tapa grill 28 cm (5,5 L)
- 1 - 20062/024 - Cake and pudding pan / Budinera - ø 24 cm (2,6 L)
- 2 - 20069/022 - Bread mold / Molde para pan y tortera - 22 cm (1,2 L)
- 1 - 29900/470 - Stainless steel cooking grate / Parrilla de acero inoxidable



# CERAMIC

# CERÁMICO

## ANOTHER SPECIAL TOUCH TO THE RECIPES. | OTRO TOQUE ESPECIAL A LAS RECETAS.

**242. Ítria**

**243. Évora**

Adding more beauty, durability and efficiency to the kitchen makes recipes even tastier. Practical and highly resistant, Tramontina's ceramic-coated pans add a touch of elegance and sophistication when needed, as well as being safe to handle and making everyday meals even easier to prepare.

Al añadir más belleza, durabilidad y eficiencia en la cocina, las recetas son aún más sabrosas. Prácticas y muy resistentes, las ollas con revestimiento cerámico de Tramontina dan un toque de elegancia y sofisticación cuando es necesario, además de ser seguras en su uso y facilitar aún más la preparación de las comidas del día a día.

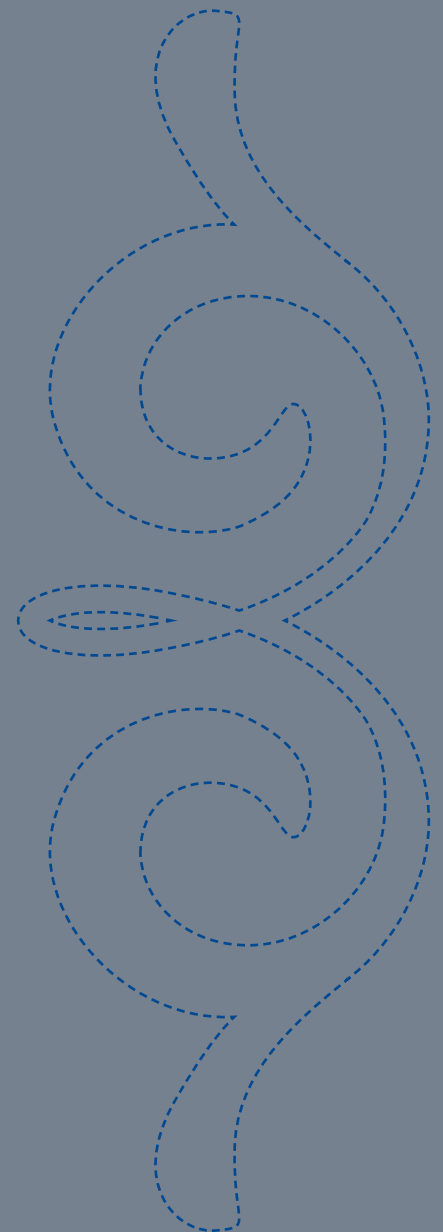



# CERAMIC CERÁMICO



## Ítria

- aluminum with interior and exterior ceramic coating | aluminio con revestimiento interno e externo cerámico
- tempered glass lids with silicone rim | tapas de vidrio templado con borde de silicone
- polypropylene lids | tapas de polipropileno
- heat-resistant handle | mango compuesto de material antitérmico
- convenience and safety when handling | practicidad y seguridad en el manejo



watch the video



vea el vídeo



10 pcs. Multipurpose cookware set / Batería de cocina multiuso 10 pzas.

Ref.	un.	Kg	m <sup>3</sup>	thick espesor mm	789.1112.	packaging empaque
■ 20999/100	01	4,86	0,027	3,0	29979.5	
■ 700					30867.1	

NEW | NUEVO

### CONTENTS / CONTENIDO

- 1 - 20917/000 - Removable handle / Mango removable
- 1 - 20919/120 - Sauce pan / Olla - ø 20 cm (2,8 L)
- 1 - 20919/122 - Sauce pan / Olla - ø 22 cm (3,1 L)
- 1 - 20918/124 - Deep frying pan / Sartén honda - ø 24 cm (2,6 L)
- 1 - 20919/080 - Glass lid / Tapa de vidrio - ø 20 cm
- 1 - 20919/082 - Glass lid / Tapa de vidrio - ø 22 cm
- 1 - 20918/084 - Glass lid / Tapa de vidrio - ø 24 cm
- 1 - 20919/380 - Plastic lid / Tapa plástica - ø 20 cm
- 1 - 20919/382 - Plastic lid / Tapa plástica - ø 22 cm
- 1 - 20918/384 - Plastic lid / Tapa plástica - ø 24 cm



CE  
RAM  
IC

CERÁ  
MICO

## Évora

- aluminum with interior and exterior ceramic coating | aluminio con revestimiento interno e externo cerámico
- exterior silicone coating | revestimiento externo siliconado
- heat resistant bakelite handles and nylon knobs | mangos, asas de baquelita antitérmica y agarradores de nylon
- tempered glass lids with steam vent and stainless steel rim | tapas de vidrio templado con salida de vapor y bordes de acero inoxidable
- dishwasher safe | resistente a lavavajillas



gas  
gas



electric  
eléctrica



ceramic glass (electric  
heating element)  
vitrocerámico  
(resistencia eléctrica)



watch the video



vea el vídeo

### Colors | Colores



living coral | coral  
2031c



mosaic blue | azul mosaico  
3155c



#### 5 pcs. Cookware set / Batería de cocina 5 pzas.

Ref.	un.	Kg	m <sup>3</sup>	thick espesor mm	789.1112.	packaging empaque
■ 28699/201	02	10,50	0,090	2,5	28372.5	■
■ 401					28373.2	

#### CONTENTS / CONTENIDO

- 1 - 28601/422 - Straight frying pan / Sartén recta - ø 22 cm (1,6 L)
- 1 - 28602/422 - Casserole / Cacerola - ø 22 cm (3,6 L)
- 1 - 28603/416 - Sauce pan / Olla - ø 16 cm (1,3 L)
- 1 - 28603/418 - Sauce pan / Olla - ø 18 cm (2,0 L)
- 1 - 28604/414 - Milk boiler / Hervidor - ø 14 cm (1,8 L)



# PROFESSIONAL FRYING PANS

# SAR TENES PROFESIONALES

**COOK LIKE A PRO. |  
COCINE COMO UN PROFESIONAL.**

Professional is in its name, but it also blends in very well with kitchens in every home. If the rule is to have fun preparing recipes, discover new flavors and have a product that does not release residues on food, Tramontina's Professional Frying Pan line is the right choice for bars, homes and restaurants.

Tiene un nombre profesional, pero también se adapta muy bien a las cocinas de todos los hogares. Si la regla es divertirse preparando recetas, descubrir nuevos sabores y contar con un producto que no deje residuos en los alimentos, la línea de Sartenes Profesionales de Tramontina es la opción correcta para bares, hogares y restaurantes.

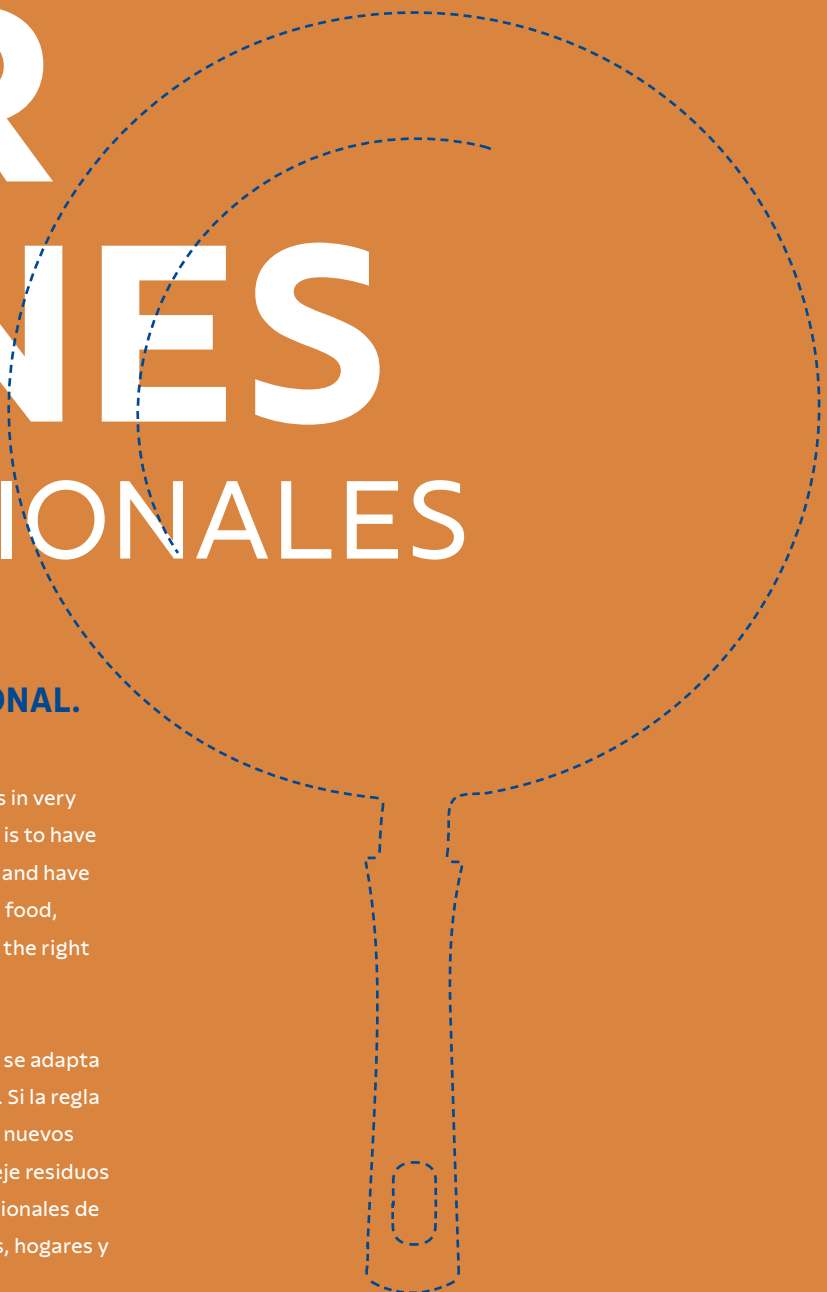





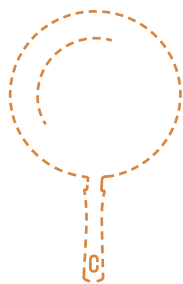

# PROFESSIONAL FRYING PANS

# SAR TENES PROFESIONALES



gas  
gas



electric  
eléctrica



ceramic glass (electric  
heating element)  
vitrocerámico  
(resistencia eléctrica)

- reinforced aluminum with interior Starflon Premium nonstick coating | aluminio reforzado con revestimiento interno de antiaderente Starflon Premium
- polished exterior finish | terminación externa lijada
- silicone or heat resistant bakelite handles and metal handles | mangos de baquelita antitérmica o silicone y asas metálicas
- effective method of securing handles with rivets | eficiente sistema de fijación con remaches



### Frying pan / Sartén - ø 20, 25, 30 cm

Ref.	un.	Kg	m <sup>3</sup>	thick espesor mm	lit.	size tamaño cm	789.1112.	packaging empaque
20890/020		4,85	0,026	3,6	1,0	ø 20	07751.5	
025	06	7,40	0,035	3,6	2,0	ø 25	07752.2	■
030		10,68	0,047	3,6	3,0	ø 30	07753.9	



### Frying pan / Sartén - ø 35 cm

20891/036	06	15,40	0,108	3,6	5,6	ø 35	08933.4	■
-----------	----	-------	-------	-----	-----	------	---------	---



### Frying pan / Sartén - ø 24, 28, 30, 32 cm

20892/024		9,77	0,055	3,0	1,3	ø 24	08935.8	
028	12	11,80	0,063	3,0	2,0	ø 28	08936.5	■
030		13,60	0,072	3,0	2,3	ø 30	08937.2	
032		15,17	0,073	3,0	3,1	ø 32	08938.9	



### Pancake mold / Panquequera - ø 22 cm

20894/022	12	4,48	0,035	2,0	0,6	ø 22	08946.4	■
-----------	----	------	-------	-----	-----	------	---------	---





**Frying pan / Sartén - ø 28, 32 cm**

Ref.	un.	Kg	m <sup>3</sup>	thick espesor mm	lit.	size tamaño cm	789.1112.	packaging empaque
20895/028	04	3,80	0,029	2,0	3,2	ø 28	08947.1	■
032		4,72	0,054	2,0	4,9	ø 32	08948.8	



**Frying pan / Sartén - ø 38 cm**

20895/038	04	6,62	0,076	2,0	7,1	ø 38	08949.5	■
-----------	----	------	-------	-----	-----	------	---------	---



**Paella pan / Paellera - ø 45, 60 cm**

20896/045	02	4,80	0,042	3,0	9,2	ø 45	08950.1	■
060		7,80	0,076	3,0	18,2	ø 60	08951.8	



**Frying pan / Sartén - ø 20, 24, 26, 28 cm**

20888/020	04	3,00	0,018	3,0	1,0	ø 20	20386.0	■
024		4,00	0,027		1,6	ø 24	20387.7	
026		4,30	0,035		2,0	ø 26	20388.4	
028		4,80	0,037		2,4	ø 28	20389.1	



**Skillet / Sartén para saltar - ø 28 cm**

20883/028	04	5,38	0,044	3,0	3,3	ø 28	22785.9	■
-----------	----	------	-------	-----	-----	------	---------	---

## Frying pans with interior ceramic coating Sartenes con revestimiento interno cerámico



Frying pan / Sartén - ø 24, 28, 30, 32 cm

Ref.	un.	Kg	m <sup>3</sup>	thick espesor mm	lit.	size tamaño cm	789.1112.	packaging empaque
20884/024		3,38	0,024		1,30	ø 24	20376.1	
028	04	4,20	0,032	3,0	2,00	ø 28	20377.8	■
030		4,68	0,032		2,30	ø 30	20378.5	
032		5,20	0,045		3,10	ø 32	20379.2	



Frying pan / Sartén - ø 24, 28, 32 cm

20885/024		5,94	0,036		2,0	ø 24	18576.0	
028	06	7,40	0,053	3,0	3,1	ø 28	18577.7	■
032		9,20	0,074		4,3	ø 32	18578.4	

## Iron frying pans Sartenes de hierro



NEW | NUEVO



Iron frying pan / Sartén de hierro - ø 22, 24, 26, 30 cm

20766/022		5,46	0,033	2,0	1,0	ø 22	30114.6	
024	04	6,34	0,039	2,0	1,3	ø 24	30115.3	□
026		7,74	0,046	2,25	1,7	ø 26	30116.0	
030		10,06	0,061	2,25	2,5	ø 30	30117.7	



NEW | NUEVO



Iron skillet grill / Plancha de hierro - ø 30 cm

20767/030	04	9,96	0,061	2,25	2,4	ø 30	30255.6	□
-----------	----	------	-------	------	-----	------	---------	---

NEW | NUEVO



Paella pan / Paellera - ø 38 cm

20765/038	02	6,82	0,033	2,25	5,1	ø 38	30433.8	□
-----------	----	------	-------	------	-----	------	---------	---







# PRES SURE COOKER

## OLLA DE PRE SIÓN

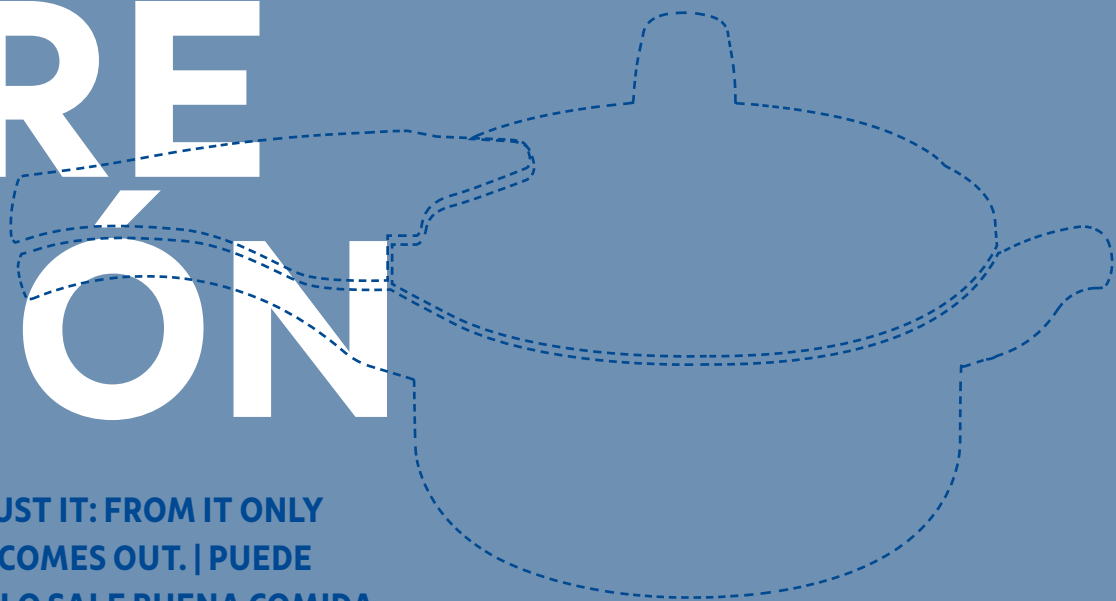

**YOU CAN TRUST IT: FROM IT ONLY  
GOOD FOOD COMES OUT. | PUEDE  
CONFIAR: SOLO SALE BUENA COMIDA  
DE AQUÍ.**

**252. Vancouver**

**253. Vancouver Spot**

**254. Torino**

**255. Valência Black**

**256. Valência**

When the schedule is full, the time requires agility or the recipe calls for even more softness and a homemade touch, putting a little pressure on the ingredients can make the routine easier – a lot easier. In addition to having models in different colors and sizes, which match all kitchens, Tramontina Pressure Cookers have certified safety systems to ensure greater comfort and tranquility during all preparations.

Cuando la agenda está repleta, el tiempo requiere agilidad o la receta pide aún más suavidad y un toque casero, presionar un poco más los ingredientes puede facilitar, y mucho, la rutina. Además de tener modelos en diferentes colores y tamaños que se adaptan a todas las cocinas, las Ollas a Presión Tramontina cuentan con sistemas de seguridad certificados para garantizar mayor comodidad y tranquilidad durante todas las preparaciones.



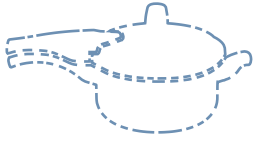

# PRESURE COOKER

## OLLA DE PRESIÓN



gas  
gas



electric  
eléctrica



ceramic glass (electric heating element)  
vitrocerámico (resistencia eléctrica)

## Vancouver

- aluminum pressure cookers | ollas de presión de aluminio
- lid: polished exterior and satin interior | tapa: exterior pulido e interior satinado
- body with interior and exterior Starflon Max nonstick coating | cuerpo con revestimiento externo y interno de antiadherente Starflon Max
- lids with external lock | tapas con cierre externo
- three safety valves | tres válvulas de seguridad
- operating pressure up to 12 psi | trabaja bajo presión de 80 kPa
- efficient and safe | eficiente y segura



### Colors | Colores



blue | azul oceano  
7692c



black | negro  
black c



graphite | grafito  
8625c



red | rojo  
7628c



#### Pressure cooker / Olla de presión - ø 20 cm

Ref.	un.	Kg	m³	thick espesor mm	lit.	size tamaño cm	789.1112.	packaging empaque
■ 20586/620							19959.0	☐
■ 720	04	8,14	0,074	3,2	3,0	ø 20	19960.6	



#### Pressure cooker / Olla de presión - ø 20 cm

■ 20582/120							26465.6	☐
■ 420							26464.9	
■ 620	04	8,08	0,079	3,2	4,5	ø 20	19063.4	
■ 720							19064.1	



#### Pressure cooker / Olla de presión - ø 24 cm

■ 20589/624							20512.3	☐
■ 724	02	5,80	0,057	3,2	6,0	ø 24	20513.0	



#### Silicone ring / Anillo de silicone - ø 20, 24 cm

■ 20579/001							11952.9	▲
■ 016	12	1,13	0,014	-	-	ø 20	21202.2	

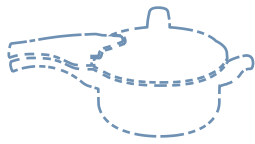

# PRES SURE COOKER

## OLLA DE PRE SIÓN



gas  
gas



electric  
eléctrica



ceramic glass (electric  
heating element)  
vitrocerámico  
(resistencia eléctrica)

## Vancouver Spot

- aluminum pressure cookers | ollas de presión de aluminio
- lid: anodized aluminum | tapa: aluminio anodizado
- body with interior and exterior Starflon Max nonstick coating | cuerpo con revestimiento externo y interno de antiadherente Starflon Max
- lids with external lock | tapas con cierre externo
- three safety valves | tres válvulas de seguridad
- operating pressure up to 12 psi | trabaja bajo presión de 80 kPa
- efficient and safe | eficiente y segura



watch the video



vea el vídeo

## Colors | Colores



dark blue | azul marino  
2189c



dark gray | plomo  
431c



### Pressure cooker / Olla de presión - ø 20 cm

Ref.	un.	Kg	m <sup>3</sup>	thick espesor mm	lit.	size tamaño cm	789.1112.	packaging empaqué
■ 20590/120	04	9,08	0,088	3,2	4,5	ø 20	28434.0	□
■ 620							28435.7	

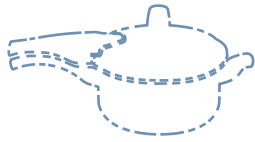

# PRESURE COOKER

## OLLA DE PRESIÓN



## Torino

- aluminum pressure cookers | ollas de presión de aluminio
- lid: polished exterior and satin interior | tapa: exterior pulido e interior satinado
- body with interior and exterior ceramic coating | cuerpo com revestimiento externo y interno cerámico
- lids with external lock | tapas con cierre externo
- operating pressure up to 12 psi | trabaja bajo presión de 80 kPa
- efficient and safe | eficiente y segura



watch the video



vea el vídeo

### Colors | Colores



teal green | verde petróleo  
445c



raspberry red | rojo frambuesa  
7428c



NEW | NUEVO



#### Pressure cooker / Olla de presión - ø 20 cm

Ref.	un.	Kg	m <sup>3</sup>	thick espesor mm	lit.	size tamaño cm	789.1112.	packaging empaque
20558/620	04	10,18	0,069	4,0	4,5	ø 20	27944.9	◻
920							29745.6	◻

NEW | NUEVO



#### Silicone ring / Anillo de silicone - ø 20 cm

20577/011	12	0,98	0,009	-	-	ø 20	28874.4	▲
-----------	----	------	-------	---	---	------	---------	---

NEW | NUEVO



#### Metal protection filter / Filtro metálico de protección

20576/006	20	0,39	0,003	-	-	-	30180.1	●
-----------	----	------	-------	---	---	---	---------	---



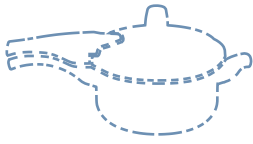

# PRES SURE COOKER

OLLA DE  
PRE  
SIÓN



gas  
gas



electric  
eléctrica



ceramic glass (electric  
heating element)  
vitrocerámico  
(resistencia eléctrica)

## Valência Black

- aluminum pressure cooker | olla de presión de aluminio
- lid: anodized aluminum | tapa: aluminio anodizado
- body with interior and exterior ceramic coating | cuerpo con revestimiento externo y interno cerámico
- lids with external lock | tapas con cierre externo
- operating pressure up to 12 psi | trabaja bajo presión de 80 kPa
- efficient and safe | eficiente y segura



watch the video



vea el vídeo

NEW | NUEVO



### Pressure cooker / Olla de presión - ø 24 cm

Ref.	un.	Kg	m <sup>3</sup>	thick espesor mm	lit.	size tamaño cm	789.1112.	packaging empaque
20565/424	02	6,38	0,051	3,8	7,0	ø 24	28436.4	

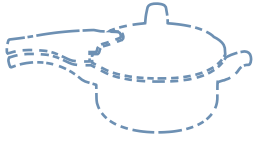

# PRES SURE COOKER

## OLLA DE PRE SIÓN



## Valência

- reinforced aluminum pressure cooker | ollas de presión de aluminio reforzado
- satin interior finish | terminación interna satinada
- polished exterior finish | terminación externa pulida
- lids with external lock | tapas con cierre externo
- 100% safe - four safety valves and pressure indicator system | 100% seguras - cuatro válvulas de seguridad y un sistema indicador de presión
- operating pressure up to 13 psi | trabaja bajo presión de 90kPa



### Pressure cooker / Olla de presión – ø 24 cm

Ref.	un.	Kg	m <sup>3</sup>	thick espesor mm	lit.	size tamaño cm	789.1112.	packaging empaque
20563/024	02	7,08	0,055	3,8	8,0	ø 24	10182.1	



### Pressure cooker / Olla de presión – ø 24 cm

20564/024	02	7,20	0,066	3,8	10,0	ø 24	10183.8	
-----------	----	------	-------	-----	------	------	---------	--



### Silicone ring / Anillo de silicone – ø 24 cm

Ref.	un.	Kg	m <sup>3</sup>	size tamaño cm	789.1112.	packaging empaque
20579/016*	12	1,10	0,009	ø 24	21202.2	



### 3 pcs. Inner rubber seal / Goma de cierre interna 3 pzas.

20579/004*	30	0,44	0,005	-	11955.0	
------------	----	------	-------	---	---------	--



### Metallic protection filter / Filtro metálico de protección

20579/013*	20	0,38	0,003	-	13148.4	
------------	----	------	-------	---	---------	--



# IRON SAUCE PANS

# OLLAS DE HIE RRO

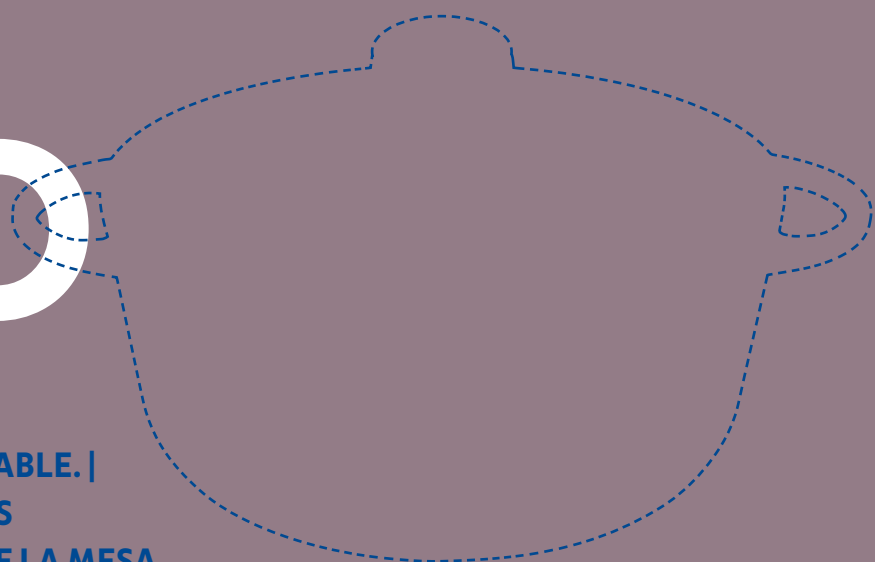

**THE SOURCE OF THE BEST  
MEMORIES AROUND THE TABLE. |  
EL ORIGEN DE LOS MEJORES  
RECUERDOS ALREDEDOR DE LA MESA.**

**260. Trento**

Tramontina Iron Sauce Pans are in the kitchen of everyone who wants to remember a childhood recipe and give each dish that special touch of home cooking. Whether ratatouille or pork ribs, the models made in iron provide more flavor and versatility and also feature an interior Starflon nonstick coating, adapting to both simple and more sophisticated moments around the table.

Las Ollas de Hierro Tramontina están en la cocina de todos los que quieren recordar una receta de la infancia y darle a cada plato ese toque especial de la cocina casera. Tanto si se trata de ratatouille como de costillas de cerdo, los modelos fabricados en hierro aportan más sabor y versatilidad y además cuentan con un revestimiento interno antiadherente Starflon, que se adapta a los momentos más sencillos y sofisticados de la mesa.





TRAMONTINA



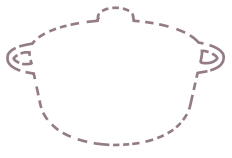

**IRON SAUCE PANS**  
**OLLAS DE HIERRO**

- gas
- electric eléctrica
- ceramic glass (electric heating element) vitrocerámico (resistencia eléctrica)
- induction inducción

**Trento**

- enameled cast iron with interior Starflon Excellent nonstick coating | hierro fundido esmaltado con revestimiento interno antiadherente Starflon Excellent
- stainless steel handles and knobs | mangos y agarradores de acero inoxidable
- quick and even cooking | cocción rápida y uniforme
- much more flavor | mucho más sabor
- oven safe | se puede llevar all horno



watch the video



vea el vídeo

NEW | NUEVO



Frying pan / Sartén - ø 26, 30 cm

Ref.	un.	Kg	m <sup>3</sup>	thick espesor mm	lit.	size tamaño cm	789.1112.	packaging empaque
20836/026*	02	3,92	0,026	2,5	2,1	ø 26	26504.2	
030*		4,96	0,031	2,5	3,0	ø 30	26505.9	

NEW | NUEVO



Skillet with lid / Arrocera con tapa - ø 28 cm

20804/028*	02	10,01	0,026	3,2	4,1	ø 28	29737.1	
------------	----	-------	-------	-----	-----	------	---------	--

NEW | NUEVO



Casserole / Cacerola - ø 24, 28 cm

20805/024*	02	8,92	0,026	3,2	4,0	ø 24	29738.8	
028*		11,73	0,036	3,2	6,0	ø 28	29739.5	

NEW | NUEVO



Wok / Wok - ø 32 cm

20806/032*	02	12,77	0,038	3,0	5,0	ø 32	29740.1	
------------	----	-------	-------	-----	-----	------	---------	--



# THEMED PROJECTS

## PROYECTOS TEMÁTICOS

**A LITTLE FUN ALWAYS MAKES IT BETTER. | UN POCO DE DIVERSIÓN SIEMPRE HACE BIEN.**

**264. Power Up**

**267. My Lovely Kitchen**

Sometimes, all we need to think about new recipes, lighten up the day and finish chores quickly is a little creativity. Cheerful colors and phrases in a well-humored tone, that people identify with and speak during the day, are part of Tramontina's Themed Projects. There are several utensils for cooking – and even training – without rules, in your own way and to make things beautiful whenever you feel like it: every day.

A veces, lo único que necesitamos para pensar en nuevas recetas, aligerar el día y terminar rápidamente las tareas de la casa es de un poco de creatividad. Colores alegres y frases en tono de buen humor, con las que la gente se identifica y habla durante el día, forman parte de los Proyectos Temáticos de Tramontina. Son varios utensilios para cocinar –e incluso entrenar– sin reglas, a su manera y haciendo las cosas bien cuando lo desee: todos los días.







# THEMED PROJECTS

## PROYECTOS TEMÁTICOS



## Power Up

- aluminum with interior Starflon Max nonstick coating and exterior Starflon Max nonstick, silicone or polyester coating | aluminio con revestimiento interno de antiadherente Starflon Max y externo antiadherente Starflon Max, siliconado o poliéster
- heat resistant bakelite handles and nylon knob | mangos, asas de baquelita antitérmica y agarrador de nylon.
- nylon or stainless steel utensils and polypropylene handles | utensilios de nylon o acero inoxidable y mangos de polipropileno
- shaker bottle, measuring cup and spoon, flatware, insulated bag and containers complete the line | coctelera, tazas y cucharas medidoras, cubiertos, bolsa térmica y potes completan la línea



watch the video



vea el vídeo



NEW | NUEVO



### Muffin pan / Molde para muffin

Exterior polyester coating / Revestimiento externo de poliéster

Ref.	un.	Kg	m <sup>3</sup>	thick espesor mm	lit.	size tamaño cm	789.1112.	packaging empaque
27813/050	06	2,13	0,010	1,0	-	-	29991.7	■



NEW | NUEVO



### Deep roasting pan / Asadera rectangular honda - 34 cm

Exterior polyester coating / Revestimiento externo de poliéster

27813/051	06	3,09	0,018	1,0	4,9	39,2x28,2x6,4	29992.4	●
-----------	----	------	-------	-----	-----	---------------	---------	---



NEW | NUEVO



### Flat roasting pan / Asadera rectangular rasa - 34 cm

Exterior polyester coating / Revestimiento externo de poliéster

27813/052	06	2,68	0,014	1,0	2,9	39,2x28,2x3,5	29993.1	●
-----------	----	------	-------	-----	-----	---------------	---------	---

NEW | NUEVO



### Egg frying pan / Sartén para huevo - ø 13 cm

27813/053	12	2,08	0,024	1,2	0,4	ø 13	29994.8	■
-----------	----	------	-------	-----	-----	------	---------	---

NEW | NUEVO



### Omelette pan / Omeletera - ø 20 cm

27813/054	06	3,10	0,032	1,2	0,8 0,9	ø 20	29995.5	■
-----------	----	------	-------	-----	------------	------	---------	---





Glass Ceramic  
(electric heating element)  
Vidroc er mico  
(resistencia el ctrica)

NEW | NUEVO



**Pancake mold/Tapioca pan / Panquequera/Tapiquera -   22 cm**  
Exterior silicone coating / Revestimiento externo siliconado

Ref.	un.	Kg	m <sup>3</sup>	thick espesor mm	lit.	size tama�o cm	789.1112.	packaging empaquet
27813/055	12	4,34	0,036	1,6	0,6	� 22	29996.2	▲



Glass Ceramic  
(electric heating element)  
Vidroc er mico  
(resistencia el ctrica)

NEW | NUEVO



**Frying pan / Sart n -   24 cm**  
Exterior silicone coating / Revestimiento externo siliconado

27813/056	06	3,30	0,036	2,0	1,2	� 24	29997.9	▲
-----------	----	------	-------	-----	-----	------	---------	---



NEW | NUEVO

**Steamer / Cozi-vapore -   16 cm**

27813/057	04	4,39	0,043	1,2 1,4	1,8	� 16	29998.6	■
-----------	----	------	-------	------------	-----	------	---------	---

NEW | NUEVO



**Milk boiler / Hervidor -   14 cm**

27813/058	06	2,87	0,026	1,6	1,9	� 14	30016.3	●
-----------	----	------	-------	-----	-----	------	---------	---

NEW | NUEVO



**Multipurpose tongs/ Pinza multiuso**

Ref.	un.	Kg	m <sup>3</sup>	789.1112.	packaging empaquet
29813/054*	12	1,25	0,007	30001.9	▲

NEW | NUEVO



**Spatula / Esp tula**

29813/055	12	1,35	0,009	30002.6	▲
-----------	----	------	-------	---------	---



**Whisk / Batidor**

Ref.	un.	Kg	m <sup>3</sup>	789.1112.	packaging empaque
29813/056	12	1,21	0,011	30003.3	▲



**Grater / Rallador**

29813/057	12	1,25	0,009	30004.0	▲
-----------	----	------	-------	---------	---

Protective case  
Capa protectora



**Peeler / Pelador**

29813/058	12	1,01	0,005	30005.7	▲
-----------	----	------	-------	---------	---

Protective case  
Capa protectora



Handle for easy carrying /  
Tiene asa para facilitar el transporte

Copolyester shaker bottle /  
Coctelera de copoli ester

**Shaker bottle 3 in 1 with mixer /  
Coctelera 3 en 1 con mezclador**

29813/062	04	1,35	0,014	30006.4	▲
-----------	----	------	-------	---------	---

Compartment for pills, vitamins and  
other supplements / Con compartimento  
para transportar capsulas, vitaminas y  
suplementos adicionales



**4 pcs. Measuring cup set /  
Juego tazas medidoras 4 pzas.**

29899/042	12	2,14	0,026	30007.1	▲
-----------	----	------	-------	---------	---



**5 pcs. Measuring spoon set /  
Juego cucharas medidoras 5 pzas.**

29899/043	12	0,88	0,006	30008.8	▲
-----------	----	------	-------	---------	---



**9 pcs. Thermal bag lunch box set / Juego térmico 9 pzas.**

29899/044	02	2,18	0,021	30043.9	■
-----------	----	------	-------	---------	---

- CONTENTS / CONTENIDO
- 1 - 25080/030 - 300 ml Container / Pote 300 ml
  - 1 - 25080/740 - 300 ml Container / Pote 300 ml
  - 1 - 25081/050 - 600 ml Container / Pote 600 ml
  - 1 - 29813/061 - 800 ml Collapsible / Pote retrátil 800 ml
  - 1 - 29813/050 - 4" Table knife / Cuchillo mesa 4"
  - 1 - 29813/051 - Table fork / Tenedor mesa
  - 1 - 29813/052 - Table spoon / Cuchara mesa
  - 1 - 29813/063 - Flatware case / Estuche para cubiertos
  - 1 - 29813/064 - Insulated bag / Bolsa térmica

## My Lovely kitchen



### THEMED PROJECTS PROYECTOS TEMÁTICOS



gas  
gas



electric  
eléctrica



ceramic glass (electric  
heating element)  
vitrocerámico  
(resistencia eléctrica)

- aluminum with interior Starflon Max nonstick coating and exterior Starflon Max nonstick, silicone or polyester coating | aluminio con revestimiento interno de antiadherente Starflon Max y externo antiadherente Starflon Max, siliconado o poliéster
- heat resistant bakelite handles and nylon knobs | mangos, asas de baquelita antitérmica y agarradores de nylon
- flatware with stainless steel blades and polypropylene handles with patterns on the upperside of the handle | cubiertos con láminas de acero inoxidable y mangos de polipropileno con estampado en la parte superior del mango



watch the video



vea el vídeo



**Deep roasting pan / Asadera rectangular honda - 28 cm**  
Exterior polyester coating / Revestimiento externo de poliéster

Ref.	un.	Kg	m <sup>3</sup>	thick espesor mm	lit.	size tamaño cm	789.1112.	packaging empaque
27807/040	06	1,94	0,011	0,8	3,3	33,3x24,1x6,2	27930.8	●



**Deep roasting pan / Asadera rectangular honda - 34 cm**  
Exterior polyester coating / Revestimiento externo de poliéster

27807/041	06	2,58	0,017	0,8	4,9	39,2x28,2x6,4	27931.5	●
-----------	----	------	-------	-----	-----	---------------	---------	---



**Round baking pan / Molde para hornear - ø 26 cm**

27807/042	06	1,84	0,010	0,8	2,4	26x5,0	27932.2	●
-----------	----	------	-------	-----	-----	--------	---------	---



Glass Ceramic  
(electric heating element)  
Vitrocerámico  
(resistencia eléctrica)



**Pancake mold / Panquequera - ø 22 cm**  
Exterior silicone coating / Revestimiento externo siliconado

27807/044	12	4,41	0,038	1,6	0,6	ø 22	27934.6	▲
-----------	----	------	-------	-----	-----	------	---------	---



**Deep frying pan / Sartén honda - ø 24 cm**  
Exterior polyester coating / Revestimiento externo de poliéster

27807/045	06	4,30	0,051	2,3	2,2	ø 24	27935.3	▲
-----------	----	------	-------	-----	-----	------	---------	---



Glass Ceramic  
(electric heating element)  
Vitrocerámico  
(resistencia eléctrica)



**Frying pan / Sartén - ø 20 cm**

Exterior silicone coating / Revestimiento externo siliconado

Ref.	un.	Kg	m <sup>3</sup>	thick espesor mm	lit.	size tamaño cm	789.1112.	packaging empaque
27807/046	06	2,61	0,027	1,8	0,8	ø 20	27936.0	▲



**Straight frying pan with lid / Sartén recta con tapa - ø 24 cm**  
Exterior polyester coating / Revestimiento externo de poliéster

27807/047	06	5,61	0,069	1,8	2,0	ø 24	27937.7	■
-----------	----	------	-------	-----	-----	------	---------	---



**Pasta cooker / Olla para pasta - ø 22 cm**

27807/048	04	5,06	0,068	1,8	5,7	ø 22	27938.4	■
-----------	----	------	-------	-----	-----	------	---------	---



**Popcorn maker / Olla para hacer palomitas de maíz - ø 20 cm**

27807/049	04	4,75	0,077	1,6	3,5	ø 20	27939.1	●
-----------	----	------	-------	-----	-----	------	---------	---



**Kettle / Tetera - 1,9 L**

27807/050	04	3,20	0,037	1,6	1,9	-	27940.7	■
-----------	----	------	-------	-----	-----	---	---------	---



**16 pcs. Flatware set / Juego de cubiertos 16 pzas.**

Ref.	un.	Kg	m <sup>3</sup>	789.1112.	packaging empaque
29899/090	04	2,40	0,023	27964.3	■
091				27965.0	■

**CONTENTS / CONTENIDO**

- 4 - 29807/050 - 5" Steak knives / Cuchillos para asado 5"
- 4 - 29807/051 - Table forks / Tenedores de mesa
- 4 - 29807/052 - Table spoons / Cucharas de mesa
- 4 - 29807/053 - Tea spoons / Cucharas de té







# PACKAGING TYPES | TIPOS DE EMBALAJE

Display • 12 pcs | pzas. Boxed • Belt | Cinta • Carton box | Caja de cartón • Gift box | Caja de regalo  
 Ind. Box • Sleeve • Clam pack • Blister • Bulk with bar code • Paper blister • Ind. Carded • Sticker | Etiqueta



● Display



▭ 12 pcs | pzas. Boxed



▬ Belt | Cinta



▭ Carton box |  
Caja de cartón



▭ Gift box | Caja de regalo



▭ Ind. box



 Sleeve



 Clam pack



 Blister



 Bulk with bar code



 Paper blister



 Ind. Carded



 Sticker | Etiqueta

# PRODUCT NUMBER INDEX | INDICE NUMÉRICO

Ref.	Pag.	Ref.	Pag.	Ref.	Pag.	Ref.	Pag.
20048/034.....	196	20252/736.....	208	20383/020.....	206	20579/016.....	252
20048/734.....	196	20260/616.....	201	20383/716.....	209	20579/016.....	256
20051/022.....	196	20260/618.....	201	20383/718.....	209	20582/120.....	252
20051/028.....	196	20260/620.....	201	20383/720.....	209	20582/420.....	252
20051/034.....	196	20260/622.....	201	20384/012.....	206	20582/620.....	252
20051/040.....	196	20260/624.....	201	20384/014.....	206	20582/720.....	252
20051/722.....	196	20260/626.....	201	20384/712.....	209	20586/620.....	252
20051/728.....	196	20260/628.....	201	20384/714.....	209	20586/720.....	252
20051/734.....	196	20260/630.....	201	20385/024.....	205	20589/624.....	252
20051/740.....	196	20260/716.....	201	20385/724.....	209	20589/724.....	252
20053/022.....	196	20260/718.....	201	20387/020.....	206	20590/120.....	253
20053/028.....	196	20260/720.....	201	20387/720.....	209	20590/620.....	253
20053/034.....	196	20260/722.....	201	20389/022.....	204	20687/020.....	205
20053/040.....	196	20260/724.....	201	20389/722.....	208	20687/024.....	205
20053/722.....	196	20260/726.....	201	20390/022.....	205	20687/720.....	208
20053/728.....	196	20260/728.....	201	20390/722.....	208	20687/724.....	208
20053/734.....	196	20260/730.....	201	20391/024.....	204	20765/038.....	248
20053/740.....	196	20261/618.....	202	20391/724.....	207	20766/022.....	248
20056/024.....	197	20261/620.....	202	20392/024.....	204	20766/024.....	248
20056/026.....	197	20261/622.....	202	20392/724.....	207	20766/026.....	248
20056/724.....	197	20261/624.....	202	20395/028.....	205	20766/030.....	248
20056/726.....	197	20261/718.....	202	20395/728.....	208	20767/030.....	248
20057/022.....	197	20261/720.....	202	20399/080.....	206	20804/028.....	260
20057/024.....	197	20261/722.....	202	20399/081.....	206	20805/024.....	260
20057/026.....	197	20261/724.....	202	20399/082.....	207	20805/028.....	260
20057/722.....	197	20262/616.....	202	20399/083.....	207	20806/032.....	260
20057/724.....	197	20262/618.....	202	20399/780.....	210	20836/026.....	260
20057/726.....	197	20262/620.....	202	20399/781.....	210	20836/030.....	260
20058/030.....	197	20262/716.....	202	20399/782.....	210	20845/040.....	18
20058/035.....	197	20262/718.....	202	20399/783.....	210	20846/028.....	43
20058/730.....	197	20262/720.....	202	20400/620.....	228	20847/026.....	43
20058/735.....	197	20264/622.....	202	20400/624.....	228	20848/024.....	43
20060/024.....	197	20264/722.....	202	20400/628.....	228	20849/016.....	234
20060/724.....	197	20266/616.....	202	20400/720.....	228	20849/018.....	234
20062/020.....	198	20266/716.....	202	20400/724.....	228	20849/020.....	234
20062/024.....	198	20268/614.....	202	20400/728.....	228	20849/022.....	234
20064/024.....	196	20268/714.....	202	20402/620.....	228	20849/024.....	234
20064/724.....	196	20275/610.....	201	20402/624.....	228	20849/028.....	234
20065/022.....	197	20298/661.....	203	20402/720.....	228	20849/032.....	234
20065/722.....	197	20298/664.....	203	20402/724.....	228	20849/036.....	234
20066/026.....	198	20298/761.....	203	20403/616.....	229	20883/028.....	247
20066/726.....	198	20298/764.....	203	20403/618.....	229	20884/024.....	248
20069/022.....	198	20332/612.....	202	20403/620.....	229	20884/028.....	248
20069/026.....	198	20332/614.....	202	20403/716.....	229	20884/030.....	248
20069/030.....	198	20332/712.....	202	20403/718.....	229	20884/032.....	248
20069/722.....	198	20332/714.....	202	20403/720.....	229	20885/024.....	248
20069/726.....	198	20380/016.....	204	20405/614.....	229	20885/028.....	248
20069/730.....	198	20380/018.....	204	20405/714.....	229	20885/032.....	248
20074/024.....	197	20380/020.....	204	20406/624.....	228	20888/020.....	247
20074/724.....	197	20380/022.....	204	20406/724.....	228	20888/024.....	247
20075/024.....	197	20380/024.....	204	20407/624.....	228	20888/026.....	247
20075/724.....	197	20380/026.....	204	20407/626.....	228	20888/028.....	247
20076/030.....	197	20380/028.....	204	20407/724.....	228	20889/030.....	43
20076/730.....	197	20380/030.....	204	20407/726.....	228	20890/020.....	246
20099/020.....	198	20380/716.....	207	20499/615.....	229	20890/025.....	246
20099/720.....	198	20380/718.....	207	20499/616.....	229	20890/030.....	246
20123/020.....	205	20380/720.....	207	20499/617.....	229	20891/036.....	246
20123/920.....	208	20380/722.....	207	20499/715.....	229	20892/024.....	246
20125/030.....	205	20380/724.....	207	20499/716.....	229	20892/028.....	246
20125/034.....	205	20380/726.....	207	20499/717.....	229	20892/030.....	246
20125/038.....	205	20380/728.....	207	20558/620.....	254	20892/032.....	246
20182/013.....	201	20380/730.....	207	20558/920.....	254	20894/022.....	246
20188/016.....	201	20382/020.....	206	20563/024.....	256	20895/028.....	247
20198/660.....	203	20382/022.....	206	20564/024.....	256	20895/032.....	247
20198/661.....	203	20382/024.....	206	20565/424.....	255	20895/038.....	247
20198/760.....	203	20382/720.....	209	20576/006.....	254	20896/045.....	247
20198/761.....	203	20382/722.....	209	20577/011.....	254	20896/060.....	247
20252/032.....	205	20382/724.....	209	20579/001.....	252	20912/324.....	235
20252/036.....	205	20383/016.....	206	20579/004.....	256	20912/724.....	235
20252/732.....	208	20383/018.....	206	20579/013.....	256	20913/324.....	235

Ref.	Pag.	Ref.	Pag.	Ref.	Pag.	Ref.	Pag.
20913/326.....	235	21131/177.....	77	21188/176.....	28	21413/095.....	22
20913/724.....	235	21131/178.....	77	21188/196.....	28	22200/305.....	49
20913/726.....	235	21131/196.....	77	21189/178.....	28	22200/905.....	49
20914/318.....	235	21131/197.....	77	21189/198.....	28	22202/300.....	49
20914/718.....	235	21131/198.....	77	21190/178.....	28	22202/900.....	49
20931/732.....	239	21134/176.....	77	21190/198.....	28	22203/300.....	49
20940/724.....	238	21134/196.....	77	21191/178.....	28	22203/900.....	49
20940/726.....	238	21136/070.....	22	21191/198.....	28	22207/300.....	49
20940/730.....	238	21136/090.....	22	21192/170.....	29	22207/900.....	49
20941/720.....	238	21137/475.....	46	21192/190.....	29	22210/103.....	80
20943/728.....	239	21137/495.....	46	21193/178.....	29	22210/203.....	80
20951/032.....	239	21138/176.....	77	21193/198.....	29	22210/403.....	80
20951/432.....	239	21138/177.....	77	21198/708.....	25	22210/903.....	80
20960/024.....	238	21138/196.....	77	21198/714.....	29	22211/204.....	80
20960/026.....	238	21138/197.....	77	21198/715.....	23	22212/105.....	80
20960/030.....	238	21139/176.....	77	21198/716.....	23	22212/905.....	80
20960/424.....	238	21139/196.....	77	21198/718.....	21	22213/005.....	38
20960/426.....	238	21140/176.....	77	21198/760.....	29	22214/005.....	38
20960/430.....	238	21140/196.....	77	21198/761.....	29	22215/007.....	80
20961/020.....	238	21141/178.....	26	21198/764.....	30	22215/107.....	80
20961/420.....	238	21141/198.....	26	21198/765.....	30	22216/006.....	80
20963/028.....	239	21146/170.....	77	21198/766.....	30	22216/106.....	80
20963/428.....	239	21146/190.....	77	21198/770.....	30	22217/007.....	80
20999/053.....	239	21147/170.....	78	21198/776.....	26	22217/008.....	80
20999/100.....	242	21147/190.....	78	21198/781.....	31	22217/107.....	80
20999/453.....	239	21148/178.....	78	21198/908.....	25	22217/108.....	80
20999/700.....	242	21148/198.....	78	21198/914.....	29	22218/009.....	81
20999/753.....	239	21152/170.....	140	21198/915.....	23	22219/000.....	81
21100/475.....	46	21152/190.....	140	21198/916.....	23	22219/006.....	81
21100/495.....	46	21154/170.....	140	21198/918.....	21	22219/007.....	81
21100/675.....	46	21154/190.....	140	21198/960.....	29	22219/008.....	81
21101/474.....	46	21155/170.....	140	21198/961.....	29	22219/009.....	81
21101/494.....	46	21155/190.....	140	21198/964.....	30	22219/106.....	81
21102/470.....	46	21156/170.....	140	21198/965.....	30	22219/107.....	81
21102/490.....	46	21156/190.....	140	21198/966.....	30	22219/108.....	81
21102/670.....	46	21157/170.....	140	21198/970.....	30	22228/000.....	38
21103/470.....	47	21157/190.....	140	21198/976.....	26	22229/008.....	81
21103/490.....	47	21158/170.....	141	21198/981.....	31	22229/108.....	81
21103/670.....	47	21158/190.....	141	21199/703.....	23	22230/000.....	81
21104/473.....	47	21159/170.....	141	21199/705.....	48	22231/000.....	81
21104/493.....	47	21159/190.....	141	21199/709.....	23	22231/100.....	81
21105/470.....	47	21160/173.....	47	21199/711.....	24	22232/009.....	81
21105/490.....	47	21160/193.....	47	21199/722.....	26	22233/006.....	81
21106/470.....	47	21161/178.....	141	21199/731.....	24	22233/106.....	81
21106/490.....	47	21161/198.....	141	21199/749.....	21	22234/106.....	81
21107/470.....	47	21162/177.....	141	21199/764.....	21	22270/203.....	82
21107/490.....	47	21162/197.....	141	21199/769.....	21	22271/205.....	82
21107/670.....	47	21163/175.....	141	21199/780.....	48	22299/001.....	49
21109/074.....	22	21163/195.....	141	21199/781.....	78	22299/002.....	39
21109/094.....	22	21164/175.....	141	21199/783.....	78	22299/009.....	39
21109/674.....	24	21164/195.....	141	21199/789.....	25	22299/011.....	39
21109/694.....	24	21165/174.....	141	21199/795.....	26	22299/012.....	40
21110/070.....	22	21165/194.....	141	21199/796.....	25	22299/013.....	40
21110/090.....	22	21166/175.....	141	21199/797.....	25	22299/019.....	82
21110/670.....	24	21166/195.....	141	21199/903.....	23	22299/026.....	82
21110/690.....	24	21168/175.....	141	21199/905.....	48	22299/041.....	82
21115/075.....	22	21168/195.....	141	21199/909.....	23	22299/046.....	40
21115/095.....	22	21169/170.....	29	21199/911.....	24	22299/050.....	49
21116/075.....	22	21169/190.....	29	21199/922.....	26	22299/055.....	40
21116/095.....	22	21175/170.....	29	21199/931.....	24	22299/059.....	39
21117/473.....	47	21175/190.....	29	21199/949.....	21	22300/305.....	50
21117/493.....	47	21177/176.....	172	21199/964.....	21	22300/405.....	50
21118/173.....	76	21177/196.....	172	21199/969.....	21	22300/605.....	36
21118/193.....	76	21179/177.....	77	21199/980.....	48	22300/905.....	50
21121/173.....	76	21179/197.....	77	21199/981.....	78	22302/300.....	50
21121/193.....	76	21180/178.....	28	21199/983.....	78	22302/400.....	50
21122/175.....	76	21180/198.....	28	21199/989.....	25	22302/600.....	36
21122/195.....	76	21185/075.....	28	21199/995.....	26	22302/900.....	50
21125/177.....	76	21185/095.....	28	21199/996.....	25	22303/300.....	50
21125/197.....	76	21186/070.....	28	21199/997.....	25	22303/400.....	50
21126/176.....	76	21186/090.....	28	21399/755.....	173	22303/900.....	50
21126/196.....	76	21187/170.....	28	21399/955.....	173	22307/300.....	50
21131/176.....	77	21187/190.....	28	21413/075.....	22	22307/400.....	50



Ref.	Pag.	Ref.	Pag.	Ref.	Pag.	Ref.	Pag.
22307/900.....	50	22920/008.....	91	23167/300.....	55	23198/718.....	53
22310/103.....	83	22920/105.....	91	23167/310.....	55	23198/722.....	53
22311/204.....	83	22920/106.....	91	23167/370.....	55	23198/731.....	53
22312/005.....	83	22920/107.....	91	23167/400.....	55	23198/739.....	53
22312/105.....	83	22920/108.....	91	23167/410.....	55	23198/775.....	55
22313/005.....	83	22921/006.....	91	23167/470.....	55	23198/918.....	53
22313/105.....	83	22921/007.....	91	23167/900.....	55	23198/922.....	53
22314/006.....	83	22921/008.....	91	23167/910.....	55	23198/931.....	53
22315/006.....	83	22921/106.....	91	23167/930.....	55	23198/939.....	53
22315/008.....	83	22921/107.....	91	23167/970.....	55	23199/062.....	55
22315/106.....	83	22921/108.....	91	23167/980.....	55	23199/069.....	55
22315/108.....	83	22921/186.....	91	23180/304.....	51	23199/162.....	55
22316/008.....	83	22923/005.....	91	23180/334.....	51	23199/169.....	55
22316/108.....	83	22935/108.....	36	23180/374.....	51	23199/362.....	55
22317/008.....	84	22938/108.....	36	23180/394.....	51	23199/762.....	55
22317/108.....	84	22950/000.....	86	23180/404.....	51	23199/769.....	55
22318/006.....	84	22950/002.....	86	23180/434.....	51	23199/862.....	55
22318/106.....	84	22950/005.....	86	23180/474.....	51	23270/411.....	59
22319/006.....	84	22950/006.....	86	23180/494.....	51	23270/415.....	59
22319/106.....	84	22950/007.....	86	23180/904.....	51	23270/465.....	59
22321/105.....	50	22950/008.....	86	23180/934.....	51	23270/477.....	59
22321/905.....	50	22950/009.....	86	23180/974.....	51	23270/485.....	59
22328/007.....	84	22950/105.....	86	23180/994.....	51	23272/410.....	59
22328/107.....	84	22950/106.....	86	23182/300.....	51	23272/411.....	59
22330/100.....	84	22950/107.....	86	23182/330.....	51	23272/460.....	59
22340/003.....	83	22950/108.....	86	23182/370.....	51	23272/477.....	59
22399/001.....	50	22950/109.....	86	23182/390.....	51	23272/480.....	59
22399/003.....	50	22952/008.....	86	23182/400.....	51	23273/410.....	59
22399/012.....	85	22952/009.....	86	23182/430.....	51	23273/411.....	59
22399/018.....	85	22953/005.....	86	23182/470.....	51	23273/460.....	59
22399/028.....	38	22953/006.....	86	23182/490.....	51	23273/477.....	59
22399/030.....	36	22953/007.....	86	23182/900.....	51	23273/480.....	59
22399/037.....	38	22953/008.....	86	23182/930.....	51	23276/410.....	59
22399/074.....	37	22953/009.....	86	23182/970.....	51	23276/411.....	59
22399/075.....	37	22956/006.....	86	23182/990.....	51	23276/460.....	59
22399/076.....	37	22956/106.....	86	23183/300.....	51	23276/477.....	59
22399/082.....	85	22969/008.....	91	23183/330.....	51	23276/480.....	59
22399/088.....	37	22969/108.....	91	23183/370.....	51	23299/183.....	60
22399/089.....	37	22969/188.....	103	23183/390.....	51	23299/383.....	60
22830/003.....	79	23099/832.....	87	23183/400.....	51	23299/683.....	60
22831/006.....	79	23160/304.....	54	23183/430.....	51	23299/783.....	60
22832/008.....	79	23160/314.....	54	23183/470.....	51	23299/883.....	60
22833/008.....	79	23160/374.....	54	23183/490.....	51	23360/305.....	56
22834/008.....	79	23160/404.....	54	23183/900.....	51	23360/315.....	56
22840/106.....	15	23160/414.....	54	23183/930.....	51	23360/322.....	56
22841/110.....	15	23160/474.....	54	23183/970.....	51	23360/344.....	56
22842/112.....	15	23160/904.....	54	23183/990.....	51	23360/366.....	56
22843/108.....	15	23160/914.....	54	23185/400.....	52	23360/375.....	56
22844/110.....	15	23160/934.....	54	23185/430.....	52	23360/385.....	56
22845/107.....	15	23160/974.....	54	23185/470.....	52	23360/405.....	56
22846/100.....	16	23160/984.....	54	23185/490.....	52	23360/415.....	56
22847/100*.....	16	23162/300.....	54	23186/400.....	52	23360/422.....	56
22901/005.....	84	23162/310.....	54	23186/430.....	52	23360/444.....	56
22901/006.....	84	23162/370.....	54	23186/470.....	52	23360/466.....	56
22901/007.....	84	23162/400.....	54	23186/490.....	52	23360/475.....	56
22901/008.....	84	23162/410.....	54	23187/300.....	52	23360/485.....	56
22901/105.....	84	23162/470.....	54	23187/330.....	52	23360/905.....	56
22901/106.....	84	23162/900.....	54	23187/370.....	52	23360/915.....	56
22901/107.....	84	23162/910.....	54	23187/390.....	52	23360/975.....	56
22901/108.....	84	23162/930.....	54	23187/400.....	52	23360/985.....	56
22902/005.....	84	23162/970.....	54	23187/430.....	52	23362/300.....	56
22902/006.....	84	23162/980.....	54	23187/470.....	52	23362/310.....	56
22902/007.....	84	23163/300.....	54	23187/490.....	52	23362/322.....	56
22902/008.....	84	23163/310.....	54	23198/018.....	53	23362/344.....	56
22902/009.....	84	23163/370.....	54	23198/022.....	53	23362/366.....	56
22902/105.....	84	23163/400.....	54	23198/031.....	53	23362/370.....	56
22902/106.....	84	23163/410.....	54	23198/039.....	53	23362/380.....	56
22902/107.....	84	23163/470.....	54	23198/075.....	55	23362/400.....	56
22902/108.....	84	23163/900.....	54	23198/175.....	55	23362/410.....	56
22902/109.....	84	23163/910.....	54	23198/318.....	53	23362/422.....	56
22920/005.....	91	23163/930.....	54	23198/322.....	53	23362/444.....	56
22920/006.....	91	23163/970.....	54	23198/331.....	53	23362/466.....	56
22920/007.....	91	23163/980.....	54	23198/339.....	53	23362/470.....	56

Ref.	Pag.	Ref.	Pag.	Ref.	Pag.	Ref.	Pag.
23362/480.....	56	23398/648.....	58	23425/005.....	89	23498/311.....	92
23362/900.....	56	23398/672.....	58	23425/035.....	89	23498/312.....	92
23362/910.....	56	23398/691.....	58	23425/065.....	89	23498/313.....	92
23362/970.....	56	23398/772.....	58	23425/105.....	89	23498/314.....	93
23362/980.....	56	23398/788.....	58	23425/135.....	89	23498/315.....	93
23363/300.....	57	23398/872.....	58	23425/165.....	89	23498/330.....	62
23363/310.....	57	23399/048.....	58	23426/006.....	89	23498/331.....	94
23363/322.....	57	23399/091.....	58	23426/007.....	89	23498/332.....	94
23363/344.....	57	23399/148.....	58	23426/008.....	89	23498/410.....	35
23363/366.....	57	23399/191.....	58	23426/036.....	89	23498/436.....	35
23363/370.....	57	23399/410.....	58	23426/037.....	89	23498/449.....	35
23363/380.....	57	23399/748.....	58	23426/038.....	89	23498/601.....	62
23363/400.....	57	23399/791.....	58	23426/066.....	89	23498/610.....	92
23363/410.....	57	23399/848.....	58	23426/067.....	89	23498/611.....	92
23363/422.....	57	23399/891.....	58	23426/068.....	89	23498/612.....	92
23363/444.....	57	23410/405.....	61	23426/106.....	89	23498/613.....	92
23363/466.....	57	23410/415.....	61	23426/107.....	89	23498/614.....	93
23363/470.....	57	23410/435.....	61	23426/108.....	89	23498/615.....	93
23363/480.....	57	23410/465.....	61	23426/136.....	89	23498/630.....	62
23363/900.....	57	23410/475.....	61	23426/137.....	89	23498/701.....	62
23363/910.....	57	23412/400.....	61	23426/138.....	89	23498/718.....	173
23363/970.....	57	23412/410.....	61	23426/166.....	89	23498/719.....	173
23363/980.....	57	23412/430.....	61	23426/167.....	89	23498/730.....	62
23365/400.....	57	23412/460.....	61	23426/168.....	89	23498/916.....	93
23365/410.....	57	23412/470.....	61	23427/000.....	89	23498/917.....	93
23365/422.....	57	23413/400.....	61	23427/030.....	89	23499/021.....	64
23365/444.....	57	23413/410.....	61	23427/060.....	89	23499/022.....	64
23365/466.....	57	23413/430.....	61	23427/100.....	89	23499/023.....	64
23365/470.....	57	23413/460.....	61	23427/130.....	89	23499/024.....	64
23365/480.....	57	23413/470.....	61	23427/160.....	89	23499/025.....	64
23366/400.....	57	23417/400.....	61	23428/005.....	90	23499/026.....	64
23366/410.....	57	23417/410.....	61	23428/035.....	90	23499/027.....	64
23366/422.....	57	23417/430.....	61	23428/065.....	90	23499/028.....	64
23366/444.....	57	23417/460.....	61	23428/105.....	90	23499/029.....	64
23366/466.....	57	23417/470.....	61	23428/135.....	90	23499/030.....	64
23366/470.....	57	23419/003.....	88	23428/165.....	90	23499/031.....	64
23366/480.....	57	23419/033.....	88	23429/006.....	90	23499/032.....	64
23367/300.....	57	23419/063.....	88	23429/036.....	90	23499/043.....	64
23367/310.....	57	23419/103.....	88	23429/066.....	90	23499/044.....	64
23367/322.....	57	23419/133.....	88	23429/106.....	90	23499/045.....	64
23367/344.....	57	23419/163.....	88	23429/136.....	90	23499/046.....	64
23367/366.....	57	23420/003.....	88	23429/166.....	90	23500/015.....	97
23367/370.....	57	23420/033.....	88	23430/005.....	90	23500/215.....	97
23367/380.....	57	23420/063.....	88	23430/035.....	90	23500/915.....	97
23367/400.....	57	23420/103.....	88	23430/065.....	90	23511/013.....	97
23367/410.....	57	23420/133.....	88	23430/105.....	90	23511/213.....	97
23367/422.....	57	23420/163.....	88	23430/135.....	90	23511/913.....	97
23367/444.....	57	23421/005.....	88	23430/165.....	90	23512/013.....	97
23367/466.....	57	23421/105.....	88	23431/005.....	90	23512/014.....	97
23367/470.....	57	23422/007.....	88	23431/105.....	90	23512/015.....	97
23367/480.....	57	23422/008.....	88	23440/005.....	90	23512/213.....	97
23367/900.....	57	23422/037.....	88	23440/105.....	90	23512/214.....	97
23367/910.....	57	23422/038.....	88	23442/105.....	90	23512/215.....	97
23367/970.....	57	23422/067.....	88	23443/106.....	90	23512/915.....	97
23367/980.....	57	23422/068.....	88	23444/107.....	90	23521/013.....	98
23375/002.....	57	23422/107.....	88	23445/107.....	91	23522/016.....	98
23375/012.....	57	23422/108.....	88	23498/001.....	62	23522/116.....	98
23375/072.....	57	23422/137.....	88	23498/010.....	92	23527/015.....	97
23375/082.....	57	23422/138.....	88	23498/011.....	92	23527/215.....	97
23375/522.....	57	23422/167.....	88	23498/012.....	92	23527/915.....	97
23375/542.....	57	23422/168.....	88	23498/013.....	92	23528/013.....	97
23375/562.....	57	23423/006.....	89	23498/014.....	93	23528/213.....	97
23398/072.....	58	23423/036.....	89	23498/015.....	93	23529/015.....	97
23398/088.....	58	23423/066.....	89	23498/018.....	173	23529/215.....	97
23398/172.....	58	23423/106.....	89	23498/019.....	173	23650/103.....	95
23398/248.....	58	23423/136.....	89	23498/028.....	94	23651/105.....	95
23398/272.....	58	23423/166.....	89	23498/030.....	62	23652/108.....	95
23398/288.....	58	23424/006.....	89	23498/031.....	94	23653/105.....	95
23398/291.....	58	23424/036.....	89	23498/032.....	94	23654/108.....	95
23398/448.....	58	23424/066.....	89	23498/101.....	62	23655/107.....	95
23398/472.....	58	23424/106.....	89	23498/130.....	62	23656/100.....	95
23398/488.....	58	23424/136.....	89	23498/301.....	62	23657/105.....	96
23398/491.....	58	23424/166.....	89	23498/310.....	92	23658/105.....	96

Ref.	Pag.	Ref.	Pag.	Ref.	Pag.	Ref.	Pag.
23680/103.....	104	23852/105.....	99	24024/007.....	111	24499/812.....	103
23681/105.....	104	23853/106.....	99	24024/107.....	111	24511/085.....	122
23682/108.....	104	23854/105.....	99	24025/007.....	111	24600/085.....	122
23683/106.....	104	23856/106.....	99	24025/107.....	111	24601/014.....	123
23684/108.....	104	23857/106.....	99	24026/107.....	111	24601/015.....	123
23685/107.....	104	23857/107.....	99	24027/008.....	115	24601/054.....	123
23699/050.....	96	23858/108.....	99	24028/007.....	115	24601/055.....	123
23699/051.....	96	23859/107.....	100	24029/000*.....	133	24601/084.....	123
23699/054.....	96	23860/104.....	100	24030/000*.....	133	24601/085.....	123
23699/080.....	105	23860/106.....	100	24031/000*.....	133	24601/185.....	123
23699/081.....	105	23861/106.....	100	24032/010*.....	133	24602/005.....	123
23730/004.....	66	23861/107.....	100	24033/000*.....	133	24602/007.....	123
23730/304.....	66	23861/108.....	100	24034/000*.....	133	24602/015.....	123
23731/004.....	66	23864/106.....	100	24035/000*.....	133	24602/017.....	123
23734/003.....	66	23865/100.....	100	24036/000*.....	133	24602/025.....	123
23735/000.....	66	23866/106.....	99	24039/009.....	115	24602/027.....	123
23736/000.....	66	23868/107.....	100	24048/005.....	108	24602/055.....	123
23737/000.....	66	23899/051.....	100	24048/105.....	108	24602/057.....	123
23737/300.....	66	23899/060.....	101	24049/006.....	108	24602/075.....	123
23738/000.....	67	23899/061.....	101	24049/106.....	108	24602/077.....	123
23739/000.....	67	23899/072.....	101	24070/003*.....	118	24602/085.....	123
23740/000.....	67	23899/078.....	101	24071/005*.....	118	24602/087.....	123
23741/000.....	67	24000/003.....	108	24072/006*.....	118	24602/185.....	123
23742/000.....	66	24000/103.....	108	24072/008*.....	118	24603/086.....	123
23742/300.....	66	24001/003.....	108	24073/008*.....	118	24603/087.....	123
23743/000.....	66	24001/103.....	108	24074/008*.....	118	24603/186.....	123
23743/300.....	66	24002/003.....	108	24077/000*.....	118	24603/187.....	123
23750/004.....	68	24002/103.....	108	24078/008*.....	118	24604/006.....	123
23750/404.....	68	24003/005.....	108	24085/005.....	110	24604/016.....	123
23751/004.....	68	24003/105.....	108	24099/016.....	112	24604/026.....	123
23751/404.....	68	24004/005.....	108	24099/017.....	111	24604/056.....	123
23754/003.....	68	24004/105.....	108	24099/020.....	112	24604/076.....	123
23754/403.....	68	24006/006.....	109	24099/021.....	113	24604/086.....	123
23755/000.....	68	24006/106.....	109	24099/025.....	113	24604/186.....	123
23755/400.....	68	24007/006.....	109	24099/027.....	113	24605/005.....	123
23756/000.....	68	24007/007.....	109	24099/035.....	112	24605/006.....	123
23756/400.....	68	24007/106.....	109	24099/036.....	112	24605/007.....	123
23757/000.....	69	24007/107.....	109	24099/037.....	111	24605/015.....	123
23757/400.....	69	24009/008.....	109	24099/070*.....	119	24605/016.....	123
23758/000.....	69	24009/108.....	109	24099/071*.....	119	24605/017.....	123
23758/400.....	69	24010/004.....	109	24099/078*.....	119	24605/025.....	123
23761/000.....	69	24010/006.....	109	24215/000.....	110	24605/026.....	123
23761/400.....	69	24010/008.....	109	24215/100.....	110	24605/027.....	123
23762/000.....	68	24010/010.....	109	24230/043.....	116	24605/055.....	123
23762/400.....	68	24010/104.....	109	24230/049.....	116	24605/056.....	123
23763/000.....	68	24010/106.....	109	24231/048.....	116	24605/057.....	123
23763/400.....	68	24010/108.....	109	24232/047.....	116	24605/075.....	123
23776/120.....	185	24010/110.....	109	24240/009.....	114	24605/076.....	123
23776/130.....	185	24011/006.....	109	24240/013.....	114	24605/077.....	123
23776/150.....	185	24011/008.....	109	24241/008.....	114	24605/085.....	123
23777/120.....	187	24011/010.....	109	24242/007.....	114	24605/086.....	123
23777/130.....	187	24011/106.....	109	24420/080.....	122	24605/087.....	123
23797/001.....	187	24011/108.....	109	24420/082.....	122	24605/186.....	123
23797/402.....	184	24011/110.....	109	24420/088.....	122	24605/187.....	123
23797/403.....	184	24012/010.....	109	24421/080.....	122	24606/087.....	124
23797/404.....	184	24012/110.....	109	24421/082.....	122	24606/006.....	124
23797/602.....	184	24013/010.....	110	24421/088.....	122	24606/007.....	124
23797/603.....	184	24013/110.....	110	24422/080.....	122	24606/016.....	124
23797/604.....	184	24014/006.....	111	24422/082.....	122	24606/017.....	124
23797/905.....	185	24014/106.....	111	24470/184.....	102	24606/026.....	124
23797/906.....	185	24017/010*.....	110	24471/185.....	102	24606/027.....	124
23797/907.....	186	24017/110*.....	110	24472/186.....	102	24606/056.....	124
23797/908.....	186	24020/004.....	110	24472/188.....	102	24606/057.....	124
23797/909.....	187	24020/005.....	110	24473/180.....	102	24606/076.....	124
23797/910.....	187	24020/007.....	110	24473/187.....	102	24606/077.....	124
23798/042.....	67	24020/104.....	110	24473/188.....	102	24606/086.....	124
23798/046.....	67	24020/105.....	110	24474/186.....	102	24606/087.....	124
23798/050.....	69	24020/107.....	110	24475/180.....	102	24607/000.....	124
23799/039.....	67	24021/005.....	110	24475/188.....	102	24607/002.....	124
23799/071.....	69	24021/105.....	110	24476/180.....	102	24607/006.....	124
23799/077.....	69	24022/005.....	110	24476/188.....	102	24607/007.....	124
23850/103.....	99	24023/006.....	110	24479/184.....	143	24607/008.....	124
23851/103.....	99	24023/106.....	110	24499/811.....	103	24607/010.....	124

Ref.	Pag.	Ref.	Pag.	Ref.	Pag.	Ref.	Pag.
24607/012.....	124	24610/076.....	125	24620/178.....	127	24640/180*.....	132
24607/016.....	124	24610/078.....	125	24620/180.....	127	24641/088.....	132
24607/017.....	124	24610/080.....	125	24620/186.....	127	24641/108.....	100
24607/018.....	124	24610/082.....	125	24620/188.....	127	24641/188.....	132
24607/050.....	124	24610/084.....	125	24621/000.....	128	24642/050*.....	132
24607/052.....	124	24610/086.....	125	24621/002.....	128	24642/052*.....	132
24607/056.....	124	24610/088.....	125	24621/006.....	128	24642/054*.....	132
24607/057.....	124	24610/186.....	125	24621/007.....	128	24642/080*.....	132
24607/058.....	124	24610/188.....	125	24621/008.....	128	24642/082*.....	132
24607/070.....	124	24611/058.....	125	24621/010.....	128	24642/084*.....	132
24607/072.....	124	24611/080.....	125	24621/012.....	128	24642/180*.....	132
24607/076.....	124	24611/082.....	125	24621/016.....	128	24642/182*.....	132
24607/077.....	124	24611/088.....	125	24621/017.....	128	24643/050*.....	132
24607/078.....	124	24612/054.....	126	24621/018.....	128	24643/052*.....	132
24607/080.....	124	24612/084.....	126	24621/020.....	128	24643/080*.....	132
24607/082.....	124	24613/054.....	126	24621/022.....	128	24643/082*.....	132
24607/086.....	124	24613/084.....	126	24621/026.....	128	24644/050.....	131
24607/087.....	124	24614/015.....	126	24621/027.....	128	24644/080.....	131
24607/088.....	124	24614/055.....	126	24621/028.....	128	24646/087.....	130
24607/180.....	124	24614/085.....	126	24621/050.....	128	24651/085.....	130
24607/182.....	124	24615/055.....	126	24621/052.....	128	24652/055.....	130
24607/186.....	124	24615/085.....	126	24621/056.....	128	24652/085.....	130
24607/187.....	124	24616/085.....	126	24621/057.....	128	24653/086.....	130
24607/188.....	124	24619/010.....	126	24621/058.....	128	24655/056.....	130
24608/050.....	124	24619/016.....	126	24621/070.....	128	24655/086.....	130
24608/052.....	124	24619/018.....	126	24621/072.....	128	24658/100.....	35
24608/056.....	124	24619/020.....	126	24621/076.....	128	24658/110.....	35
24608/058.....	124	24619/026.....	126	24621/077.....	128	24660/016.....	130
24608/080.....	124	24619/028.....	126	24621/078.....	128	24660/056.....	130
24608/082.....	124	24619/050.....	126	24621/080.....	128	24660/086.....	130
24608/086.....	124	24619/056.....	126	24621/081.....	128	24661/056.....	130
24608/088.....	124	24619/058.....	126	24621/082.....	128	24661/086.....	130
24608/186.....	124	24619/080.....	126	24621/086.....	128	24662/055.....	130
24609/000.....	125	24619/086.....	126	24621/087.....	128	24662/056.....	130
24609/002.....	125	24619/088.....	126	24621/088.....	128	24662/085.....	130
24609/004.....	125	24620/000.....	127	24621/089.....	128	24662/086.....	130
24609/006.....	125	24620/006.....	127	24621/180.....	128	24663/016.....	131
24609/008.....	125	24620/008.....	127	24621/186.....	128	24663/056.....	131
24609/010.....	125	24620/010.....	127	24621/187.....	128	24663/086.....	131
24609/012.....	125	24620/016.....	127	24621/188.....	128	24664/080.....	131
24609/014.....	125	24620/018.....	127	24621/189.....	128	24664/082.....	131
24609/016.....	125	24620/020.....	127	24622/088.....	127	24664/088.....	131
24609/018.....	125	24620/026.....	127	24623/084.....	127	24667/085.....	131
24609/020.....	125	24620/028.....	127	24624/116.....	128	24670/184.....	142
24609/022.....	125	24620/040.....	127	24624/156.....	128	24671/180.....	142
24609/024.....	125	24620/046.....	127	24624/186.....	128	24671/182.....	142
24609/026.....	125	24620/048.....	127	24625/083.....	128	24671/184.....	142
24609/028.....	125	24620/050.....	127	24625/084.....	128	24671/186.....	142
24609/050.....	125	24620/056.....	127	24625/183.....	128	24671/188.....	142
24609/052.....	125	24620/058.....	127	24625/184.....	128	24672/185.....	142
24609/054.....	125	24620/070.....	127	24626/083.....	129	24673/186.....	142
24609/056.....	125	24620/076.....	127	24626/183.....	129	24674/185.....	142
24609/058.....	125	24620/078.....	127	24627/080.....	129	24675/186.....	142
24609/070.....	125	24620/080.....	127	24627/082.....	129	24676/186.....	142
24609/072.....	125	24620/086.....	127	24627/088.....	129	24677/187.....	143
24609/074.....	125	24620/088.....	127	24627/180.....	129	24678/188.....	143
24609/076.....	125	24620/100.....	127	24627/182.....	129	24679/189.....	143
24609/078.....	125	24620/106.....	127	24627/188.....	129	24680/189.....	143
24609/080.....	125	24620/108.....	127	24628/082.....	129	24681/180.....	143
24609/082.....	125	24620/110.....	127	24628/084.....	129	24681/182.....	143
24609/084.....	125	24620/116.....	127	24628/086.....	129	24686/180.....	143
24609/086.....	125	24620/118.....	127	24635/055.....	129	24687/080.....	143
24609/088.....	125	24620/120.....	127	24635/056.....	129	24690/000.....	131
24609/180.....	125	24620/126.....	127	24635/085.....	129	24693/080.....	144
24609/182.....	125	24620/128.....	127	24635/086.....	129	24693/081.....	144
24609/188.....	125	24620/140.....	127	24636/056.....	129	24693/082.....	144
24610/010.....	125	24620/146.....	127	24636/076.....	129	24699/816.....	132
24610/016.....	125	24620/148.....	127	24636/086.....	129	24699/825.....	35
24610/018.....	125	24620/150.....	127	24637/086.....	129	25029/180*.....	159
24610/050.....	125	24620/156.....	127	24637/186.....	129	25053/170.....	191
24610/056.....	125	24620/158.....	127	24638/056.....	129	25053/180.....	191
24610/058.....	125	24620/170.....	127	24638/086.....	129	25056/160.....	159
24610/070.....	125	24620/176.....	127	24640/080*.....	132	25056/170.....	159

Ref.	Pag.	Ref.	Pag.	Ref.	Pag.	Ref.	Pag.
25057/160.....	159	25264/120.....	154	25599/013*.....	172	25654/100.....	158
25057/170.....	159	25264/170.....	154	25599/370.....	152	25654/170.....	158
25058/100.....	17	25550/100.....	170	25599/670.....	152	25654/180.....	158
25099/022.....	65	25550/170.....	170	25599/770.....	152	25655/100.....	158
25099/722.....	65	25551/100.....	170	25601/100.....	155	25655/170.....	158
25099/940.....	191	25551/170.....	170	25601/170.....	155	25655/180.....	158
25099/942.....	191	25552/100.....	170	25601/180.....	155	25674/100.....	158
25099/943.....	191	25552/170.....	170	25603/100.....	155	25674/170.....	158
25099/975.....	190	25553/100*.....	171	25603/170.....	155	25680/101.....	159
25099/976.....	190	25554/100*.....	171	25603/180.....	155	25680/102.....	159
25099/977.....	190	25555/100*.....	171	25605/100.....	155	25680/103.....	159
25099/978.....	191	25556/100*.....	171	25605/170.....	155	25681/100.....	160
25099/979.....	190	25570/130.....	148	25605/180.....	155	25682/100*.....	160
25099/980.....	190	25570/160.....	148	25607/100.....	155	25683/100*.....	160
25106/400.....	159	25570/170.....	148	25607/170.....	155	25684/100*.....	160
25106/470.....	159	25571/130.....	148	25607/180.....	155	25685/100.....	157
25106/480.....	159	25571/160.....	148	25610/100.....	155	25685/170.....	157
25110/180*.....	159	25571/170.....	148	25610/170.....	155	25685/180.....	157
25155/100.....	161	25572/130.....	149	25610/180.....	155	25687/000*.....	116
25155/160.....	161	25572/160.....	149	25611/100.....	156	25690/100.....	158
25155/170.....	161	25572/170.....	149	25611/170.....	156	25690/170.....	158
25156/100.....	161	25573/130.....	149	25611/180.....	156	25691/100.....	158
25156/160.....	161	25573/160.....	149	25621/100.....	156	25691/170.....	158
25156/170.....	161	25573/170.....	149	25621/170.....	156	25692/100.....	158
25157/100.....	161	25574/130.....	149	25621/180.....	156	25692/170.....	158
25157/160.....	161	25574/160.....	149	25623/100.....	156	25693/100.....	158
25157/170.....	161	25574/170.....	149	25623/170.....	156	25693/170.....	158
25158/100.....	161	25575/130.....	149	25623/180.....	156	25694/100.....	159
25158/160.....	161	25575/160.....	149	25624/100.....	156	25694/170.....	159
25158/170.....	161	25575/170.....	149	25624/170.....	156	25695/100.....	159
25159/100.....	161	25576/130.....	149	25624/180.....	156	25695/170.....	159
25159/160.....	161	25576/160.....	149	25625/100.....	156	25695/180.....	159
25159/170.....	161	25576/170.....	149	25625/170.....	156	25731/120*.....	147
25160/100.....	162	25577/130.....	150	25625/180.....	156	25731/160*.....	147
25160/160.....	162	25577/160.....	150	25626/102.....	156	25732/120*.....	147
25160/170.....	162	25577/170.....	150	25626/103.....	156	25732/160*.....	147
25161/100.....	162	25578/130*.....	150	25626/172.....	156	25733/120*.....	147
25161/160.....	162	25578/160*.....	150	25626/173.....	156	25733/160*.....	147
25161/170.....	162	25578/170*.....	150	25626/182.....	156	25734/120*.....	147
25162/100.....	162	25579/130.....	150	25626/183.....	156	25734/160*.....	147
25162/160.....	162	25579/160.....	150	25627/100.....	156	25735/120*.....	147
25162/170.....	162	25579/170.....	150	25627/170.....	156	25735/160*.....	147
25163/100.....	162	25580/130.....	150	25627/180.....	156	25751/110.....	164
25163/160.....	162	25580/160.....	150	25631/100.....	156	25751/160.....	164
25163/170.....	162	25580/170.....	150	25631/170.....	156	25751/190.....	164
25164/100.....	162	25581/130*.....	150	25631/180.....	156	25752/110.....	164
25164/160.....	162	25582/130.....	151	25632/100.....	157	25752/160.....	164
25164/170.....	162	25582/160.....	151	25632/170.....	157	25752/190.....	164
25165/100.....	162	25582/170.....	151	25632/180.....	157	25753/110.....	164
25165/160.....	162	25583/130.....	151	25633/100.....	157	25753/160.....	164
25165/170.....	162	25583/160.....	151	25633/170.....	157	25753/190.....	164
25166/100.....	162	25583/170.....	151	25633/180.....	157	25754/110.....	165
25166/160.....	162	25584/130.....	151	25638/100.....	157	25754/160.....	165
25166/170.....	162	25584/160.....	151	25638/170.....	157	25754/190.....	165
25199/007.....	163	25584/170.....	151	25638/180.....	157	25755/110.....	165
25199/011.....	163	25585/130.....	151	25640/100.....	157	25755/160.....	165
25199/607.....	163	25585/160.....	151	25640/170.....	157	25755/190.....	165
25199/611.....	163	25585/170.....	151	25640/180.....	157	25756/110.....	165
25199/707.....	163	25586/130.....	151	25641/100.....	157	25756/160.....	165
25199/711.....	163	25586/160.....	151	25641/170.....	157	25756/190.....	165
25260/100.....	153	25586/170.....	151	25641/180.....	157	25785/100*.....	166
25260/170.....	153	25587/130.....	152	25650/100.....	157	25799/150.....	165
25261/100.....	153	25587/160.....	152	25650/170.....	157	25799/650.....	165
25261/120.....	153	25587/170.....	152	25650/180.....	157	25799/950.....	165
25261/170.....	153	25588/131.....	152	25651/100.....	157	25800/100*.....	166
25262/100.....	153	25588/132.....	152	25651/170.....	157	25801/100*.....	166
25262/120.....	153	25588/161.....	152	25651/180.....	157	25802/100*.....	166
25262/170.....	153	25588/162.....	152	25652/100.....	158	25803/100*.....	166
25263/100.....	154	25588/171.....	152	25652/170.....	158	25804/100*.....	166
25263/120.....	154	25588/172.....	152	25652/180.....	158	25807/100*.....	166
25263/170.....	154	25599/010.....	171	25653/100.....	158	25808/100*.....	166
25264/100.....	154	25599/011.....	171	25653/170.....	158	25810/160*.....	145
		25599/012*.....	172	25653/180.....	158	25811/160*.....	145



Ref.	Pag.	Ref.	Pag.	Ref.	Pag.	Ref.	Pag.
25812/160*	145	26418/065	31	26593/100*	16	28504/720	216
25813/160*	145	26418/075	31	26594/100	16	28504/722	216
25814/160*	145	26418/085	31	26595/100	16	28504/724	216
25815/160*	145	26418/095	31	26596/100	13	28505/622	212
25816/160*	145	26419/065	31	26599/001	27	28505/624	212
25816/161*	146	26419/075	31	27806/001	199	28505/722	216
25817/160*	146	26419/085	31	27806/002	199	28505/724	216
25817/161*	146	26419/095	31	27806/003	199	28506/628	212
25818/160*	146	26440/108	32	27806/004	199	28506/728	216
25819/160*	146	26441/100	32	27806/005	199	28508/618	211
25830/100*	167	26442/100	32	27806/006	199	28508/620	211
25831/100*	167	26443/100	32	27806/007	199	28508/622	211
25832/100*	167	26444/107	32	27806/008	200	28508/624	211
25833/100*	167	26445/100	32	27806/009	200	28508/626	211
25835/100*	167	26446/100	32	27806/011	220	28508/628	211
25836/100*	167	26456/008*	17	27806/012	220	28508/630	211
25837/100*	167	26456/010*	18	27806/013	220	28508/720	215
25840/100*	167	26460/100*	33	27806/014	220	28508/724	215
25841/100*	167	26461/100*	33	27806/015	220	28508/728	215
25900/144	176	26462/100*	33	27806/016	220	28509/624	212
25901/105	176	26463/100*	33	27806/017	220	28509/628	212
25901/145	176	26464/110	91	27806/018	221	28509/724	216
25905/166	180	26464/111	91	27806/019	221	28509/728	216
25910/145	180	26466/100	33	27806/020	221	28515/628	212
25910/146	180	26467/100	32	27806/021	221	28515/728	216
25910/165	180	26468/100	32	27806/022	221	28517/624	212
25910/166	180	26469/100	31	27806/023	221	28517/724	216
25911/146	180	26479/100*	33	27806/024	221	28518/624	212
25911/166	180	26480/001*	41	27806/025	221	28518/626	212
25919/168	179	26480/002*	41	27806/027	221	28518/724	217
25920/169	179	26480/003*	41	27807/040	267	28518/726	217
25923/088	131	26481/002*	41	27807/041	267	28524/618	213
25924/088	131	26481/003*	41	27807/042	267	28524/620	213
25925/160	178	26483/000*	41	27807/044	267	28524/622	213
25925/167	178	26484/000*	42	27807/045	267	28524/624	213
25925/168	178	26485/000*	42	27807/046	268	28524/626	213
25926/160	178	26486/000*	42	27807/047	268	28524/628	213
25926/168	178	26490/003*	42	27807/048	268	28524/718	217
25929/995	177	26494/000	18	27807/049	268	28524/720	217
25930/995	177	26495/000	18	27807/050	268	28524/722	217
25950/147	179	26499/002	31	27813/050	264	28524/724	217
25950/148	179	26499/003	31	27813/051	264	28524/726	217
25980/005*	181	26499/005	31	27813/052	264	28524/728	217
25981/006*	181	26499/032	34	27813/053	264	28525/616	213
25982/005*	181	26499/035	34	27813/054	264	28525/618	213
25985/005*	181	26499/036	34	27813/055	265	28525/620	213
25986/006*	181	26499/037	34	27813/056	265	28525/622	213
25987/006*	181	26499/042*	33	27813/057	265	28525/716	217
25999/010	177	26499/044	34	27813/058	265	28525/718	217
25999/409	176	26499/045	34	27899/038	200	28525/720	217
25999/410	177	26499/046	34	27899/039	200	28525/722	217
25999/913	177	26500/003	12	27899/040	222	28530/616	213
26003/106	135	26500/006	13	27899/041	222	28530/618	213
26010/105	135	26500/009	12	28099/600	214	28530/620	213
26010/106	135	26500/011	14	28099/700	219	28530/622	213
26011/105	135	26500/021*	14	28500/618	211	28530/624	213
26051/105	136	26500/029	14	28500/620	211	28530/626	213
26053/106	136	26500/061	14	28500/622	211	28530/628	213
26081/108	136	26500/062*	15	28500/624	211	28530/716	217
26099/081	136	26500/065	13	28500/626	211	28530/718	217
26300/003	134	26500/066	13	28500/628	211	28530/720	217
26301/003	134	26570/000*	17	28500/630	211	28530/722	217
26325/103	134	26571/000*	17	28500/718	215	28530/724	217
26330/100	170	26580/108	27	28500/720	215	28530/726	217
26330/170	170	26581/100	27	28500/722	215	28530/728	217
26337/100*	171	26582/100	27	28500/724	215	28531/610	213
26400/100	32	26583/100	27	28500/726	215	28531/612	213
26400/101	32	26584/100	27	28500/728	215	28531/614	213
26417/055	31	26585/100	27	28500/730	215	28531/616	213
26417/065	31	26590/108	16	28504/620	211	28531/710	217
26417/075	31	26591/100	16	28504/622	211	28531/712	217
26417/085	31	26592/100	16	28504/624	211	28531/714	217

Ref.	Pag.	Ref.	Pag.
28531/716.....	217	29810/198.....	46
28532/614.....	213	29813/054.....	265
28532/616.....	213	29813/055.....	265
28532/714.....	217	29813/056.....	266
28532/716.....	217	29813/057.....	266
28534/619.....	224	29813/058.....	266
28534/719.....	224	29813/062.....	266
28535/624.....	213	29899/042.....	266
28535/724.....	218	29899/043.....	266
28536/622.....	214	29899/044.....	266
28536/722.....	218	29899/060*.....	160
28538/622.....	214	29899/061*.....	160
28538/722.....	218	29899/062*.....	160
28545/632.....	214	29899/063.....	198
28545/636.....	214	29899/090.....	268
28545/732.....	218	29899/091.....	268
28545/736.....	218	29899/126.....	63
28594/119.....	224	29899/127.....	63
28594/419.....	224	29899/128.....	63
28595/322.....	224	29899/129.....	63
28596/123.....	223	29899/502.....	19
28596/323.....	223	29899/511.....	19
28596/923.....	223	29899/514.....	19
28599/600.....	215	29899/517.....	19
28599/601.....	215	29899/520.....	20
28599/602.....	215	29899/529.....	20
28599/611.....	214	29899/532.....	20
28599/700.....	219	29899/559.....	20
28599/701.....	219		
28599/702.....	219		
28599/711.....	218		
28699/201.....	243		
28699/401.....	243		
28700/020.....	232		
28700/024.....	232		
28700/026.....	232		
28700/028.....	232		
28700/720.....	232		
28700/724.....	232		
28700/726.....	232		
28700/728.....	232		
28701/022.....	232		
28701/722.....	232		
28702/024.....	232		
28702/724.....	232		
28703/024.....	233		
28703/724.....	233		
28704/024.....	233		
28704/724.....	233		
28705/020.....	233		
28705/022.....	233		
28705/024.....	233		
28705/028.....	233		
28705/720.....	233		
28705/722.....	233		
28705/724.....	233		
28705/728.....	233		
28706/018.....	233		
28706/020.....	233		
28706/718.....	233		
28706/720.....	233		
28707/028.....	233		
28707/728.....	233		
28708/032.....	234		
28708/732.....	234		
28709/022.....	234		
28709/722.....	234		
28799/001.....	234		
28799/002.....	234		
28799/701.....	234		
28799/702.....	234		
29810/014.....	22		
29810/197.....	46		

**NOTES | NOTAS**



A series of horizontal lines for writing, consisting of 25 evenly spaced lines extending across the width of the page.







# TRAMONTINA

## GENERAL INFORMATION | INFORMACIÓN GENERAL

### Product Image

Some images presented in this catalog are merely illustrative.

### Product modifications

Tramontina reserves the right to modify any product present in this catalog, with the aim of improving it whenever there are technical or commercial reasons for doing so. Any changes that are carried out are exempt from prior notices and do not require the replacement of products already sold.

### Items canceled or discontinued

Tramontina reserves the right to withdraw from production or cancel the sale of any product in this file.

### Measurements and weights

The values relating to weights and measurements contained in this file are subject to change.

### Certificate of origin

Some products are outsourced through production agreements that follow strict quality standards, controls, specifications with Tramontina warranty. These products are marked in reference with an \* (Certificate of Origin not available) in this file. In this way, seeking permanent renewal, the company offers a guarantee of credibility in national and international markets.

### Imagen del Producto

Algunas imágenes presentadas en este catálogo son meramente ilustrativas.

### Modificaciones en los productos

Tramontina se reserva el derecho de modificar cualquier producto presente en este catálogo, con el objetivo de mejorarlo siempre que existan razones técnicas o comerciales para hacerlo. Los cambios que se realicen están exentos de aviso previo y no requieren la sustitución de los productos ya vendidos.

### Artículos cancelados o discontinuados

Tramontina se reserva el derecho de retirar la producción o cancelar la comercialización de cualquier producto de este archivo.

### Medidas y pesos

Los valores relativos a los pesos y medidas que se incluyen en este archivo están sujetos a cambios.

### Certificado de origen

Algunos productos son tercerizados a través de acuerdos de producción que siguen estrictas normas de calidad, controles, especificaciones con la garantía de Tramontina. Estos productos están marcados en la referencia con un \*(Certificado de Origen no disponible) en este archivo. De este modo, buscando la renovación permanente, la empresa ofrece una garantía de credibilidad en los mercados nacionales e internacionales.

## BANK DETAILS

### Conditions of Sale

- 1• Prices are net and FOB Rio Grande port.
- 2• Minimum order requirement is US\$ 6.000,00. If the total order amount is less than minimum, the system will automatically add the amount of US\$ 200,00 as internal charges.
- 3• It's recommended always to purchase in 20' or 40' containers for easier handling.
- 4• Quantities less than the standard cartons will be automatically increased to the master carton quantity.
- 5• Country of origin: Brazil.
- 6• Payment for merchandise is requested through irrevocable Letter of Credit at sight or T.T. in advance.
- 7• When the payment is effected through Letter of Credit please indicate either one of our following bankers as the advising Bank in Brazil in order to avoid unnecessary bank charges.

#### **Banco Santander Brasil S.A.**

Rua Amador Bueno, 474 - 04752-005 - Santo Amaro  
São Paulo - SP - Brasil  
Swift: BSCHBRSP

#### **Banco Itaú S.A.**

Head Office  
Praça Alfredo Egideo de Souza Aranha, 100, Torre ITAUSA  
SÃO PAULO - SP - Brasil  
Tel.: (011) 3274.9009 Swift: ITAUBRSP

And follow these instructions for L/C application:

- Credits must be confirmed, irrevocable, unrestricted and payable at sight;
- Validity for shipment of 90 days with additional 21 days for maturity;
- Shipments from South Brazilian Ports;
- Transshipment an partial shipment allowed.

- 8• When the payment is effected through T.T. please consider either one of the following Banks:

#### **Standard Chartered Bank**

New York - NY - USA Branch  
Swift: SCBLUS33  
IBAN: BR83 6070 1190 0028 0000 0102 146C1  
FED ABA CODE: 026002561  
ACCOUNT: 3544-030205-001  
Beneficiary Bank: Banco Itaú BBA S/A  
Account Number: 10214-6  
Agency: 0280  
São Paulo Head-Office  
SWIFT CODE: ITAUBRSPNHO  
Reference Invoice N°  
Beneficiary: Tramontina S.A. Cutelaria

#### **Standard Chartered Bank**

New York - NY - USA  
Swift: SCBLUS33  
IBAN: BR96 9040 0888 0100 2013 0000 102C1  
FED ABA CODE: 026002561  
ACCOUNT: 3544-034644-001  
Beneficiary Bank: Banco Santander Brasil S/A  
Account Number: 13000010-2  
Agency: 1002  
SWIFT CODE: BSCHBRSP  
Reference Invoice N°  
Beneficiary: Tramontina S.A. Cutelaria

#### **Banco do Brasil**

New York - NY - USA  
Swift: BRASUS33  
IBAN: BR86000000000 3168 0000509000C1  
Beneficiary Bank: Banco do Brasil SA Curitiba  
SWIFT CODE: BRASBRRTCTA  
Reference Invoice N°  
Beneficiary: Tramontina S.A. Cutelaria

### Condiciones de Venta

- 1• Los precios son netos y FOB en el puerto de Rio Grande.
- 2• El pedido mínimo requerido es US\$ 6.000,00. Si el monto del pedido es menor al mínimo requerido, nuestro sistema automáticamente cargará US\$ 200,00 como carga extra.
- 3• Sugerimos a nuestros clientes que siempre compren contenedores de 20' ó 40' para su fácil manejo.
- 4• Los pedidos menores al standard de cartón automáticamente serán aumentados a la cantidad más cercana del standard.
- 5• País de origen: Brasil.
- 6• El pago por mercancía es requerido, en forma de Carta de Crédito irrevocable a la vista o T.T. por adelantado.
- 7• Cuando el pago sea efectuado a través de Carta de Crédito, por favor indique uno de los bancos que a continuación se enlistan. Tome como referencia uno de ellos para evitar cargos bancarios innecesarios.

#### **Banco Santander Brasil S.A.**

Rua Amador Bueno, 474 - 04752-005 - Santo Amaro  
São Paulo - SP - Brasil  
Swift: BSCHBRSP

#### **Banco Itaú S.A.**

Head Office  
Praça Alfredo Egideo de Souza Aranha, 100, Torre ITAUSA  
SÃO PAULO - SP - Brasil  
Tel.: (011) 3274.9009 Swift: ITAUBRSP

Siga éstas instrucciones para solicitud de Carta de Crédito:

- Los créditos deben ser confirmados, irrevocables y pagaderos a la vista;
- Válidos por un periodo de 90 días, con 21 días adicionales para su negociación;
- Embarque en puertos del sur de Brasil;
- Transbordos y embarques parciales concedidos.

- 8• Cuando el pago sea efectuado por T.T. por favor considere uno de los siguientes bancos:

#### **Standard Chartered Bank**

New York - NY - USA Branch  
Swift: SCBLUS33  
IBAN: BR83 6070 1190 0028 0000 0102 146C1  
FED ABA CODE: 026002561  
ACCOUNT: 3544-030205-001  
Beneficiary Bank: Banco Itaú BBA S/A  
Account Number: 10214-6  
Agency: 0280  
São Paulo Head-Office  
SWIFT CODE: ITAUBRSPNHO  
Reference Invoice N°  
Beneficiary: Tramontina S.A. Cutelaria

#### **Standard Chartered Bank**

New York - NY - USA  
Swift: SCBLUS33  
IBAN: BR96 9040 0888 0100 2013 0000 102C1  
FED ABA CODE: 026002561  
ACCOUNT: 3544-034644-001  
Beneficiary Bank: Banco Santander Brasil S/A  
Account Number: 13000010-2  
Agency: 1002  
SWIFT CODE: BSCHBRSP  
Reference Invoice N°  
Beneficiary: Tramontina S.A. Cutelaria

#### **Banco do Brasil**

New York - NY - USA  
Swift: BRASUS33  
IBAN: BR86000000000 3168 0000509000C1  
Beneficiary Bank: Banco do Brasil SA Curitiba  
SWIFT CODE: BRASBRRTCTA  
Reference Invoice N°  
Beneficiary: Tramontina S.A. Cutelaria

# TRAMONTINA

## BANK DETAILS

If the payment is in Euros, please send it to:

**BNP - PARIBAS SA**

Paris - France  
 Swift Code: BNPAFRPP  
 Credit to: Banco Itaú S/A – São Paulo Head-Office  
 under advice to Porto Alegre branch  
 Swift Code: CBBABRSP  
 Account Number: 10214-6  
 Agency: 0280  
 Beneficiary: Tramontina S.A. Cutelaria  
 Invoice Number:.....

**Banco Santander Central Hispano**

Madrid - Spain  
 Account: 15439  
 Swift Code: BSCHEMMS  
 Credit to: Banco Santander Brasil S/A – São Paulo Head-Office  
 under advice to Porto Alegre branch  
 Swift Code: BSCHBRSP  
 Beneficiary: Tramontina S.A. Cutelaria  
 Invoice Number:.....

**Banco do Brasil**

Frankfurt  
 Swift Code: BRASDEFF  
 Credit to: Banco do Brasil SA  
 Curitiba  
 Swift Code: BRASBRRTCTA  
 Beneficiary: Tramontina S.A. Cutelaria  
 Invoice Number:.....

9• Always forward to us the letter of credit draft before opening.  
 Otherwise L/C amendment charges will be on buyer's account.

10• L/C confirmation charge and all other bank charges outside Brazil  
 are on buyer's account.

11• Tramontina only use wood from reforestation and legally  
 sourcing areas.

Si el pago es en euros, considere uno de los siguientes bancos:

**BNP - PARIBAS SA**

Paris - France  
 Swift Code: BNPAFRPP  
 Credit to: Banco Itaú S/A – São Paulo Head-Office  
 under advice to Porto Alegre branch  
 Swift Code: CBBABRSP  
 Account Number: 10214-6  
 Agency: 0280  
 Beneficiary: Tramontina S.A. Cutelaria  
 Invoice Number:.....

**Banco Santander Central Hispano**

Madrid - Spain  
 Account: 15439  
 Swift Code: BSCHEMMS  
 Credit to: Banco Santander Brasil S/A – São Paulo Head-Office  
 under advice to Porto Alegre branch  
 Swift Code: BSCHBRSP  
 Beneficiary: Tramontina S.A. Cutelaria  
 Invoice Number:.....

**Banco do Brasil**

Frankfurt  
 Swift Code: BRASDEFF  
 Credit to: Banco do Brasil SA  
 Curitiba  
 Swift Code: BRASBRRTCTA  
 Beneficiary: Tramontina S.A. Cutelaria  
 Invoice Number:.....

9• Siempre enviar el borrador de la Carta de Crédito para  
 verificarla antes de aprobarla. De lo contrario, las enmiendas a la  
 Carta de Crédito serán cargadas a la cuenta del comprador.

10• Los gastos por confirmación L/C bancarios realizados  
 fuera de Brasil corren por cuenta del comprador.

11• Tramontina solamente utiliza madera reforestada y de áreas legales.





## TRAMONTINA

### TRAMONTINA S.A. CUTELARIA

Av. Ivo Tramontina, 1024  
Bairro Triângulo | CEP 95185-000  
Carlos Barbosa | RS | Brasil  
CNPJ 90.050.238/0001-14  
Indústria Brasileira



TRAMONTINA.COM.BR



/TRAMONTINA



/TRAMONTINA



/TRAMONTINA



@TRAMONTINAOFICIAL